

# DIAGNOSTICS & SUCTION INSTRUMENTS

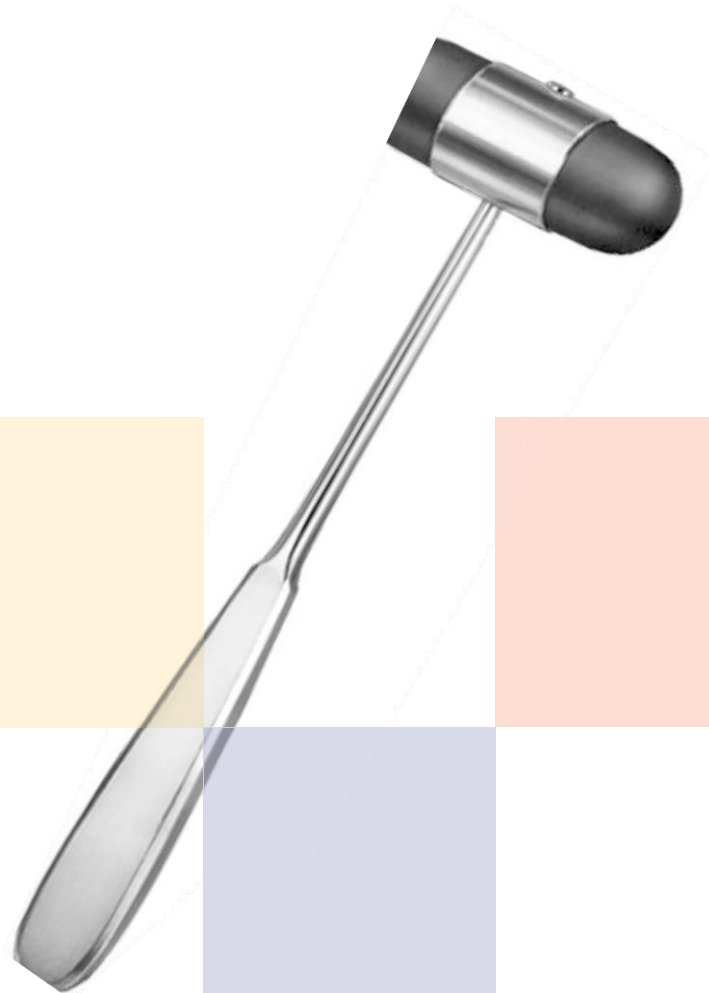

Percussion Hammers



1/2

BUCK  
 01-001-180  
 18 cm / 7"

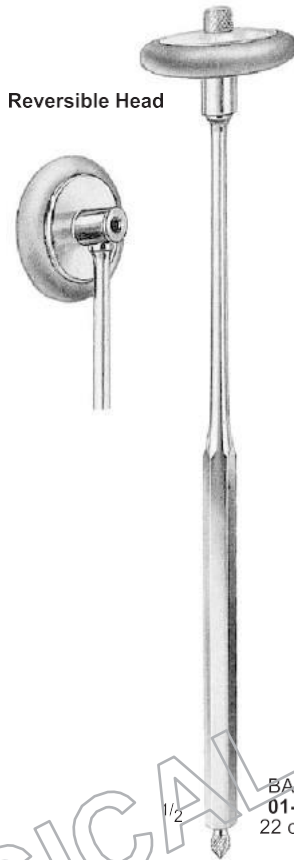

Reversible Head

1/2

BABINSKY  
 01-002-220  
 22 cm / 8 3/4"



1/2

DEJRINE  
 01-003-210  
 21 cm / 8 1/4"

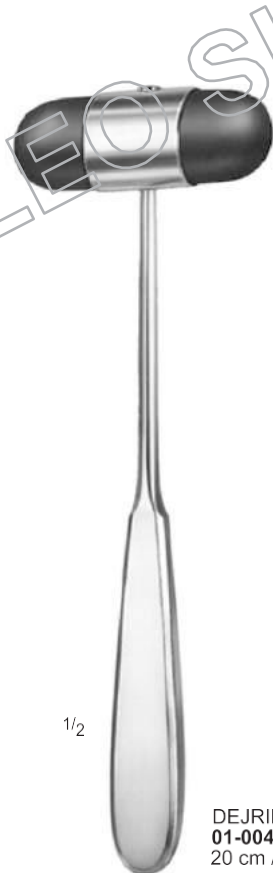

1/2

DEJRINE  
 01-004-200  
 20 cm / 8"



1/2

TROEMNER  
 01-005-250  
 25 cm / 10"



1/2

BERLINER  
 01-006-200  
 20 cm / 8"



1/2

TAYLOR  
 01-007-200  
 20 cm / 8"

LEO SURGICAL COMPANY

Foetal Stethoscope, Pin Wheels, Sphygmomanometer



PINARD  
01-008-150  
15 cm / 6"



1/2  
WARTENBERG  
01-009-180  
18 cm / 7"



1/2  
PROFESSIONAL  
01-010-190  
19 cm / 7 1/2"



ANEROID  
SPHYGMOMANOMETER  
01-011-000

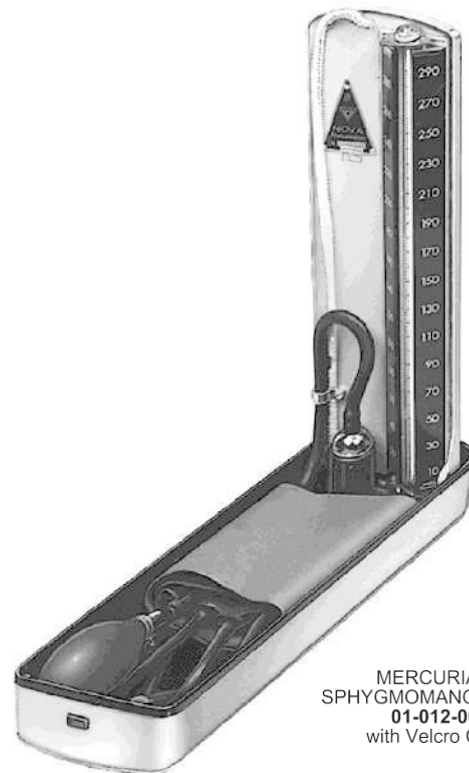

MERCURIAL  
SPHYGMOMANOMETER  
01-012-000  
with Velcro Cuff

Head Mirror, Calipers



ZIEGLER (COMPLETE)  
01-013-000

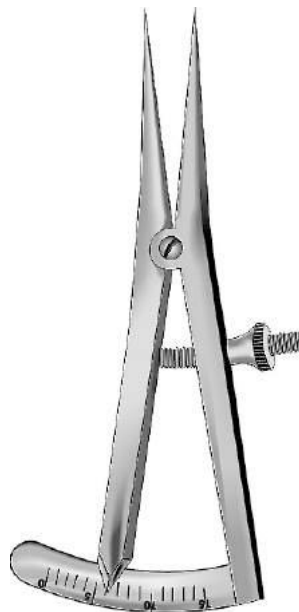

CASTROVIEJO  
01-014-085  
8.5 cm / 3 1/4"

Probes, Cotton Applicators

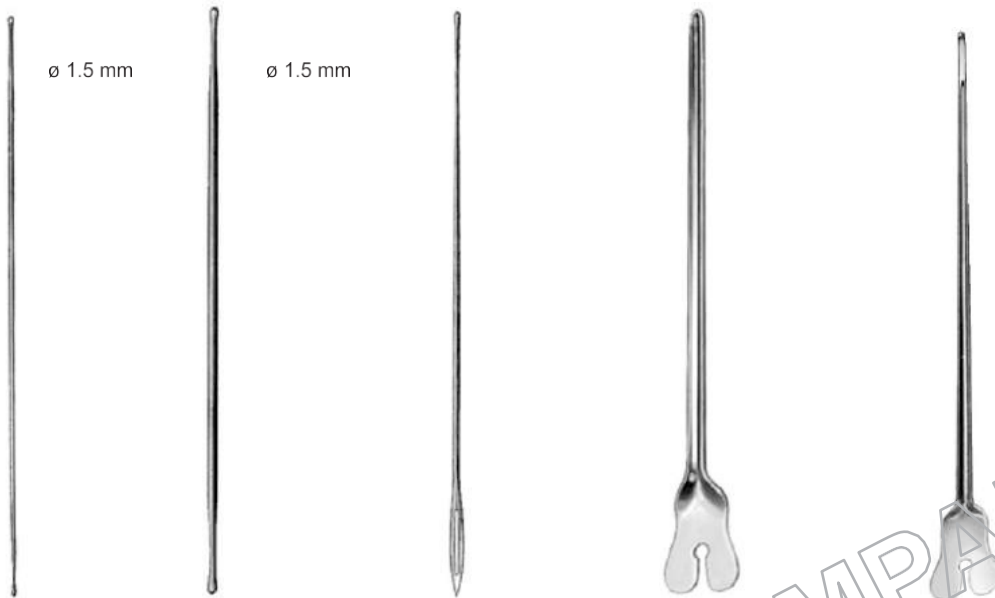

					NETATON
14.5cm / 5 1/2"	01-015-145	01-016-145	01-017-145	01-018-145	-
16 cm / 6 1/4"	01-015-160	01-016-160	01-017-160	01-018-160	01-019-160
18 cm / 7"	01-015-180	01-016-180	01-017-180	01-018-180	-
20 cm / 8"	01-015-120	01-016-120	01-017-120	01-018-120	-

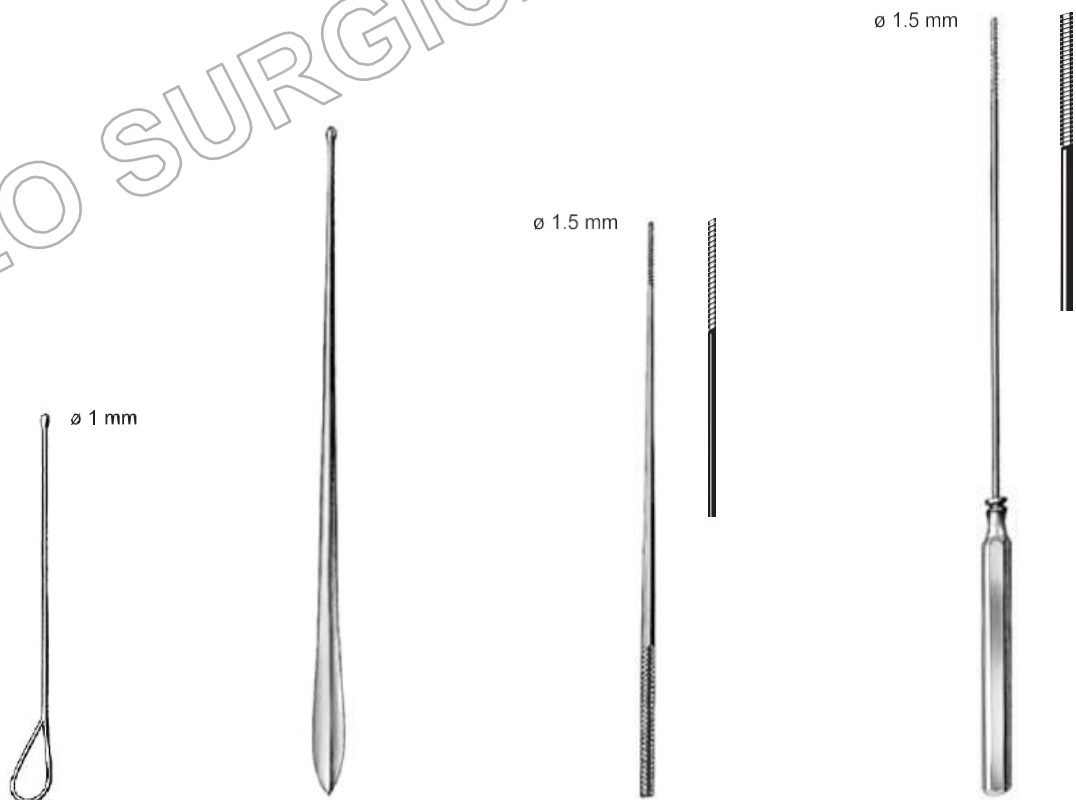

STACKE  
 01-020-105  
 10.5 cm / 4 1/4"

MARTYLE  
 01-021-145 – 14.5 cm / 5 1/2"  
 01-022-160 – 16 cm / 6 1/4"

FARREL (FROHN)  
 01-023-120 – 12 cm / 4 3/4", ø 0.9 mm  
 01-024-145 – 14.5 cm / 5 1/2", ø 0.9 mm  
 01-025-160 – 16 cm / 6 1/4", ø 1.1 mm

01-026-120 – 12 cm / 4 3/4"  
 01-027-140 – 14 cm / 5 1/2"  
 01-028-160 – 16 cm / 6 1/4"  
 01-029-180 – 18 cm / 7"

Trocars, Suction Tubes

6 mm



01-030-006

10 mm



01-030-010

6 mm



01-031-006

8 mm



01-031-008



POOLE  
 22 cm / 8 3/4"



POOLE  
 22 cm / 8 3/4"



YANKAUER  
 01-033-000



12.5 cm / 5" 18 cm / 7"  
 01-034-125 01-034-180



FRAZIER  
 12.5 cm / 5" 18 cm / 7"  
 01-035-125 01-036-180

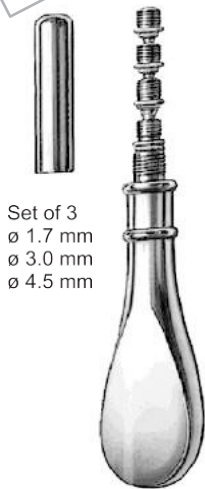

Set of 3  
 ø 1.7 mm  
 ø 3.0 mm  
 ø 4.5 mm

UNIVERSAL  
 01-032-000

LEO SURGICAL COMPANY

# SCISSOR

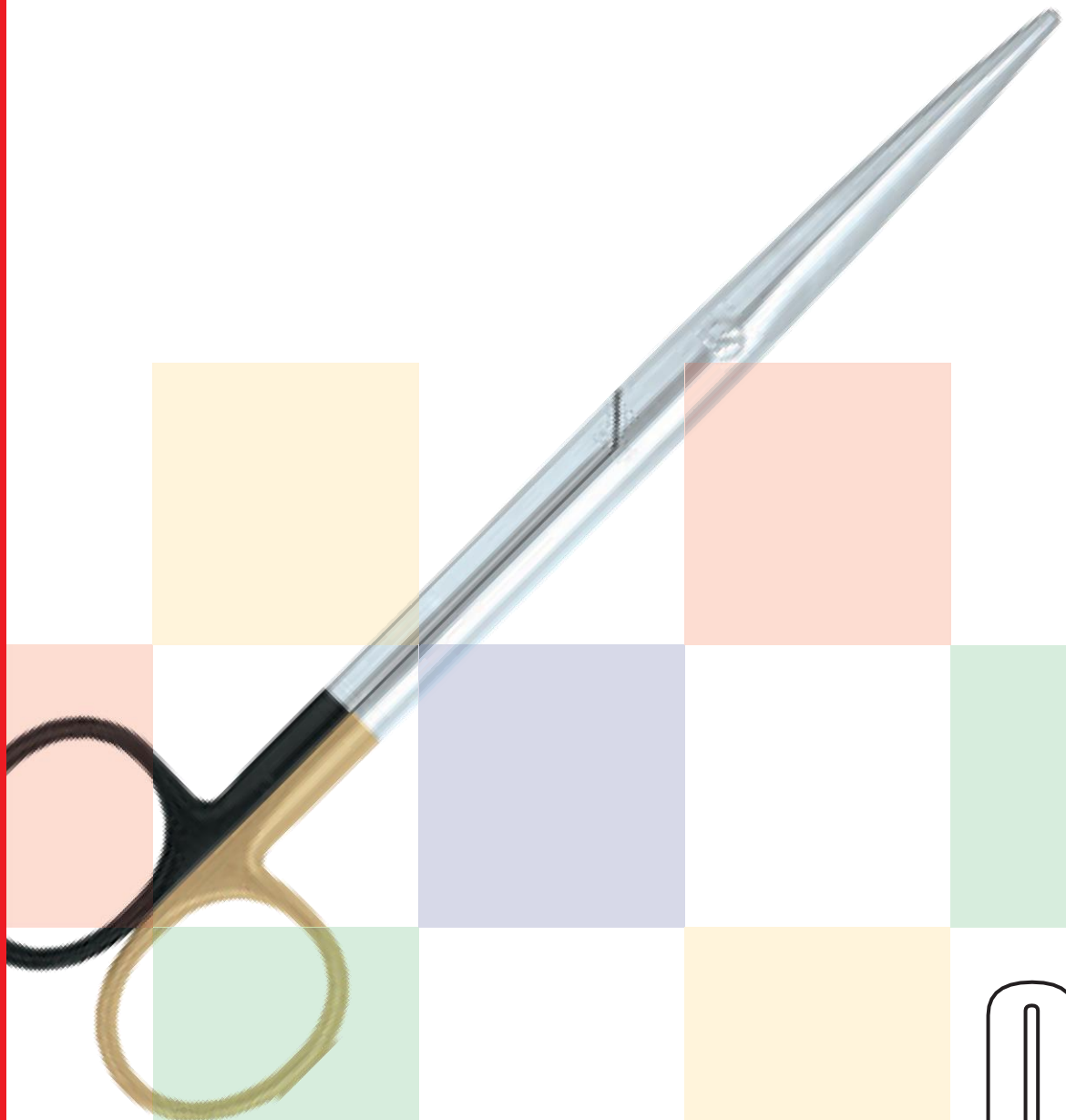

Iris Scissors, with Tungsten Carbide T/C Inserts

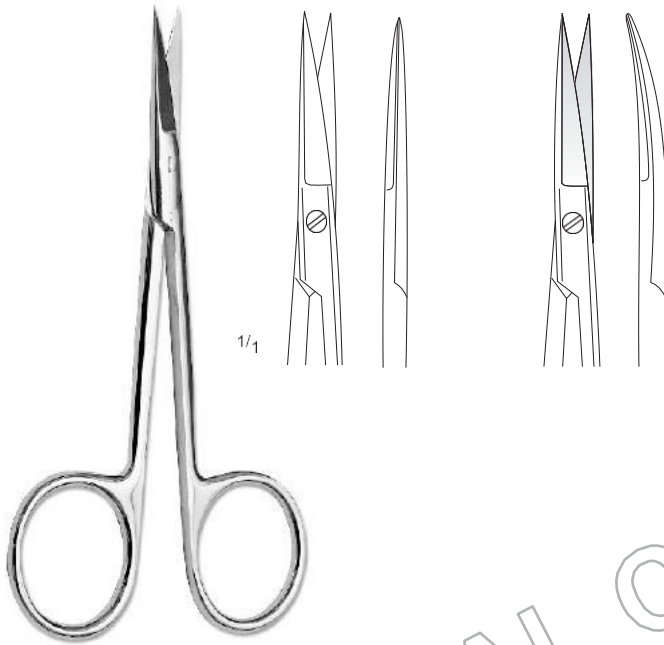

IRIS

Straight		Curved	
02-001-105	10.5 cm / 4 1/8"	02-002-105	
02-001-115	11.5 cm / 4 1/2"	02-003-115	

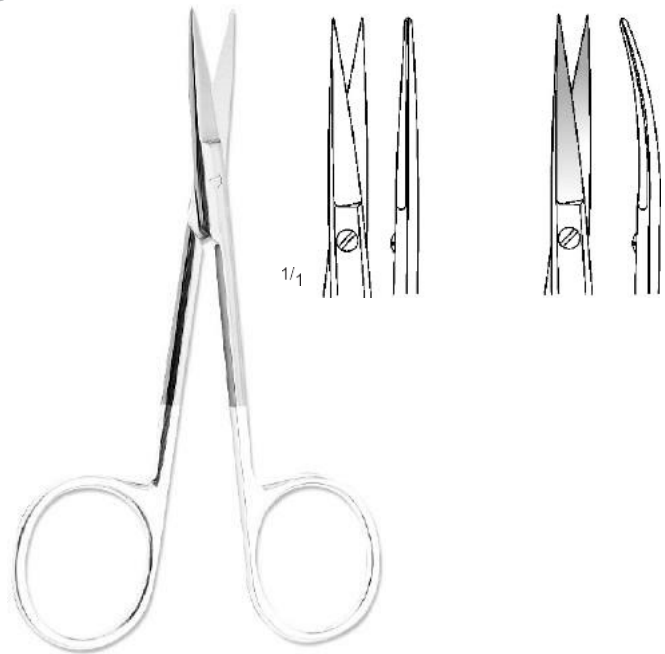

IRIS T/C

Straight		Curved	
02-004-115	11.5 cm / 4 1/2"	02-005-115	

LEO SURGICAL COMPANY



Delicate Scissors

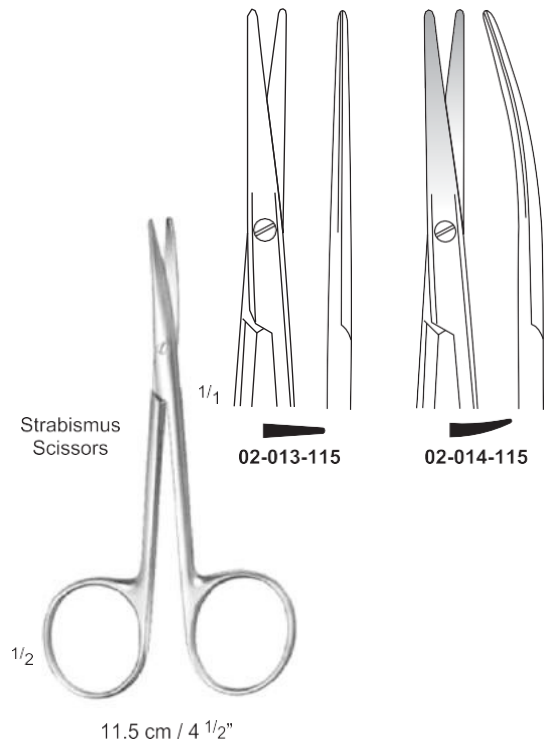
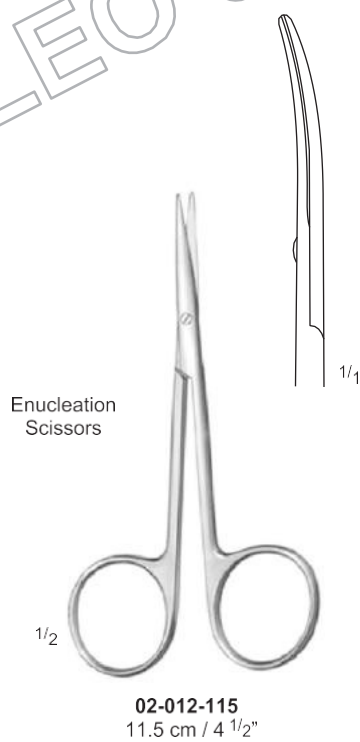
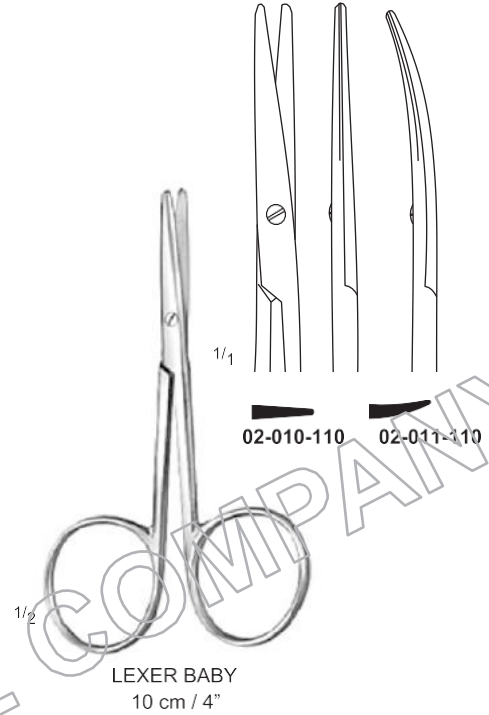
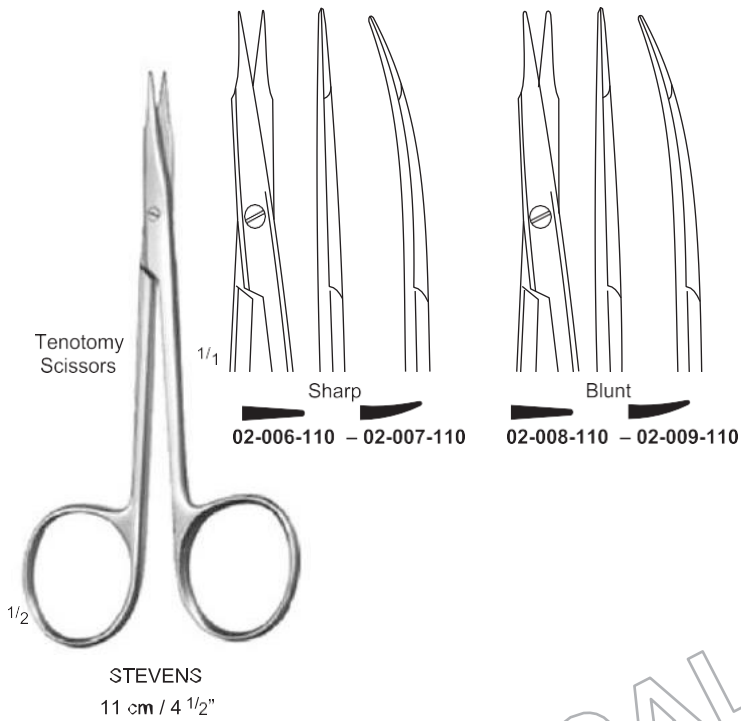

Operating Scissors

Blunt / Blunt

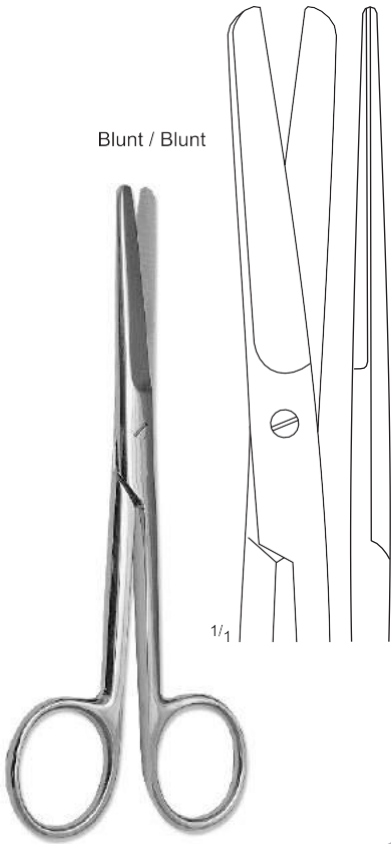

Sharp / Sharp



11.5 cm / 4 1/2"	02-014-115	02-015-115
13 cm / 5"	02-014-130	02-015-130
14.5 cm / 5 3/4"	02-014-145	02-015-145
15 cm / 6"	02-014-150	02-015-150
16.5 cm / 6 1/2"	02-014-165	02-015-165
18.5 cm / 7 1/4"	02-014-185	02-015-185

11.5 cm / 4 1/2"	02-016-115	02-017-115
13 cm / 5"	02-016-130	02-017-130
14.5 cm / 5 3/4"	02-016-145	02-017-145
15 cm / 6"	02-016-150	02-017-150
16.5 cm / 6 1/2"	02-016-165	02-017-165
18.5 cm / 7 1/4"	02-016-185	02-017-185

Sharp / Blunt

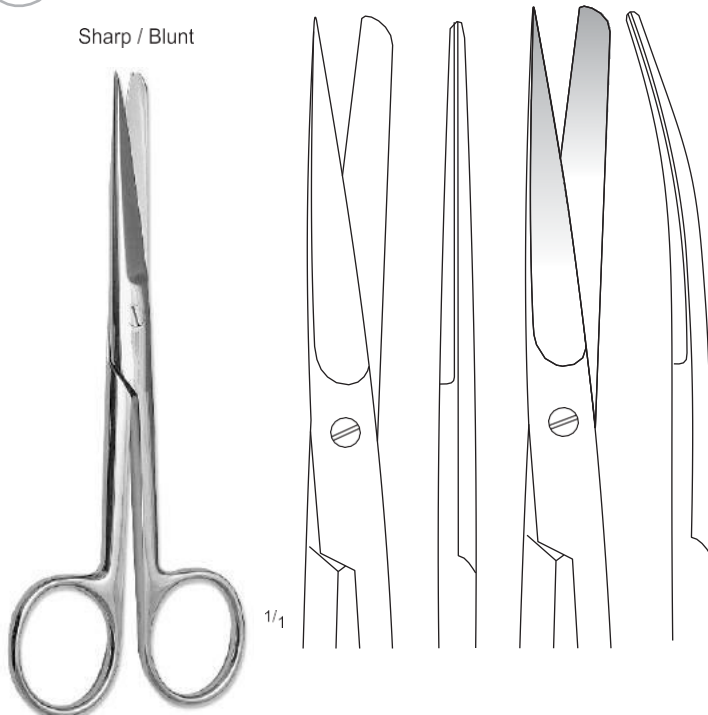



11.5 cm / 4 1/2"	02-018-115	02-019-115
13 cm / 5"	02-018-130	02-019-130
14.5 cm / 5 3/4"	02-018-145	02-019-145
15 cm / 6"	02-018-150	02-019-150
16.5 cm / 6 1/2"	02-018-165	02-019-165
18.5 cm / 7 1/4"	02-018-185	02-019-185

Dissecting Scissors, with Tungsten Carbide T/C Inserts

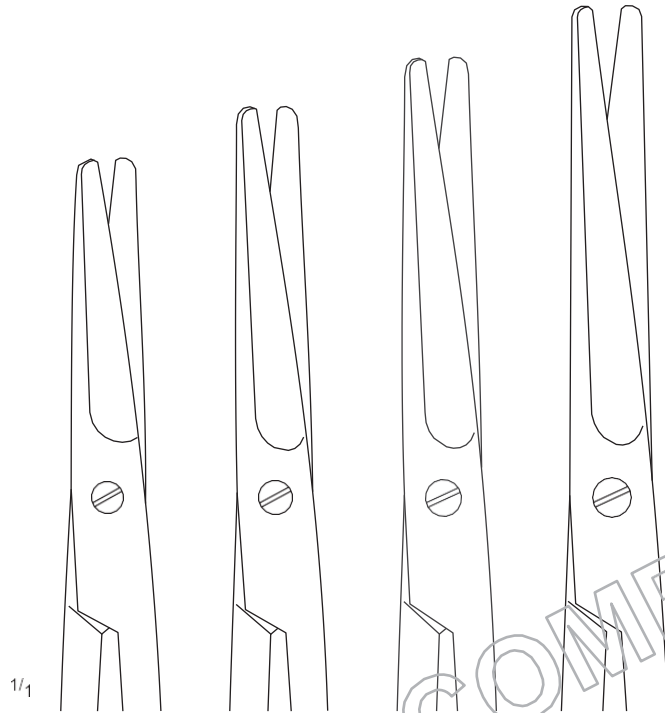

MAYO



Straight	<b>02-021-140</b>	<b>02-023-150</b>	<b>02-025-170</b>	<b>02-027-230</b>	
Curved	<b>02-022-140</b>	<b>02-024-150</b>	<b>02-026-170</b>	<b>02-028-230</b>	
	14 cm / 5 1/2"	15.5 cm / 6 1/8"	17 cm / 6 3/4"	23 cm / 9"	

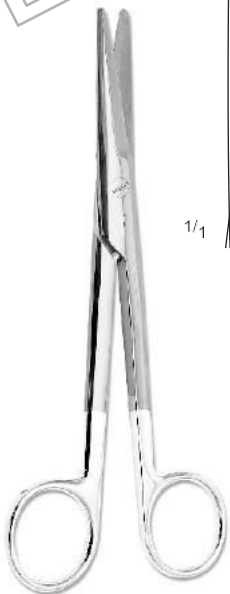

MAYO, T/C

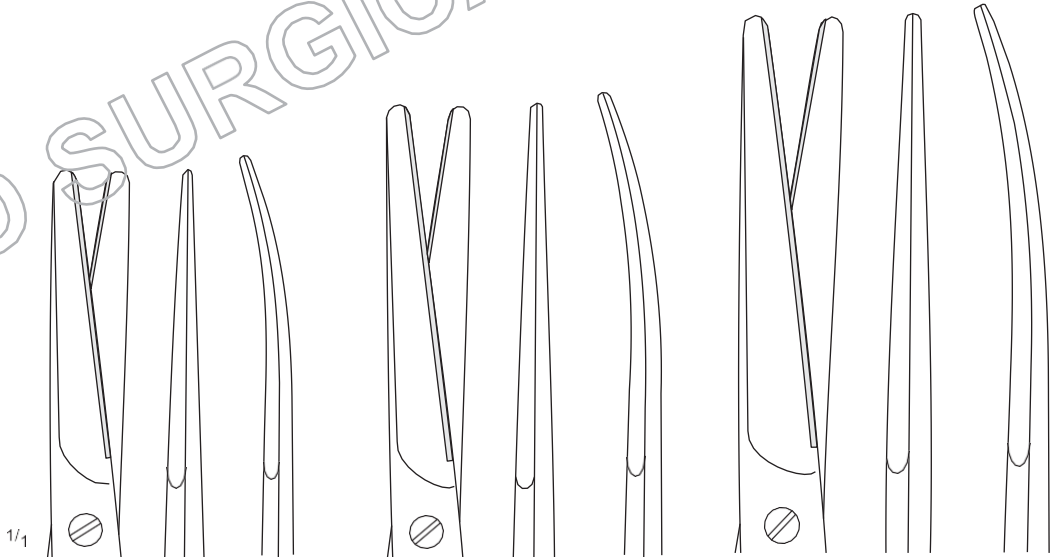

<b>02-029-140</b>	<b>02-030-140</b>	<b>02-031-155</b>	<b>02-032-155</b>	<b>02-033-170</b>	<b>02-034-170</b>
14 cm / 5 1/2"		15.5 cm / 6 1/8"		17 cm / 6 3/4"	

Operating Scissors with Tungsten Carbide T/C Inserts

Blunt / Blunt

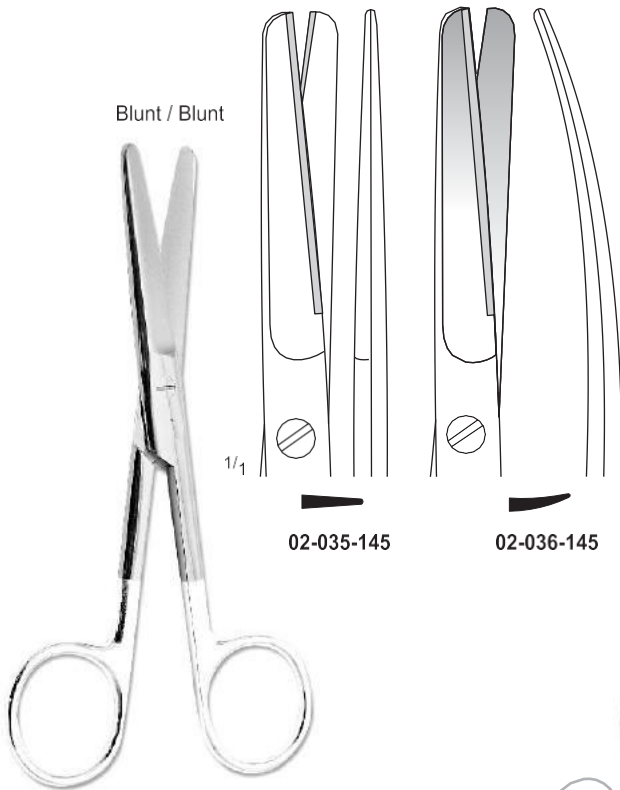

02-035-145

02-036-145

14.5 cm / 5 3/4"

Sharp / Sharp

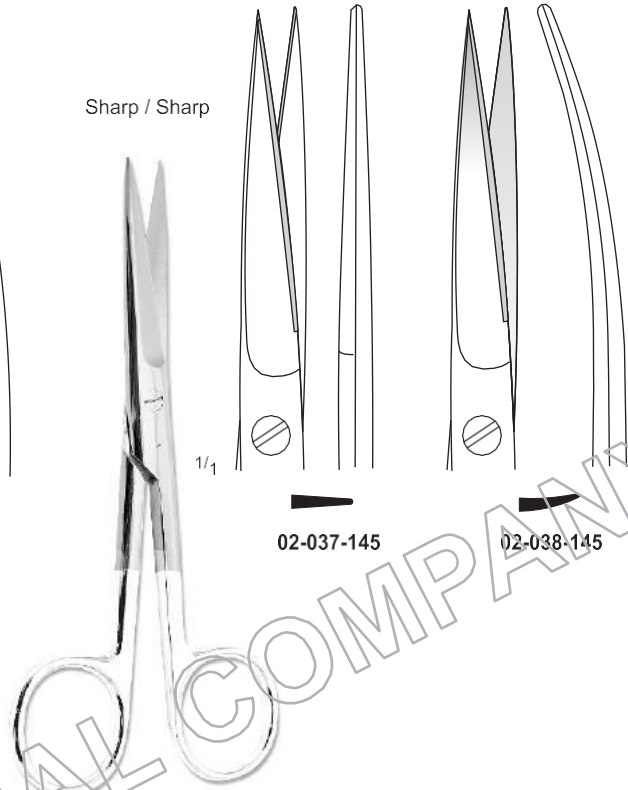

02-037-145

02-038-145

14.5 cm / 5 3/4"

Sharp / Blunt

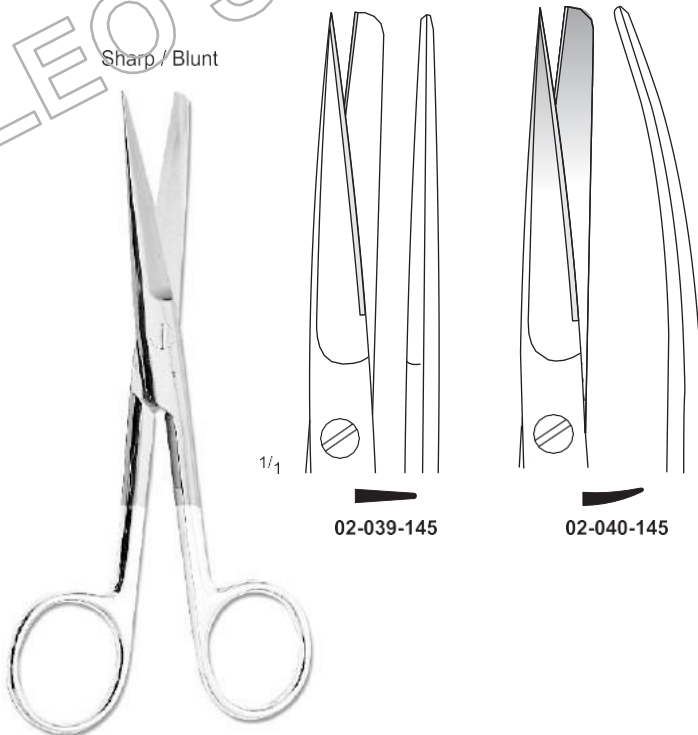

02-039-145

02-040-145

14.5 cm / 5 3/4"

Dissecting Scissors, with Tungsten Carbide T/C Inserts



MAYO-STILLE

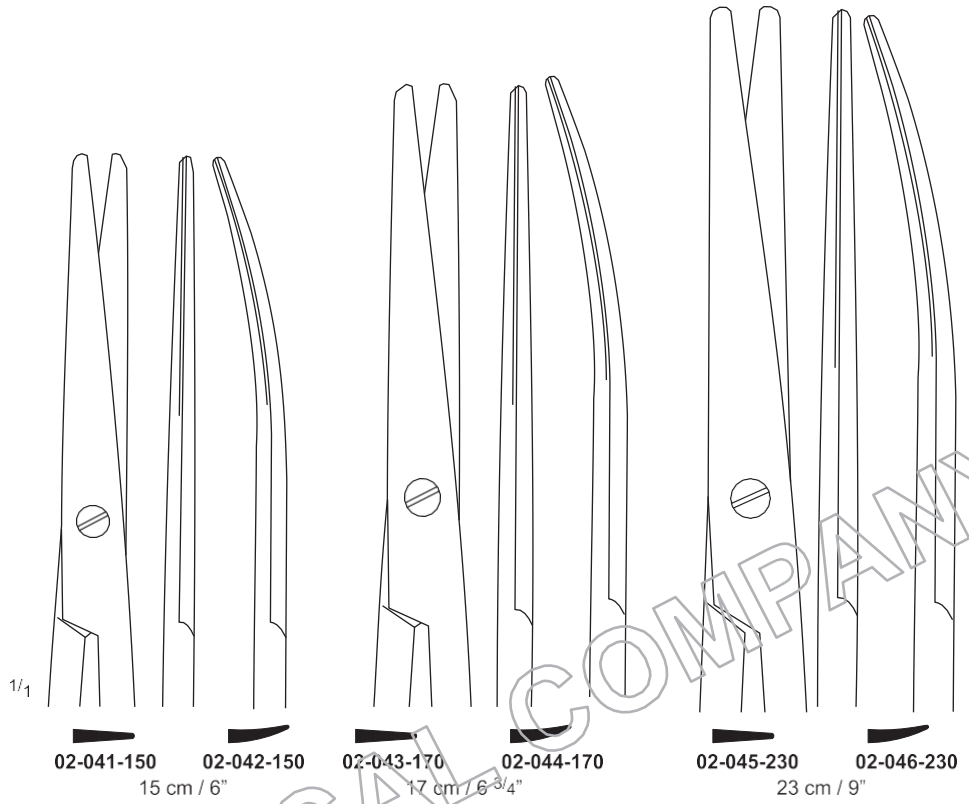

MAYO-STILLE T/C

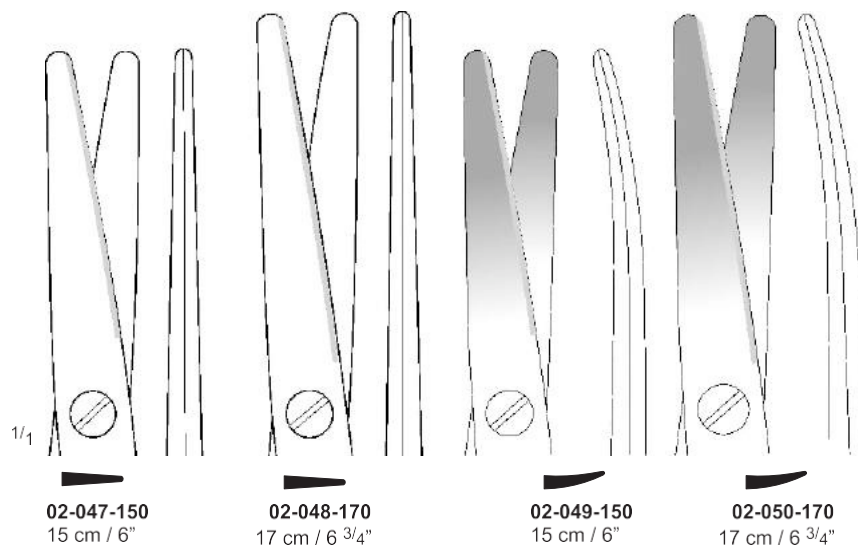

Abdominal Scissors, Uterine Scissors, with Tungsten Carbide T/C Inserts



DOYEN  
18 cm / 7 1/8"

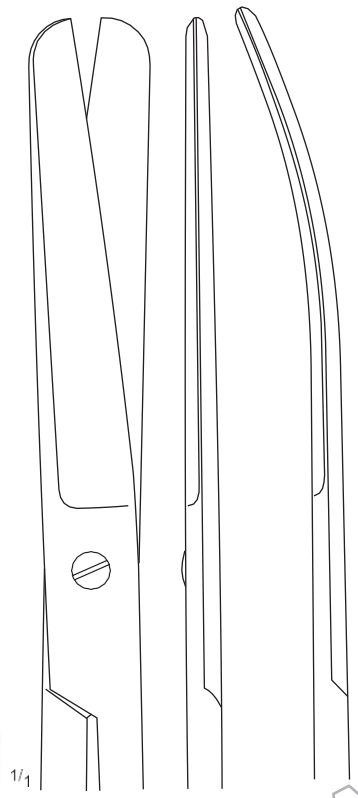

02-051-180

02-052-180

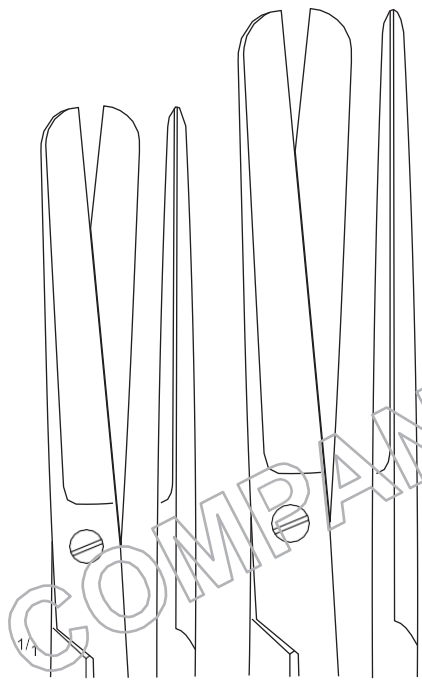

02-053-200  
20 cm / 8"

02-054-230  
23 cm / 9"

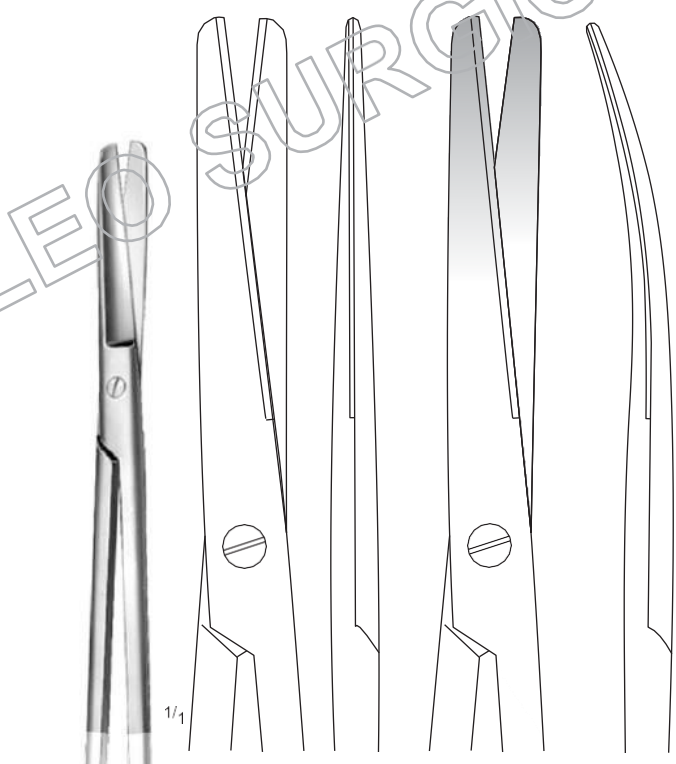

02-055-230

02-056-230

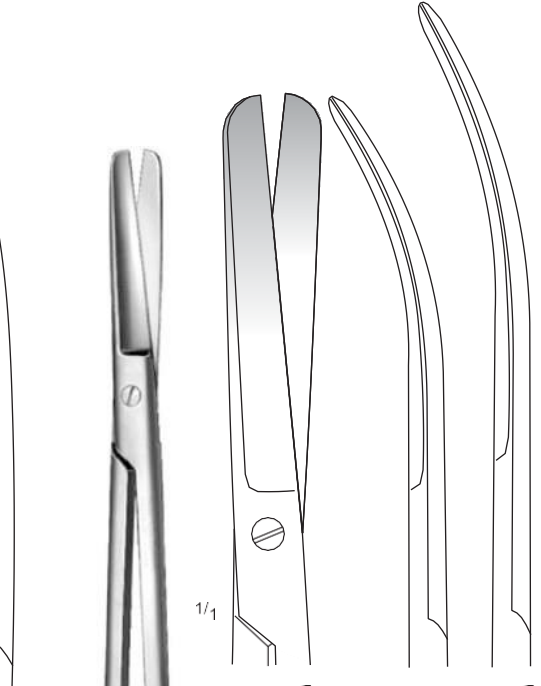

02-057-200  
20 cm / 8"

02-058-230  
23 cm / 9"

SIMS

1/2  
SIMS "TC"  
23 cm / 9"

Dissecting Scissors, Incision Scissors

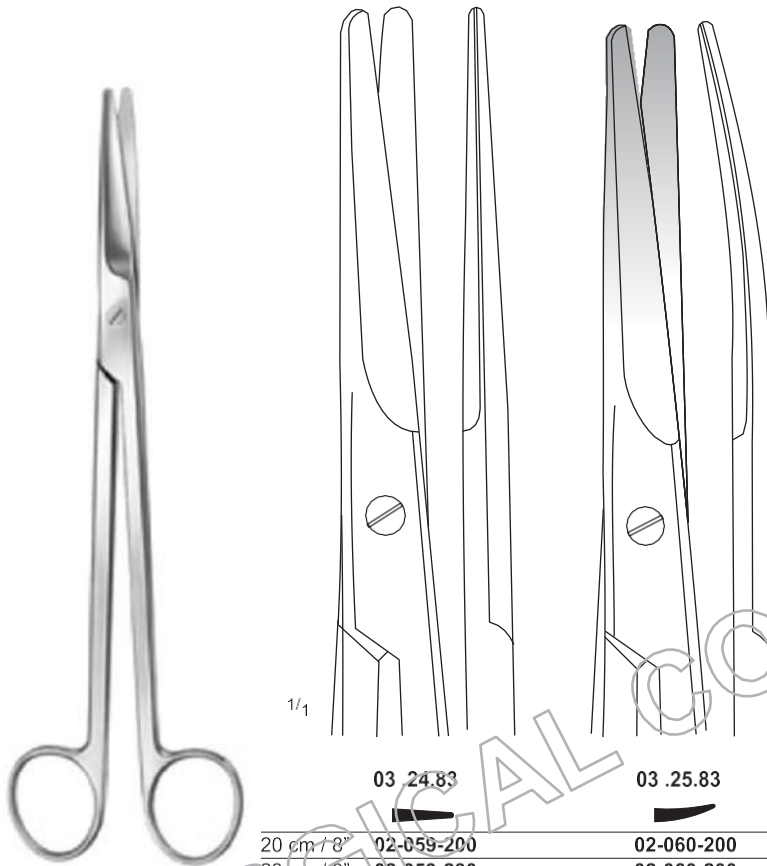

MAYO-HARRINGTON  
03 .24-80 – 03 .25.83

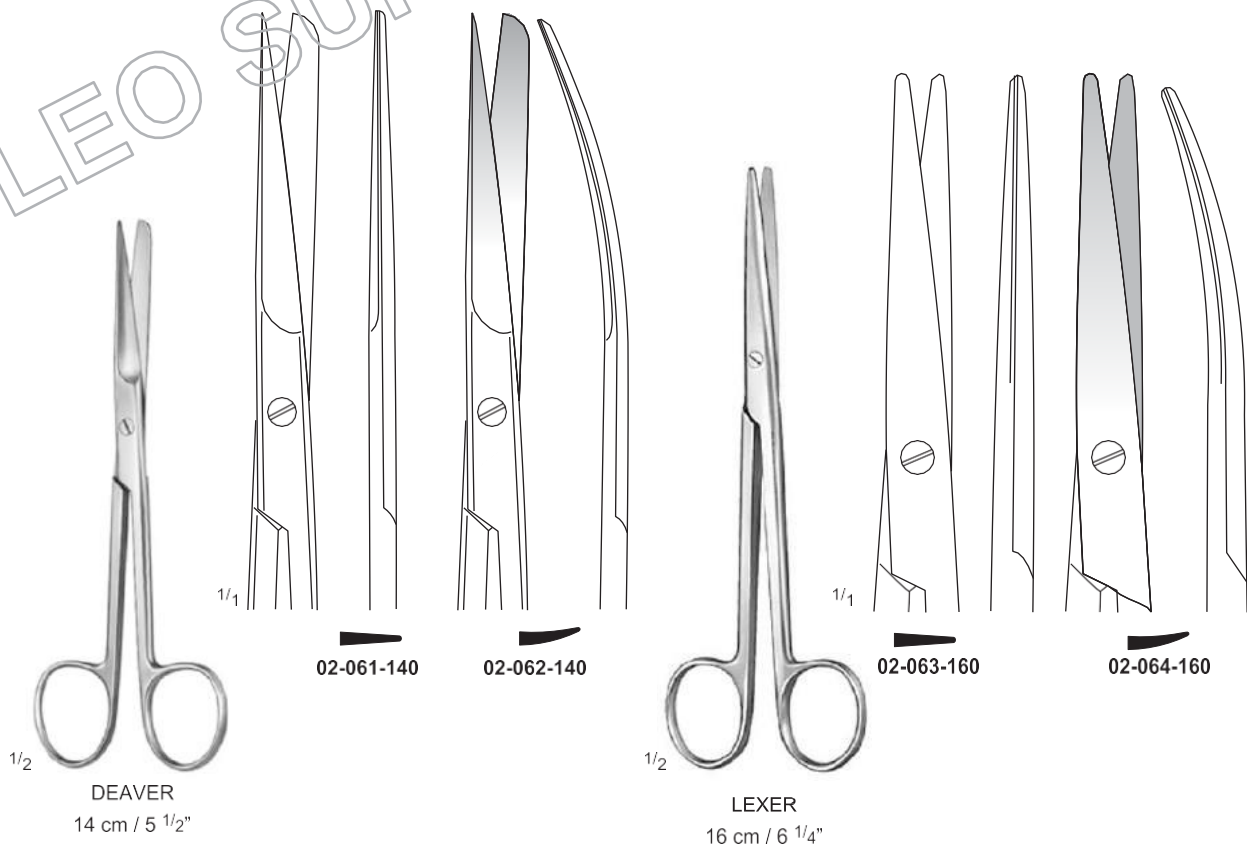

DEAVER  
14 cm / 5 1/2"

LEXER  
16 cm / 6 1/4"

Dissecting Scissors

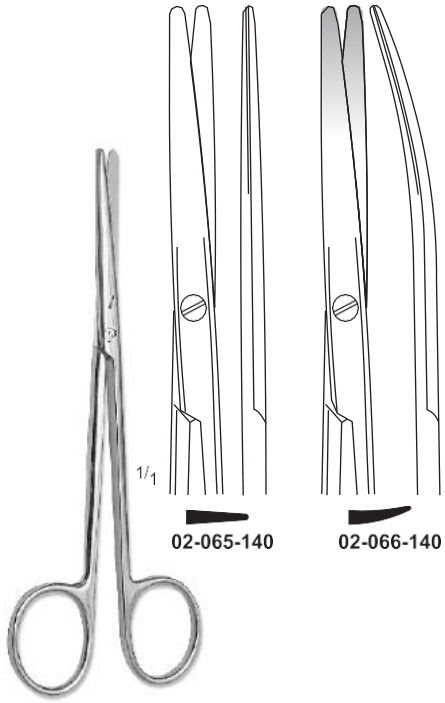

02-065-140

02-066-140

METZENBAUM

14 cm / 5 1/2"

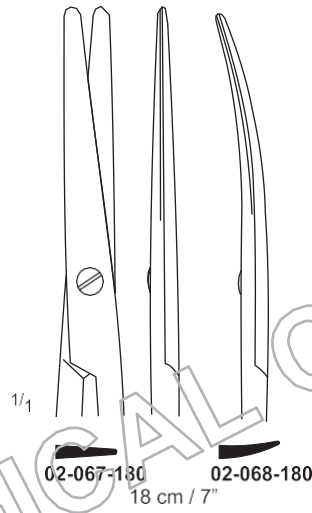

02-067-180

02-068-180

18 cm / 7"

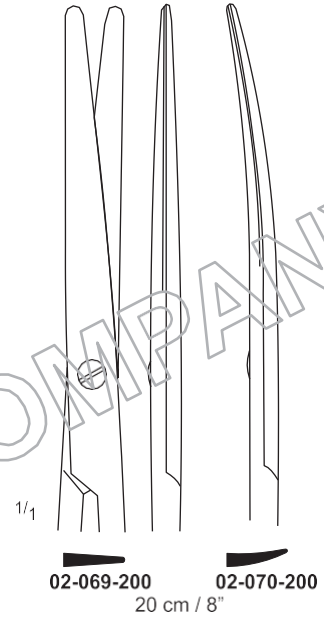

02-069-200

02-070-200

20 cm / 8"

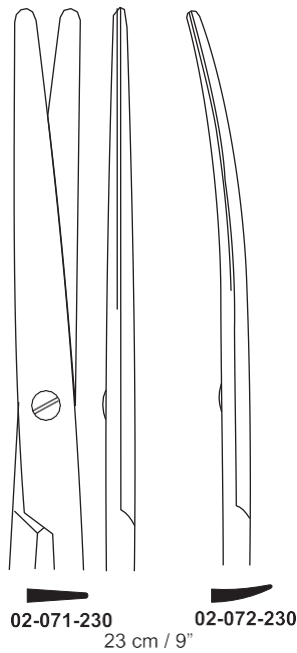

02-071-230

02-072-230

23 cm / 9"

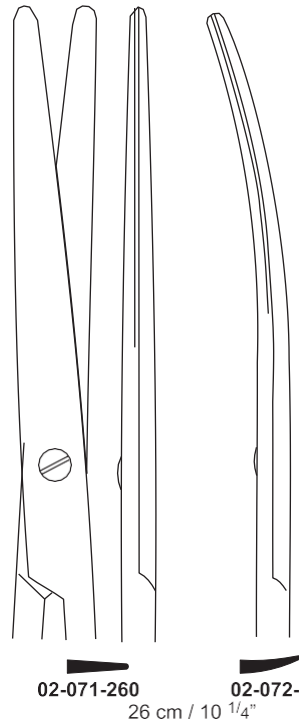

02-071-260

02-072-260

26 cm / 10 1/4"

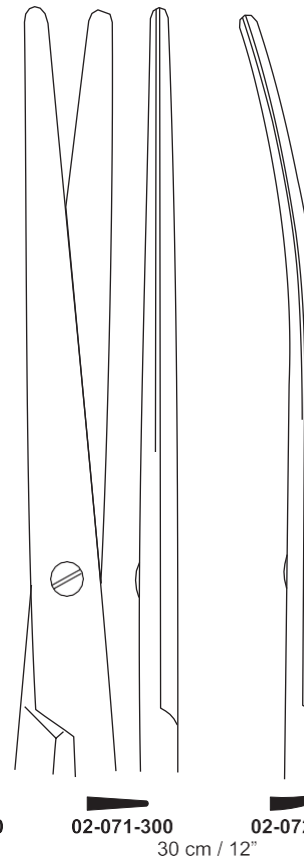

02-071-300

02-072-300

30 cm / 12"

METZENBAUM (NELSON)



Dissecting Scissors with Tungsten Carbide T/C Inserts

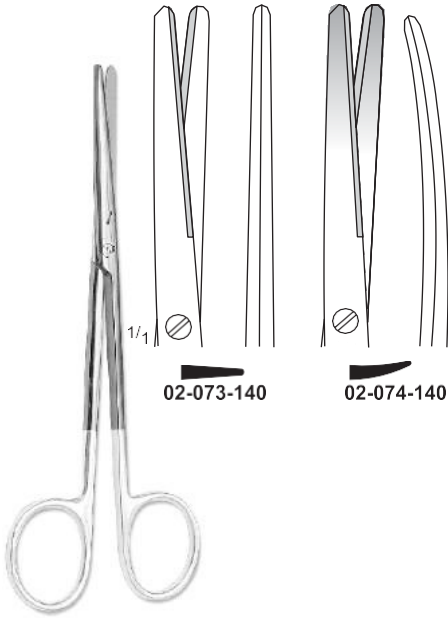

METZENBAUM, T/C  
14 cm / 5 1/2"

02-073-140

02-074-140

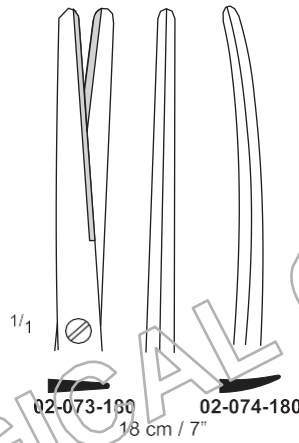

1/1

02-073-180

02-074-180

18 cm / 7"

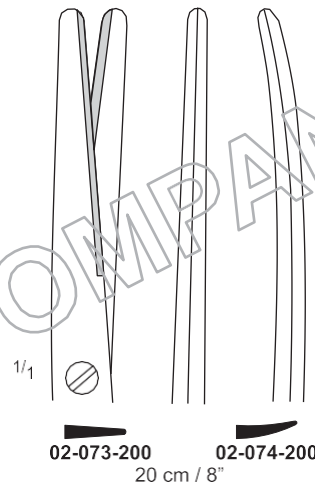

1/1

02-073-200

02-074-200

20 cm / 8"



METZENBAUM T/C  
METZENBAUM (NELSON) T/C

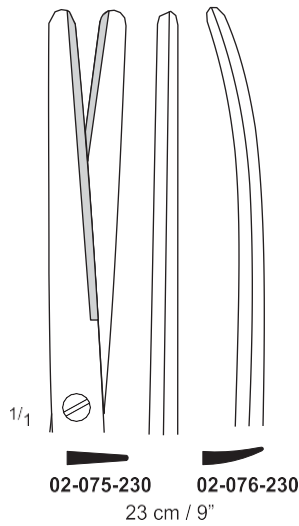

1/1

02-075-230

02-076-230

23 cm / 9"

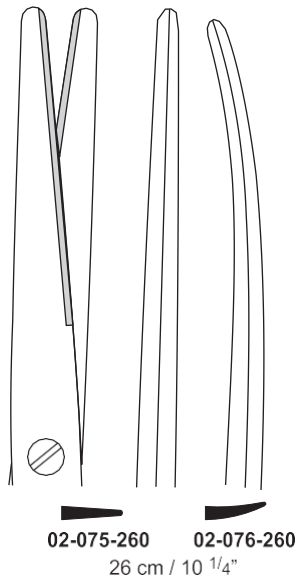

02-075-260

02-076-260

26 cm / 10 1/4"

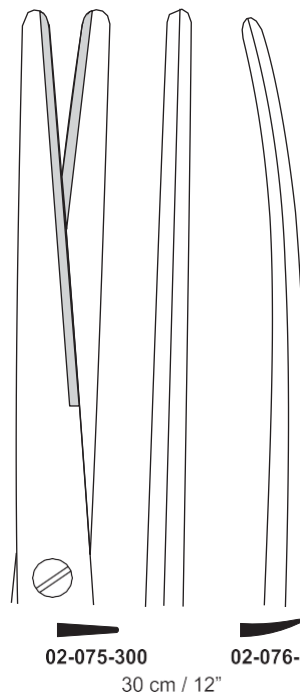

02-075-300

02-076-300

30 cm / 12"

Fine Dissecting Scissors, with Tungsten Carbide T/C Inserts

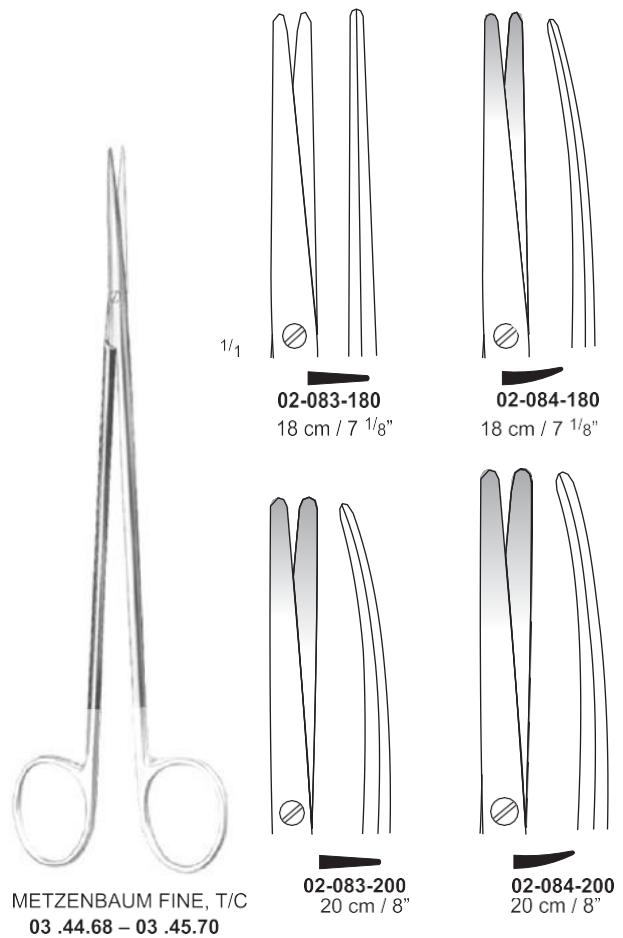
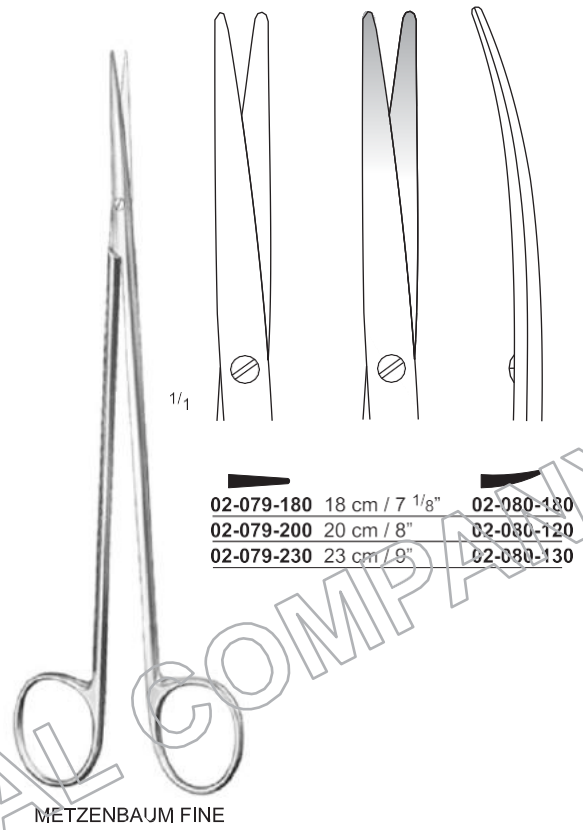
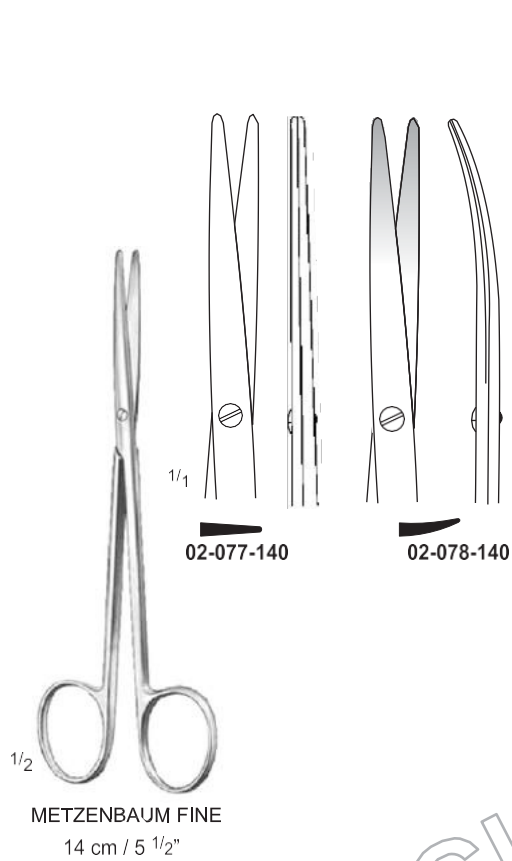

Dissecting Scissors, with Tungsten Carbide T/C Inserts

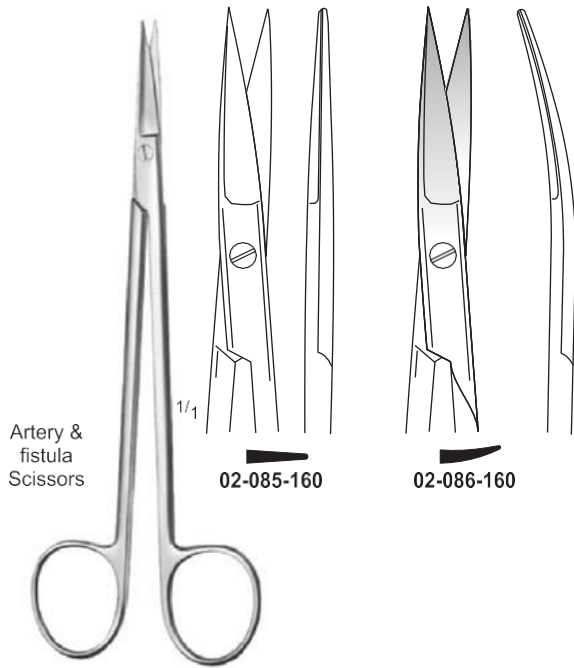

Artery & fistula Scissors

1/1

02-085-160

02-086-160

1/1

02-087-160

02-088-160

KELLY  
16 cm / 6 1/4"

KELLY, T/C  
16 cm / 6 1/4"

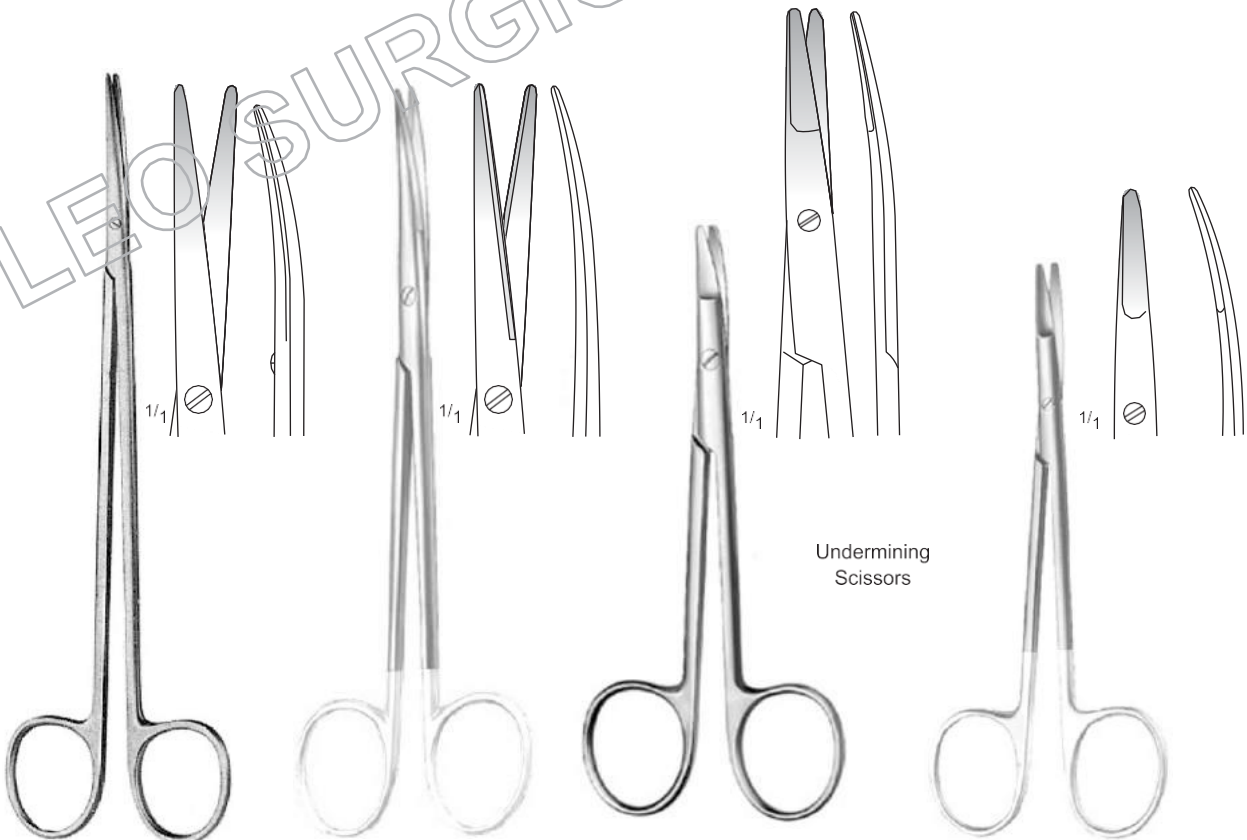

Undermining Scissors

1/1

1/1

1/1

1/1

TOENNIS ADSON  
02-089-180  
18 cm / 7 1/8"

TOENNIS ADSON, T/C  
02-090-180  
18 cm / 7 1/8"

KILNER  
02-091-130 - 13 cm / 5 1/8"  
02-091-150 - 15 cm / 6"

KILNER, T/C  
02-092-130  
13 cm / 5 1/8"

Fine Operating Scissors, Plastic Surgery Scissors



<sup>1/2</sup>  
JOSEPH  
14 cm / 5 1/2"

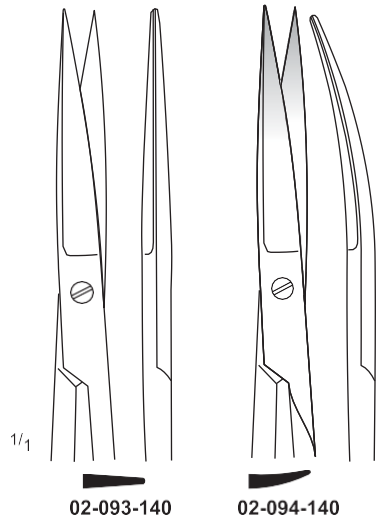

02-093-140      02-094-140

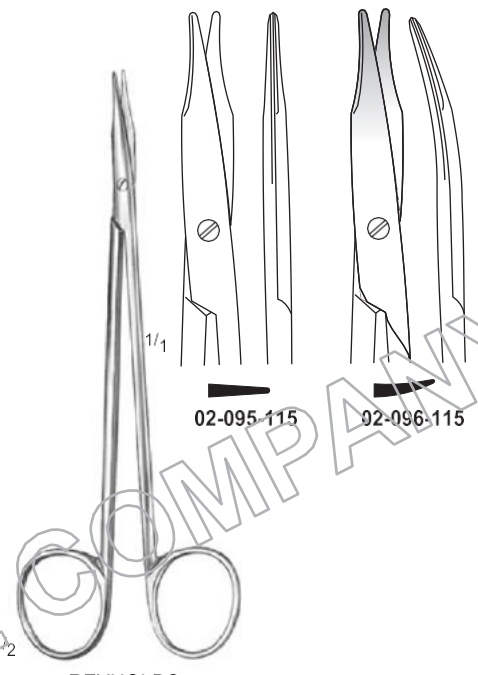

<sup>1/2</sup>  
REYNOLDS  
15 cm / 6"



02-095-115      02-096-115

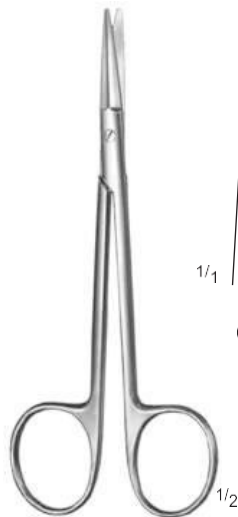

<sup>1/2</sup>  
GORNEY

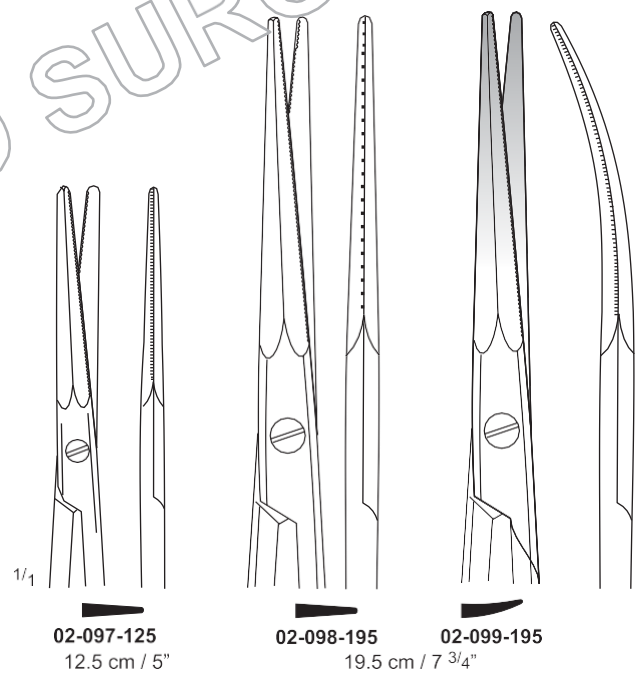

02-097-125      02-098-195      02-099-195  
12.5 cm / 5"      19.5 cm / 7 3/4"

Dissecting Scissors for Plastic Surgery  
Blades are outside semisharp  
and inside serrated.

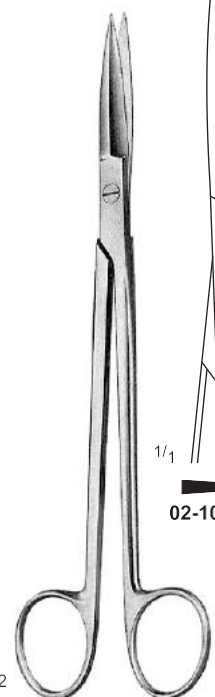

<sup>1/2</sup>  
MCINDOE  
18 cm / 7"  
Blades are outside sharp

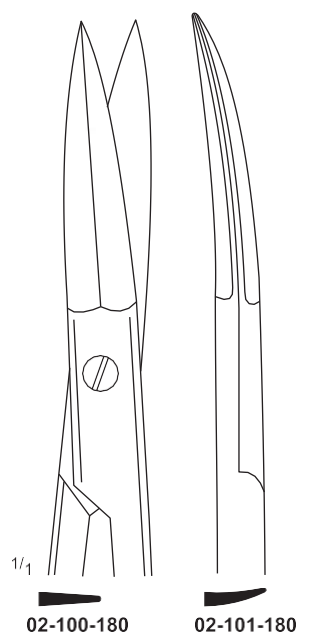

02-100-180      02-101-180

# SCALPEL & KNIVES



Scalpel Handles



STANDARD  
03-001-003  
No. 03

03-002-007  
No. 07

03-003-007  
No. 7K

03-004-003  
No. 3L

03-005-004  
No. 4

03-006-004  
No. 4L

Dissecting Knives



**Amputating and Brain Knives**



1/2

**LISTON**

**03-017-190**

Total Length	29 cm / 11 1/2"
Cutting Length	19 cm / 7 1/2"



1/2

**LANGENBECK**

**03-018-180**

Total Length	18 cm / 7"
Cutting Length	5.5 cm / 2 1/4"



1/2

**03-019-180**

Total Length	18 cm / 7"
Cutting Length	5.5 cm / 2 1/4"



**VIRCHOW**

**03-020-160** – 16 cm / 6 1/4"

**03-021-200** – 20 cm / 8"

**03-022-240** – 24 cm / 9 1/2"



# DRESSING & TISSUE FORCEPS

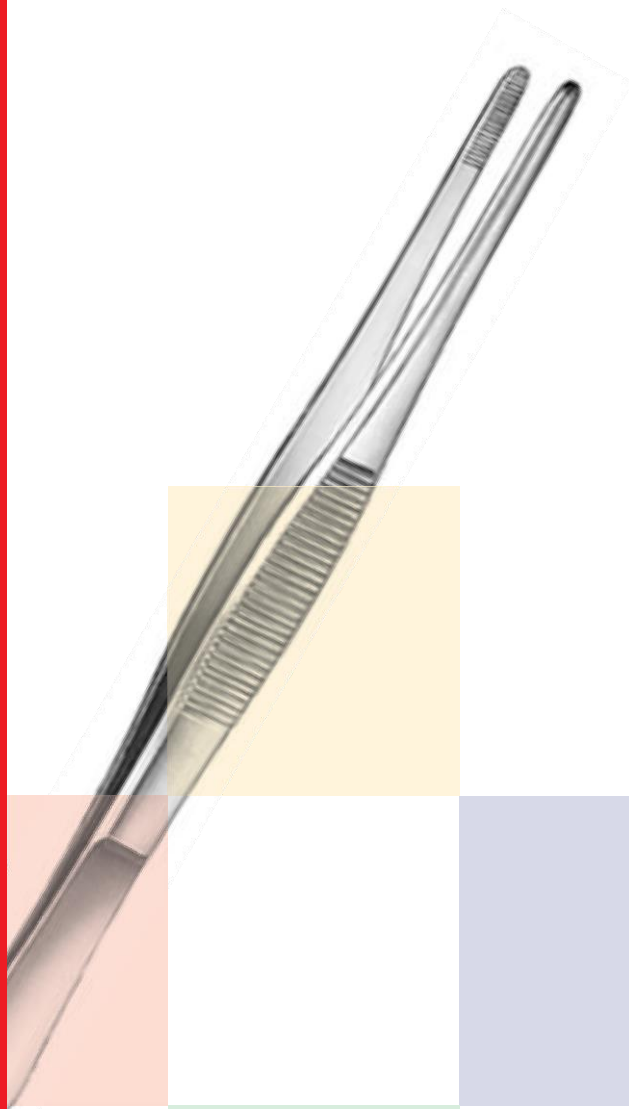

Dressing Forceps

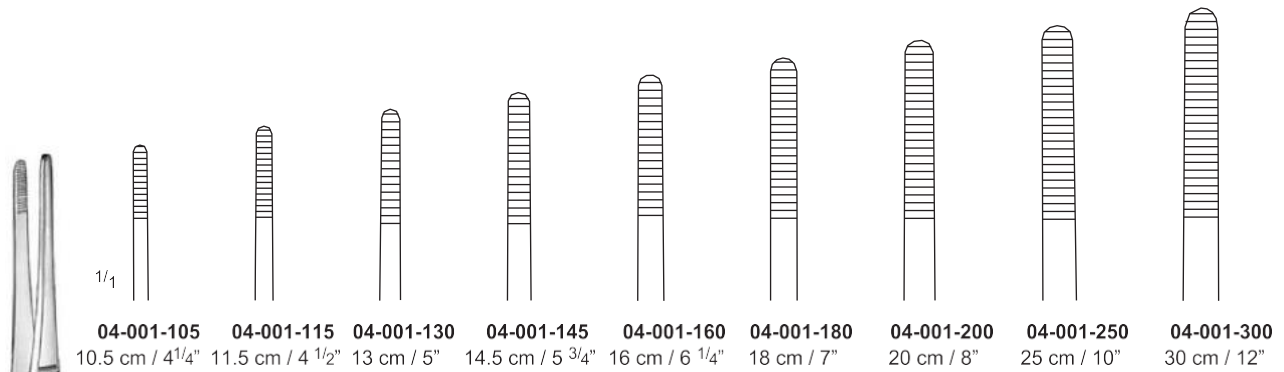

STANDARD

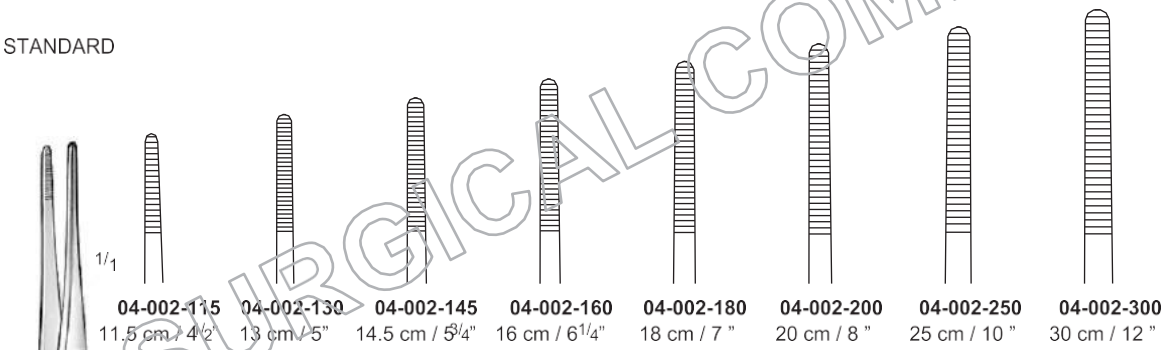

STANDARD  
 Narrow

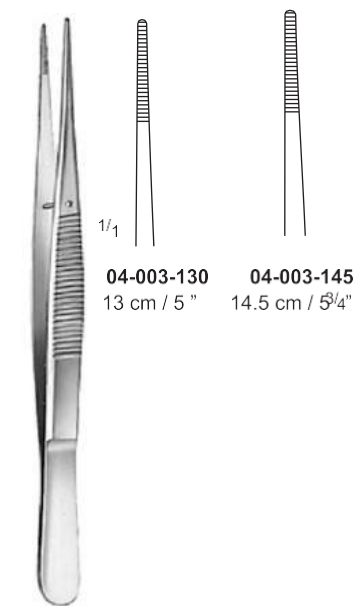

STANDARD  
 Delicate

Tissue Forceps

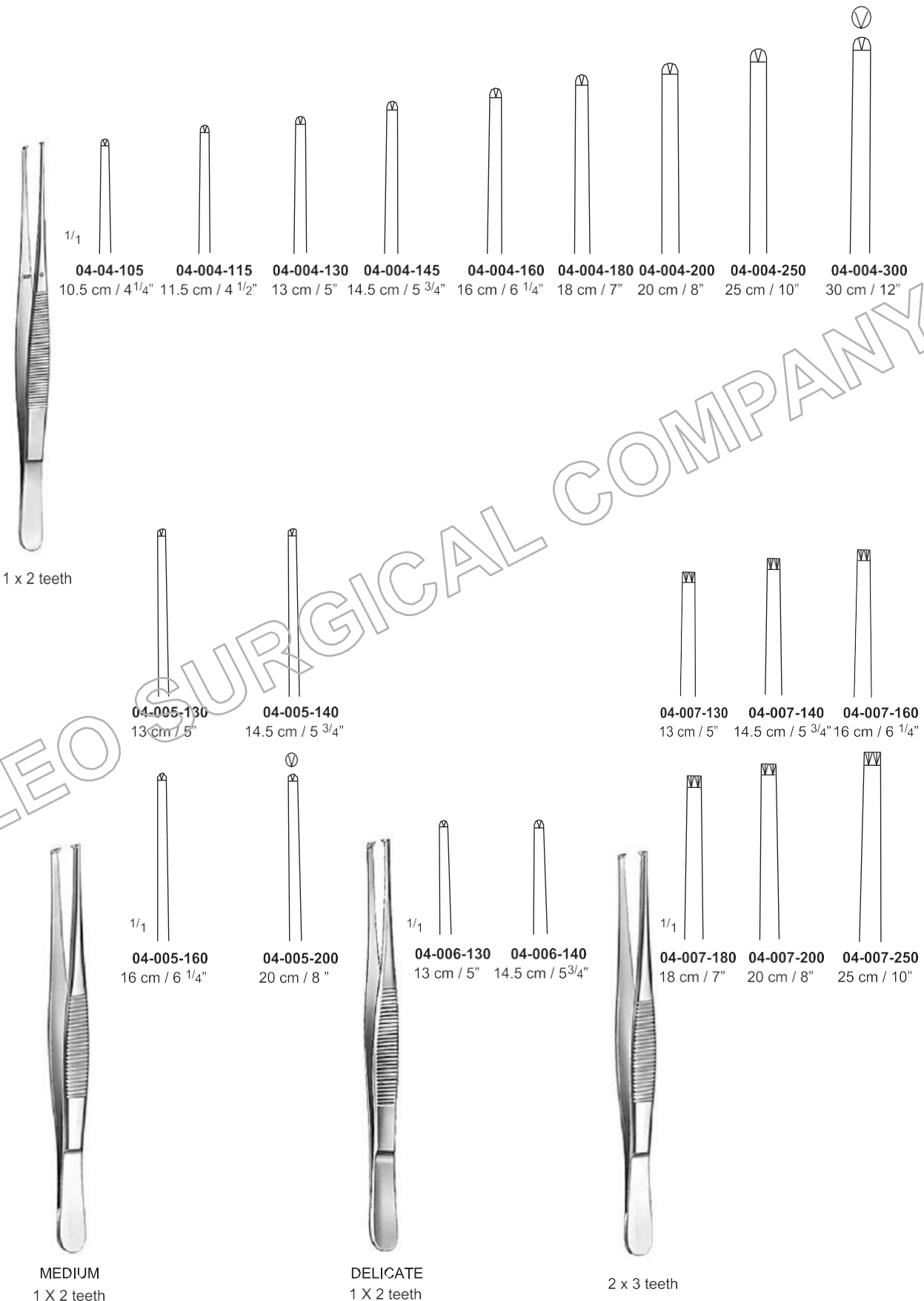

Part Number	Dimensions (cm / inches)
04-04-105	10.5 cm / 4 1/4"
04-004-115	11.5 cm / 4 1/2"
04-004-130	13 cm / 5"
04-004-145	14.5 cm / 5 3/4"
04-004-160	16 cm / 6 1/4"
04-004-180	18 cm / 7"
04-004-200	20 cm / 8"
04-004-250	25 cm / 10"
04-004-300	30 cm / 12"
04-005-130	13 cm / 5"
04-005-140	14.5 cm / 5 3/4"
04-007-130	13 cm / 5"
04-007-140	14.5 cm / 5 3/4"
04-007-160	16 cm / 6 1/4"
04-005-160	16 cm / 6 1/4"
04-005-200	20 cm / 8"
04-006-130	13 cm / 5"
04-006-140	14.5 cm / 5 3/4"
04-007-180	18 cm / 7"
04-007-200	20 cm / 8"
04-007-250	25 cm / 10"

1 x 2 teeth

MEDIUM  
1 X 2 teeth

DELICATE  
1 X 2 teeth

2 x 3 teeth

Tissue Forceps



3 x 4 teeth



04-008-140  
 14.5 cm / 5 3/4"



04-008-160  
 16 cm / 6 1/4"



4 x 5 teeth



04-009-130  
 13 cm / 5"



04-010-160  
 16 cm / 6 1/4"



LERCHE  
 04-011-150  
 15 cm / 6"  
 5 X 6 teeth

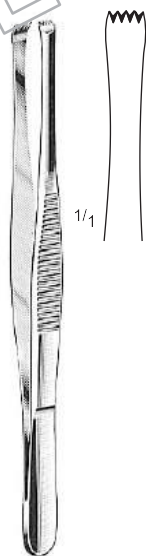

STONE  
 04-011-150  
 15 cm / 6"  
 5 x 6 teeth



ALDERKRUETZ



04-012-150  
 15 cm / 6"  
 2 x 3 teeth



04-013-200  
 20 cm / 8"  
 2 x 3 teeth



04-014-150  
 15 cm / 6"  
 4 x 5 teeth



04-015-200  
 20 cm / 8"  
 4 x 5 teeth

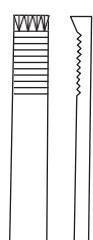

04-016-250  
 25 cm / 10"  
 4 x 5 teeth

LEO SURGICAL COMPANY

Adson Forceps, with Tungsten Carbide T/C Inserts

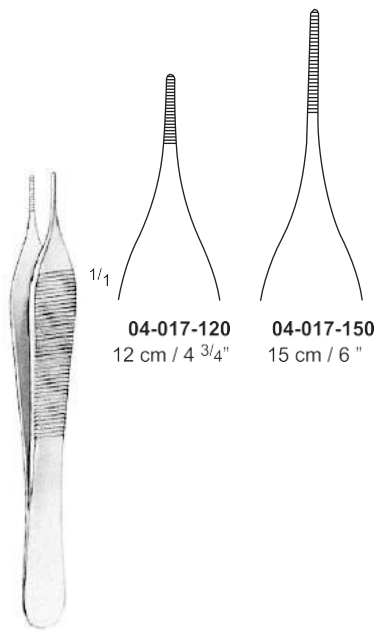

ADSON

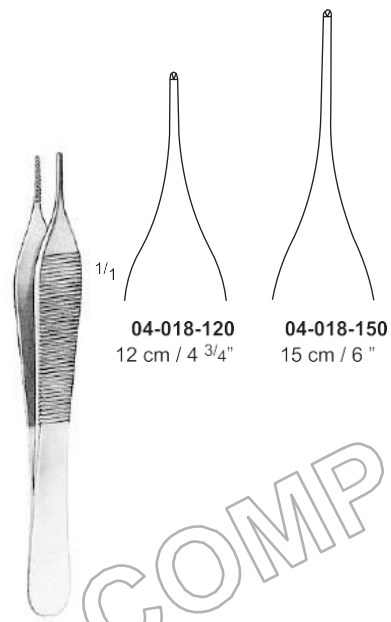

ADSON  
1 x 2 teeth

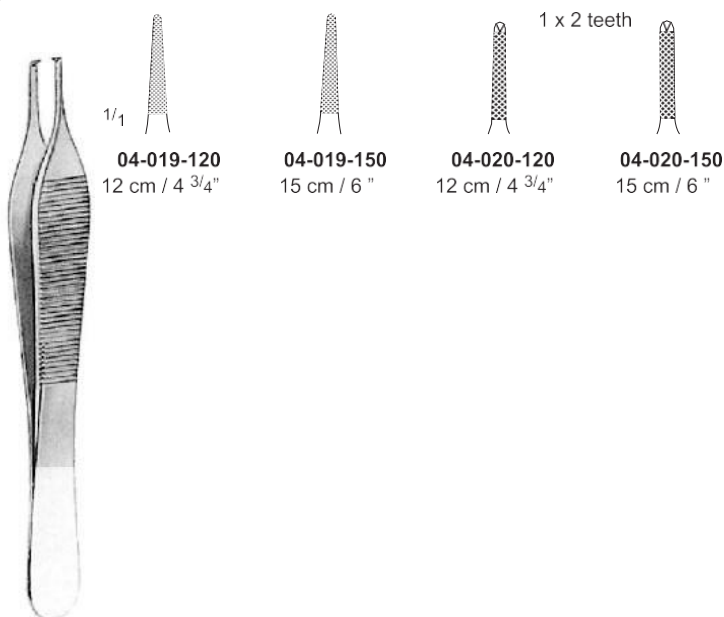

ADSON T/C

LEO SURGICAL COMPANY

Micro Tissue Forceps, with Tungsten Carbide T/C Inserts

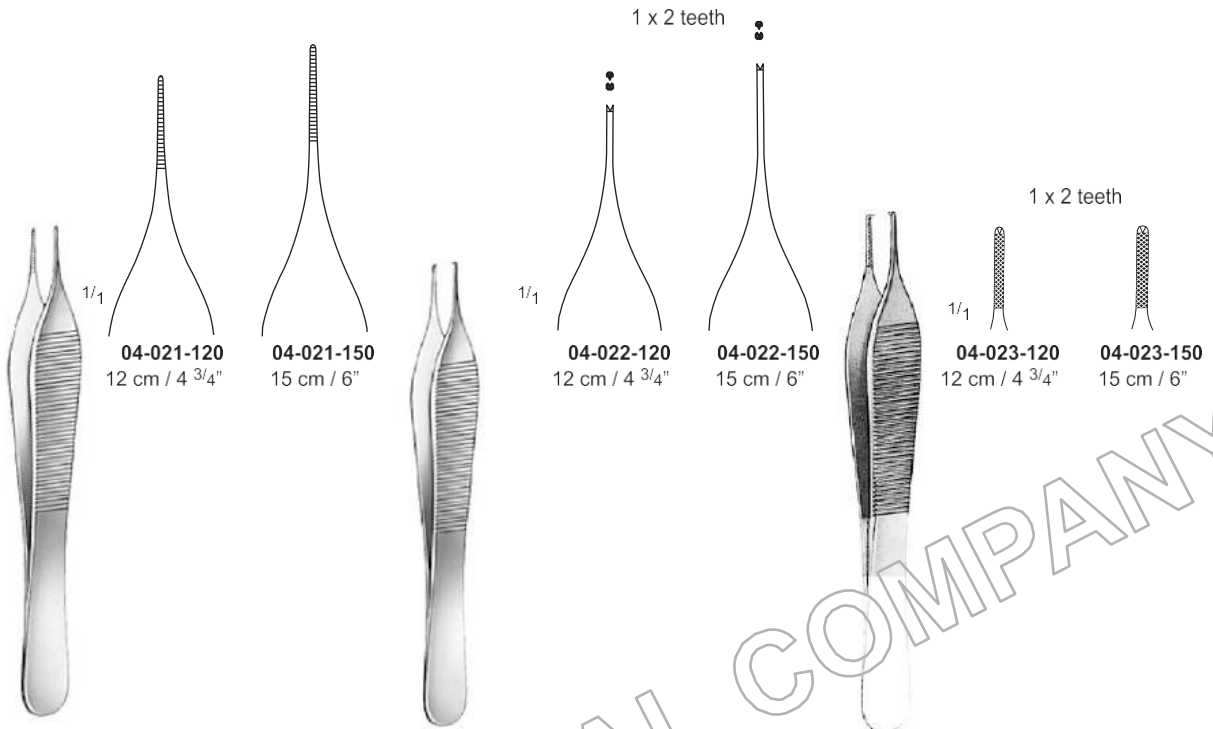

MICRO ADSON

MICRO ADSON

MICRO ADSON T/C

LEO SURGICAL COMPANY

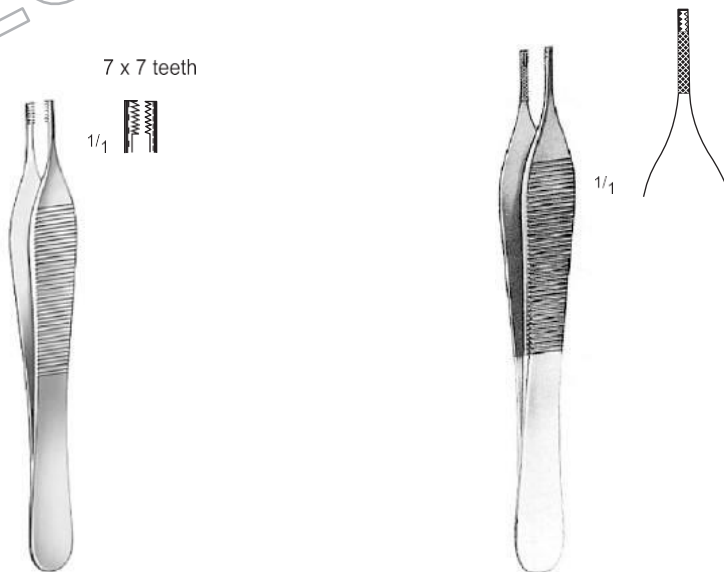

ADSON BROWN  
 04-024-120  
 12 cm / 4 3/4"

ADSON BROWN T/C  
 04-025-120  
 12 cm / 4 3/4"

**Delicate Tissue Forceps, with Tungsten Carbide T/C Inserts**



LEO SURGICAL COMPANY

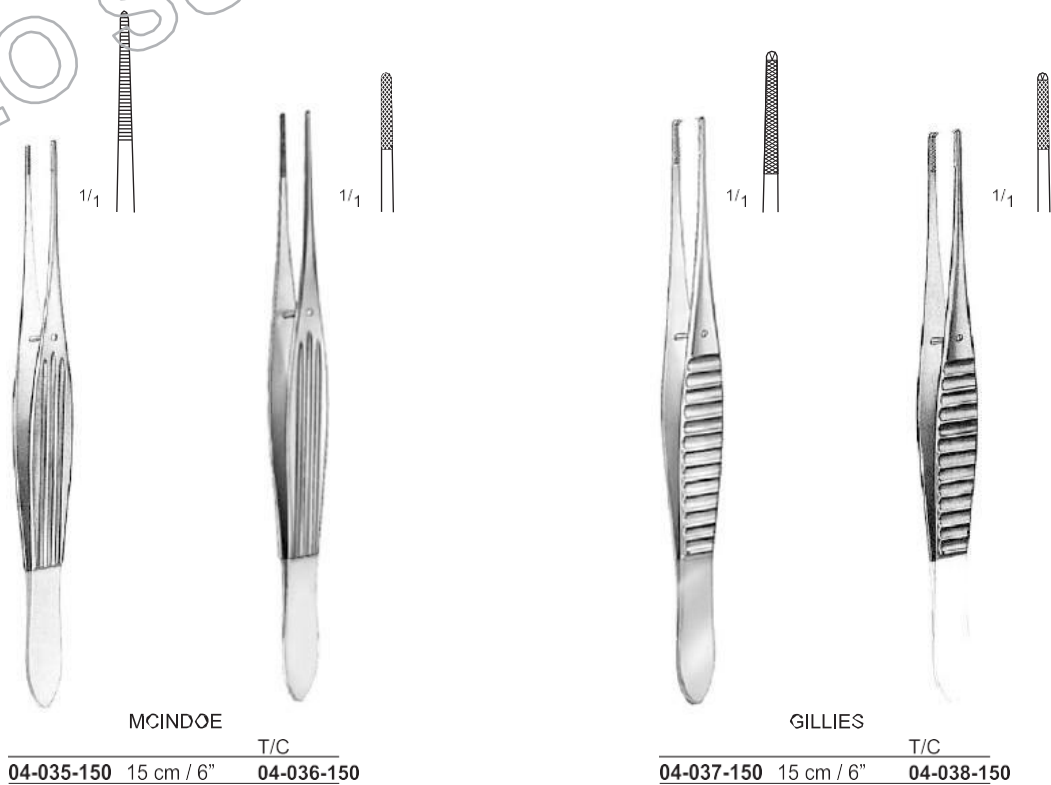

Tissue Forceps, with Tungsten Carbide T/C Inserts



1/1



1/1



1/1



WAUGH

1 x 2 teeth

T/C

15 cm / 6 "	<b>04-038-150</b>	<b>04-039-150</b>	<b>04-040-150</b>
20 cm / 8 "	<b>04-038-200</b>	<b>04-039-200</b>	<b>04-040-200</b>



**04-041-180**  
18 cm / 7 "

**04-041-200**  
20 cm / 8 "



**04-041-250**  
25 cm / 10 "



1/1

**04-042-180**  
18 cm / 7 "

**04-042-200**  
20 cm / 8 "



**04-042-250**  
25 cm / 10 "



1/1

**04-043-180**  
18 cm / 7 "

**04-043-200**  
20 cm / 8 "



**04-043-250**  
25 cm / 10 "

POTT SMITH  
05. 39.18 – 05. 39.25

POTT SMITH  
05. 41.18 – 05. 41.25  
1 x 2 teeth

POTT SMITH, T/C  
05. 39.68 – 05. 39.75



**Atraumatic Vascular Forceps**

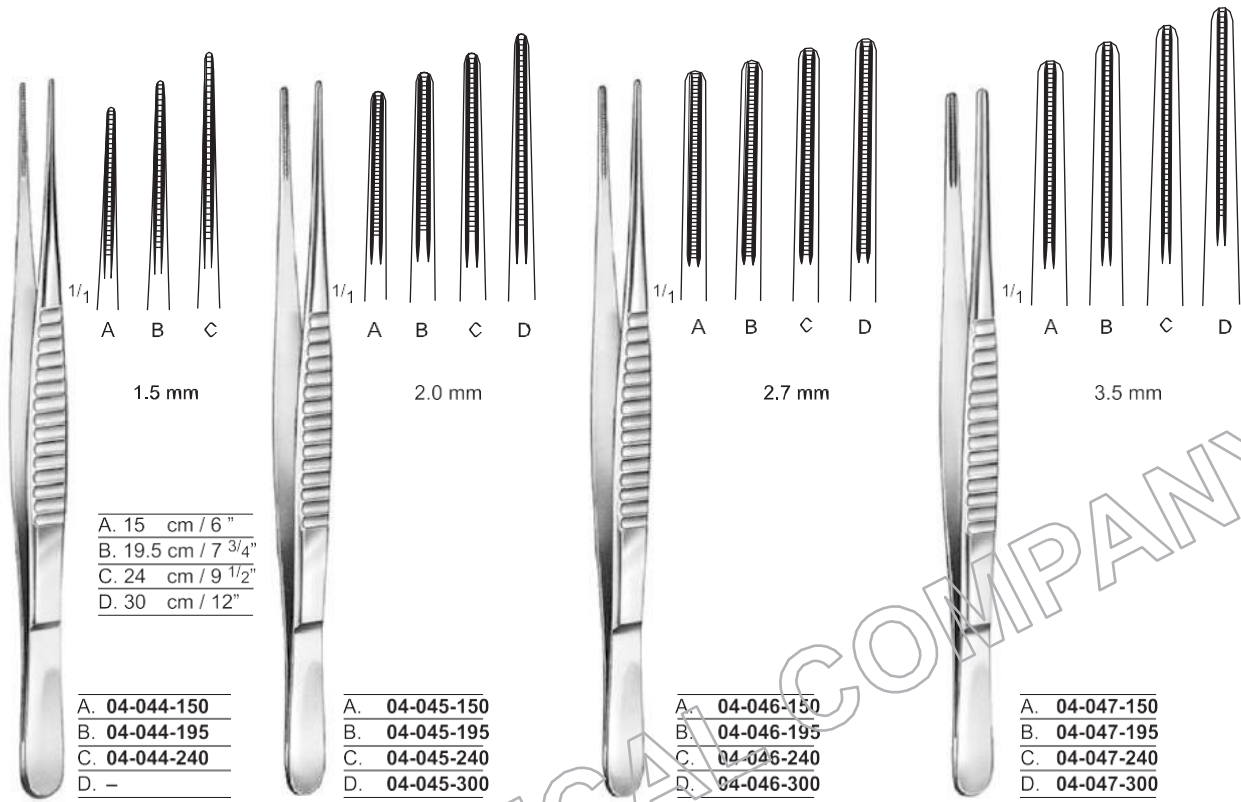

A. 15 cm / 6"  
 B. 19.5 cm / 7 3/4"  
 C. 24 cm / 9 1/2"  
 D. 30 cm / 12"

A. 04-044-150  
 B. 04-044-195  
 C. 04-044-240  
 D. -

A. 04-045-150  
 B. 04-045-195  
 C. 04-045-240  
 D. 04-045-300

A. 04-046-150  
 B. 04-046-195  
 C. 04-046-240  
 D. 04-046-300

A. 04-047-150  
 B. 04-047-195  
 C. 04-047-240  
 D. 04-047-300

DE BACKEY

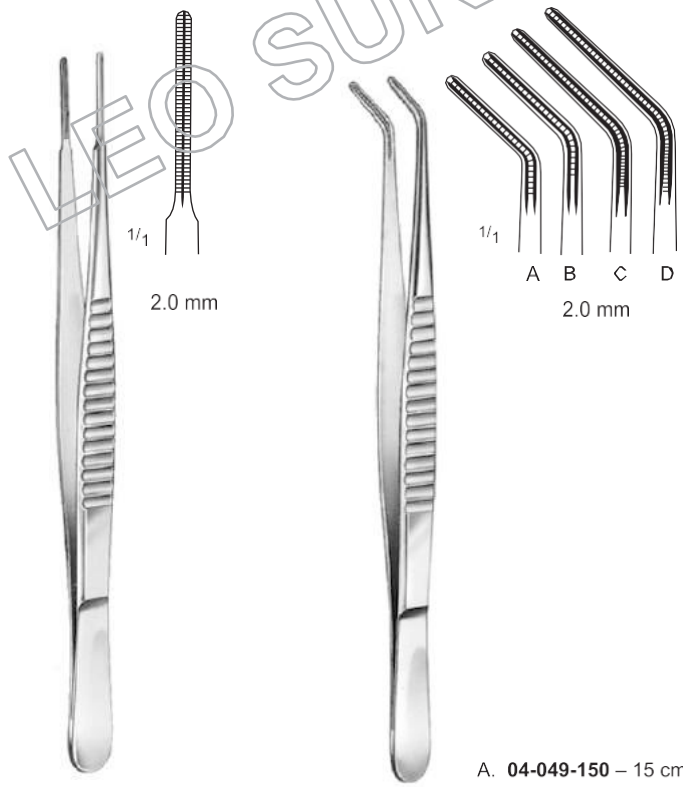

COOLEY  
 04-048-160 – 16 cm / 6 1/4"  
 04-048-200 – 20 cm / 8"

A. 04-049-150 – 15 cm / 6"  
 B. 04-049-190 – 19 cm / 7 3/4"  
 C. 04-049-240 – 24 cm / 9 1/2"  
 D. 04-049-300 – 30 cm / 12"

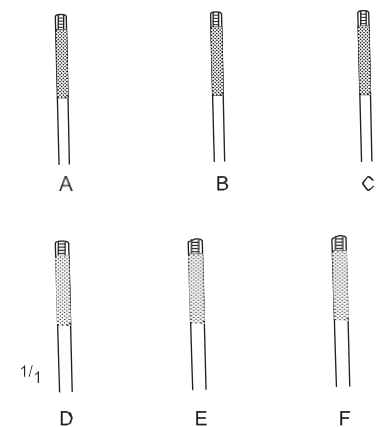

DE BAKEY T/C

Micro	Mini
A. 04-050-150 15 cm / 6"	D. 04-051-150
B. 04-050-195 19.5 cm / 7 3/4"	E. 04-051-195
C. 04-050-240 24 cm / 9 1/2"	F. 04-051-240

**Delicate Tissue Forceps, with Tungsten Carbide T/C Inserts**

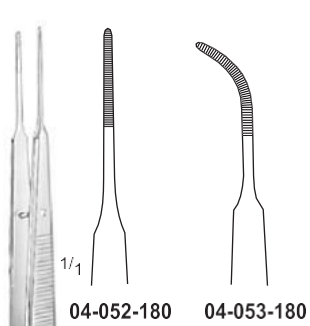

GEARLD  
 18 cm / 7"

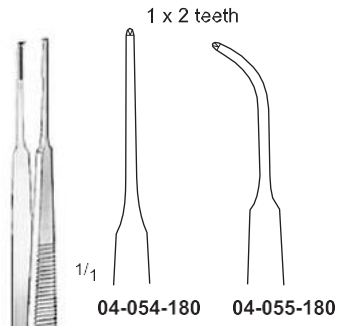

GEARLD  
 18 cm / 7"

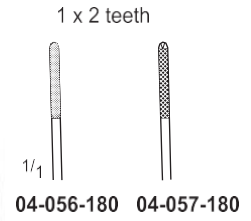

GEARLD, T/C  
 18 cm / 7"

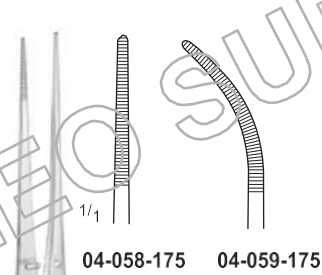

CUSHING  
 17.5 cm / 7"

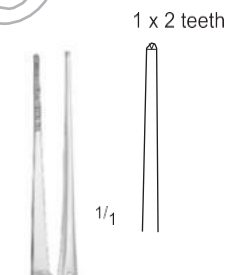

CUSHING  
 04-060-175  
 17.5 cm / 7"

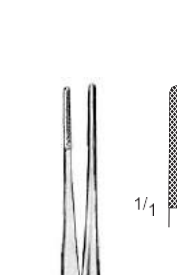

CUSHING T/C  
 04-061-175  
 17.5 cm / 7"

LEO SURGICAL COMPANY

Tissue Grasping Forceps, with Tungsten Carbide T/C Inserts

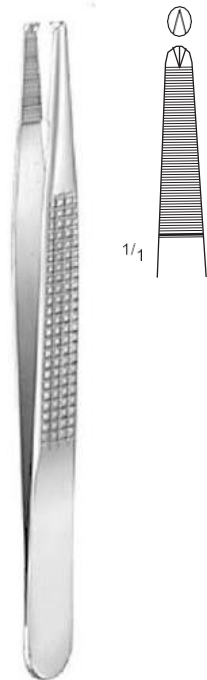

**BONNEY**  
**04-062-180**  
 18 cm / 7"

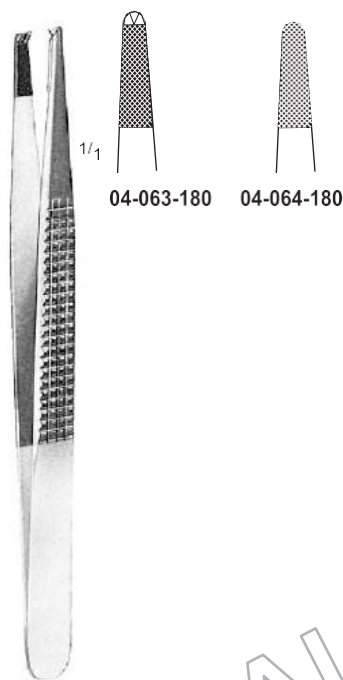

**BONNEY T/C**  
 18 cm / 7"



**TAYLOR**  
**04-065-175**  
 17.5 cm / 7"



**TAYLOR**  
**04-066-175**  
 17.5 cm / 7"



**TAYLOR**  
**04-067-175**  
 17.5 cm / 7"



**TAYLOR**  
**04-068-175**  
 17.5 cm / 7"



**TAYLOR**  
**04-069-175**  
 17.5 cm / 7"



**TAYLOR**  
**04-070-175**  
 17.5 cm / 7"



**TAYLOR, T/C**  
**04-071-175**  
 17.5 cm / 7"

Tissue Grasping Forceps

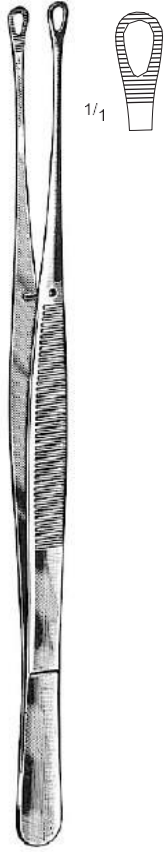

TUTTLE (SINGLEY)  
 04-072-180 – 18 cm / 7"  
 04-072-230 – 23 cm / 9"



RUSSIAN PATTERN

04-073-150  
15 cm / 6"

04-073-200  
20 cm / 8"

04-073-250  
25 cm / 10"

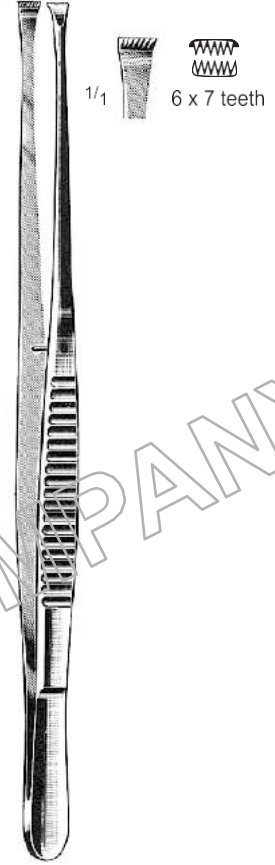

NELSON  
 04-074-150 – 15 cm / 6"  
 04-074-230 – 23 cm / 9"

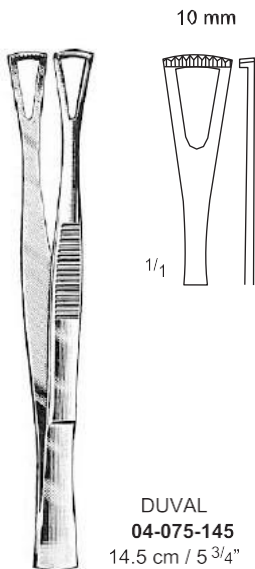

DUVAL  
 04-075-145  
 14.5 cm / 5 3/4"

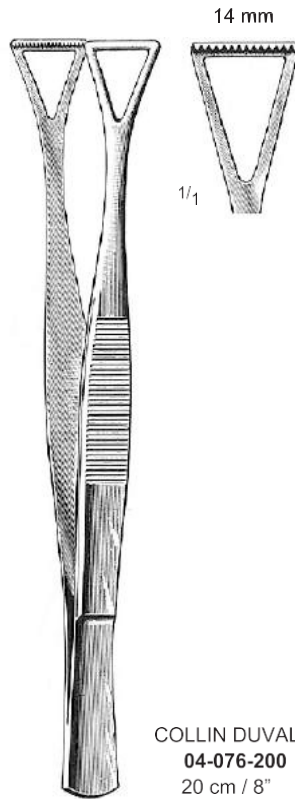

COLLIN DUVAL  
 04-076-200  
 20 cm / 8"

LEO SURGICAL COMPANY

Ear and Nasal Dressing Forceps

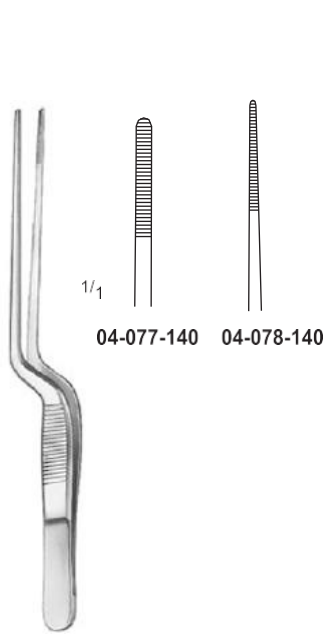

1/1  
 04-077-140 04-078-140

LUCAE  
 14 cm / 5 1/2"

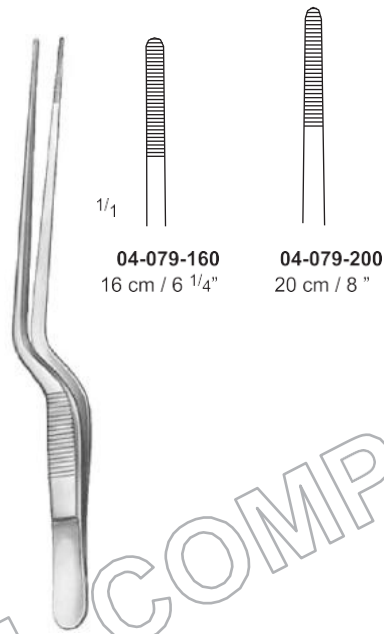

1/1  
 04-079-160 04-079-200  
 16 cm / 6 1/4" 20 cm / 8"

GRUENWALD (JANSEN)

LEO SURGICAL COMPANY

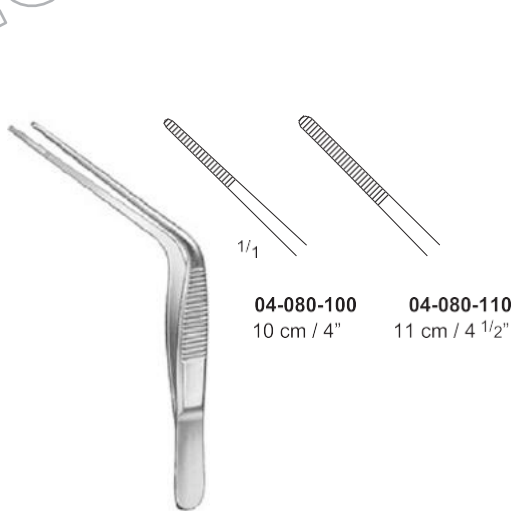

1/1  
 04-080-100 04-080-110  
 10 cm / 4" 11 cm / 4 1/2"

TROELTSCH (WILDE)

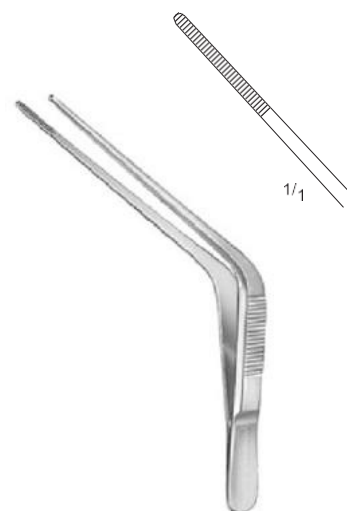

1/1  
 TROELTSCH (WILDE)  
 04-081-130  
 13 cm / 5"

**Delicate Pattern Forceps, Splinter Forceps**

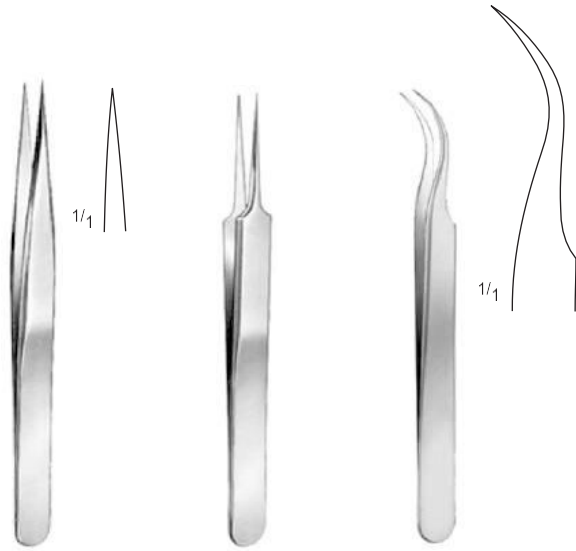

JEWELLER STYLE

<b>04-082-003</b>	<b>04-082-005</b>	<b>04-082-007</b>
No. 3	No. 5	No. 7
11.5 cm / 4 1/2"	11 cm / 4 1/4"	11.5 cm / 4 1/2"

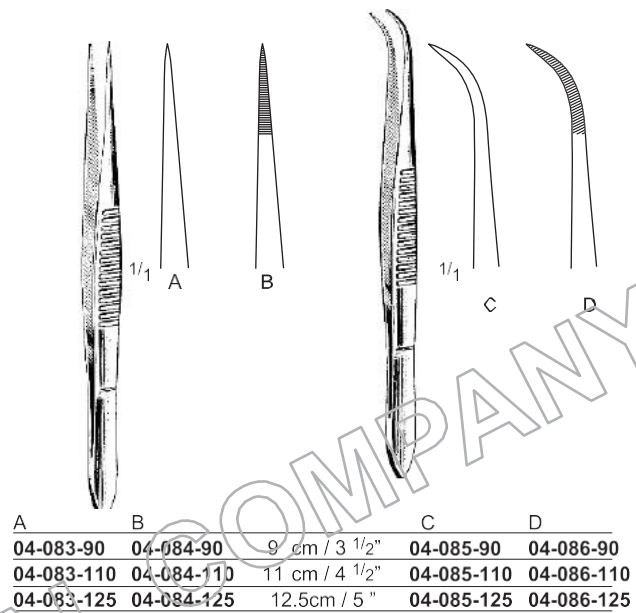

<b>A</b>	<b>B</b>	<b>C</b>	<b>D</b>
<b>04-083-90</b>	<b>04-084-90</b>	9 cm / 3 1/2"	<b>04-085-90</b>
<b>04-083-110</b>	<b>04-084-110</b>	11 cm / 4 1/2"	<b>04-085-110</b>
<b>04-083-125</b>	<b>04-084-125</b>	12.5cm / 5 "	<b>04-085-125</b>
			<b>04-086-90</b>
			<b>04-086-110</b>
			<b>04-086-125</b>

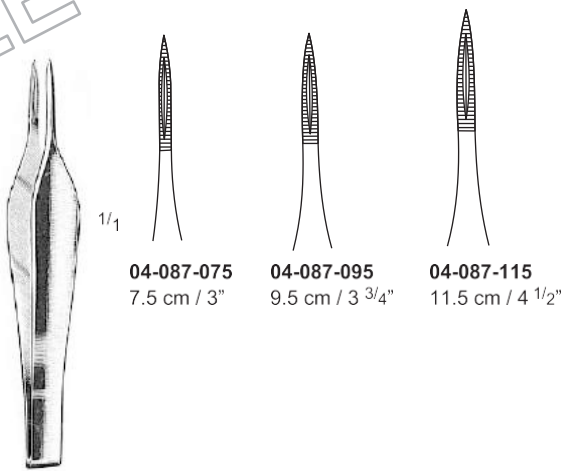

FEILCHENFELD

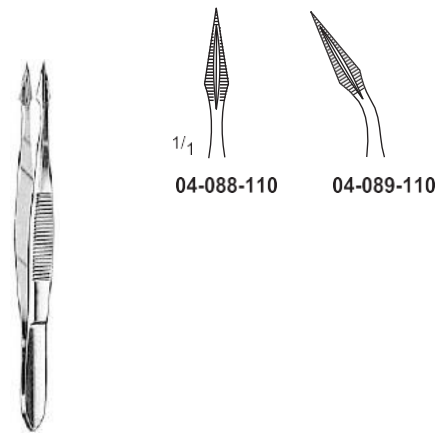

HUNTER  
 11 cm / 4 1/2"

Cilia Forceps, Splinter Forceps

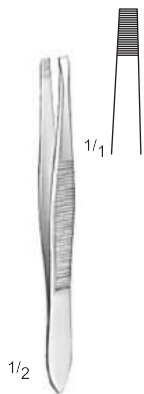

DOUGLAS  
**04-090-090**  
 9 cm / 3 1/2"



DOUGLAS  
**04-091-090**  
 9 cm / 3 1/2"

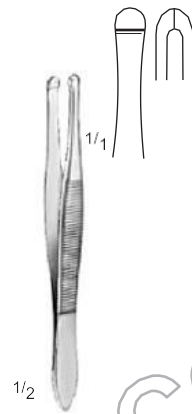

BEER  
**04-092-090**  
 9 cm / 3 1/2"



BARRAQUER  
**04-093-105**  
 10.5 cm / 4 1/4"



STEIGLITZ  
 14 cm / 5 1/2"

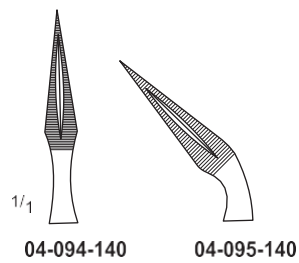

04-094-140

04-095-140



RALKS  
 14.5 cm / 5 1/2"

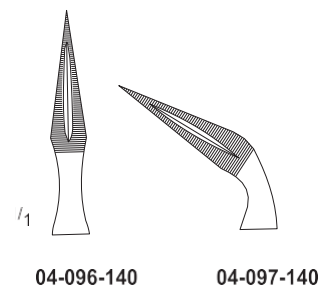

04-096-140

04-097-140

Micro Eye Forceps, Chalazion Forceps

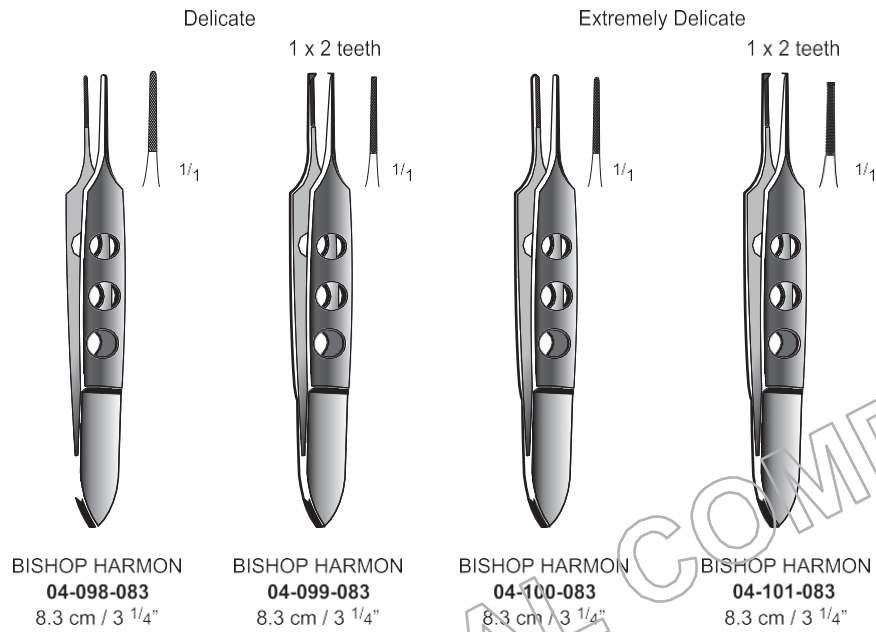

DESMARRES  
9.5 cm / 3 3/4"

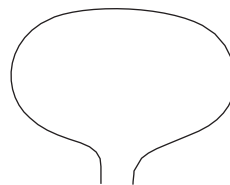

04-102-095

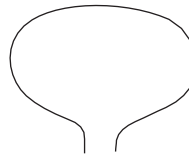

04-103-095

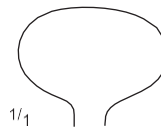

04-104-095

LEO SURGICAL COMPANY



# SPONGE FORCEPS



Sinus & Dressing Forceps

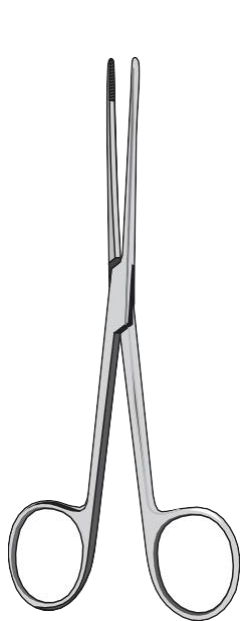

LISTER



05-001-130  
 13 cm / 5 1/8"



05-001-115  
 15 cm / 6"



05-001-180  
 18 cm / 7"

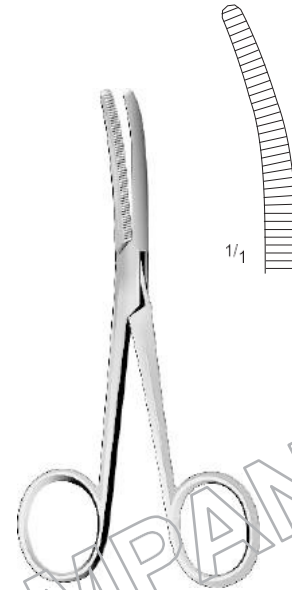

BRYANT  
 05-002-130  
 13 cm / 5"



GROSS MAIER



05-003-200  
 20 cm / 8"



05-003-220  
 22 cm / 8 3/4"

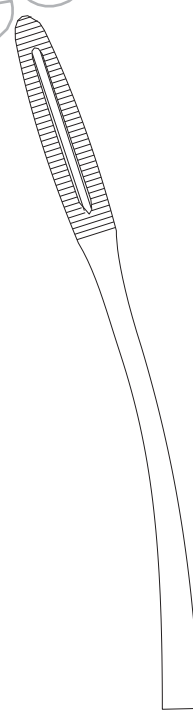

05-003-260  
 26 cm / 10 1/4"

05-004-200  
 05-004-220  
 05-004-260

LEO SURGICAL COMPANY

Swab Forceps, Sponge Holding Forceps

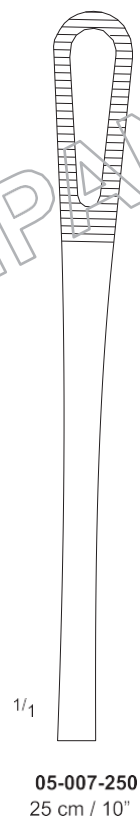

Dressing & Sponge Forceps

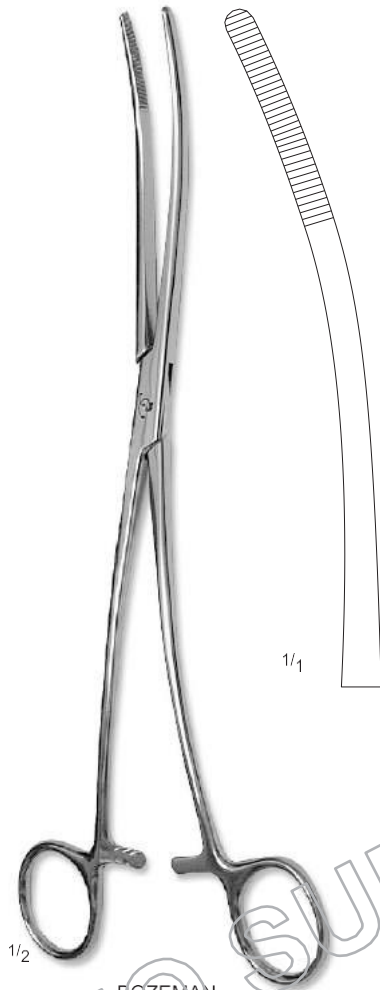

1/2  
 BOZEMAN  
 05-008-260  
 26 cm / 10 1/4"

1/1

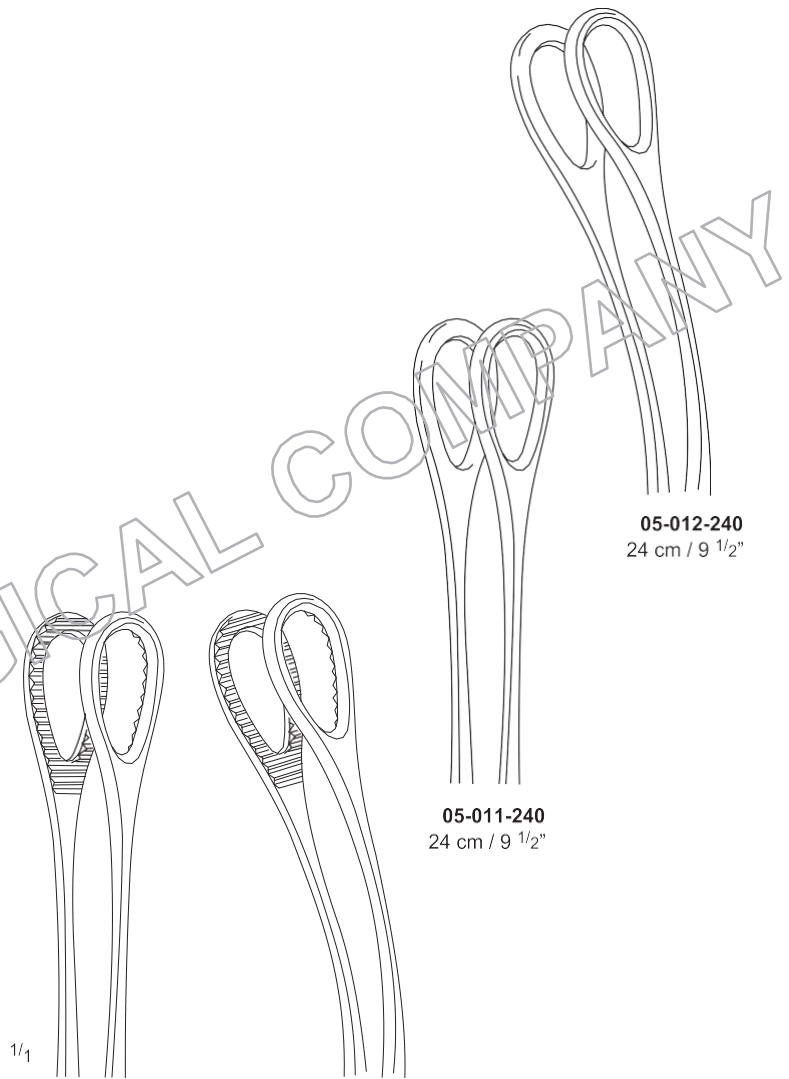

05-012-240  
 24 cm / 9 1/2"

05-011-240  
 24 cm / 9 1/2"

1/1

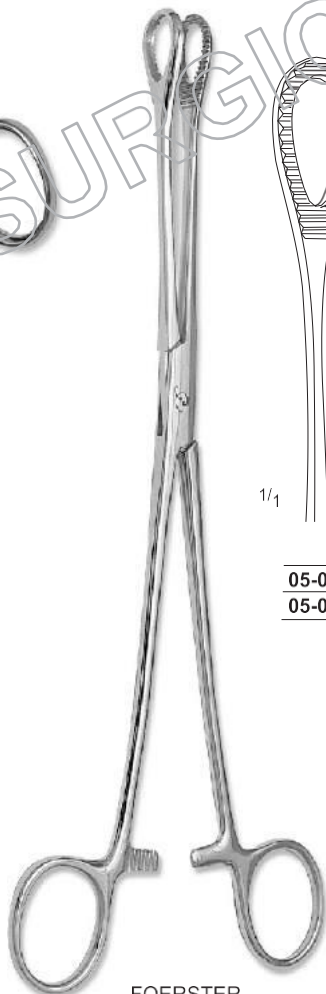

FOERSTER

05-009-180	-	18 cm / 7 1/8"	-	05-010-180
05-009-240	-	24 cm / 9 1/2"	-	05-010-240

# Hemostatic Forceps

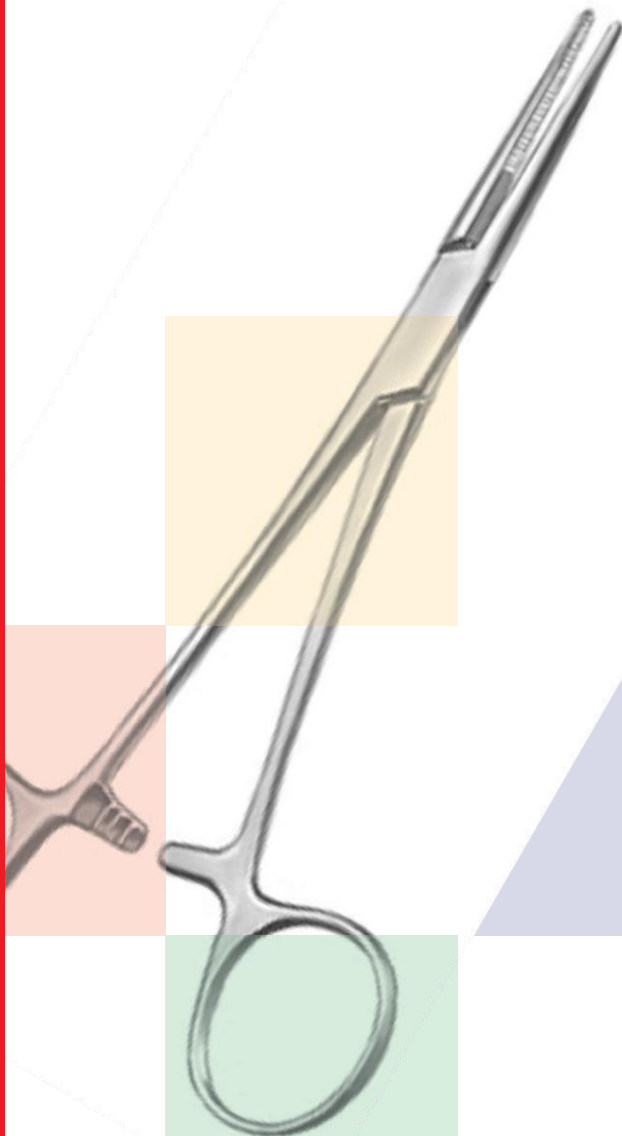

**Bulldog Clamps**

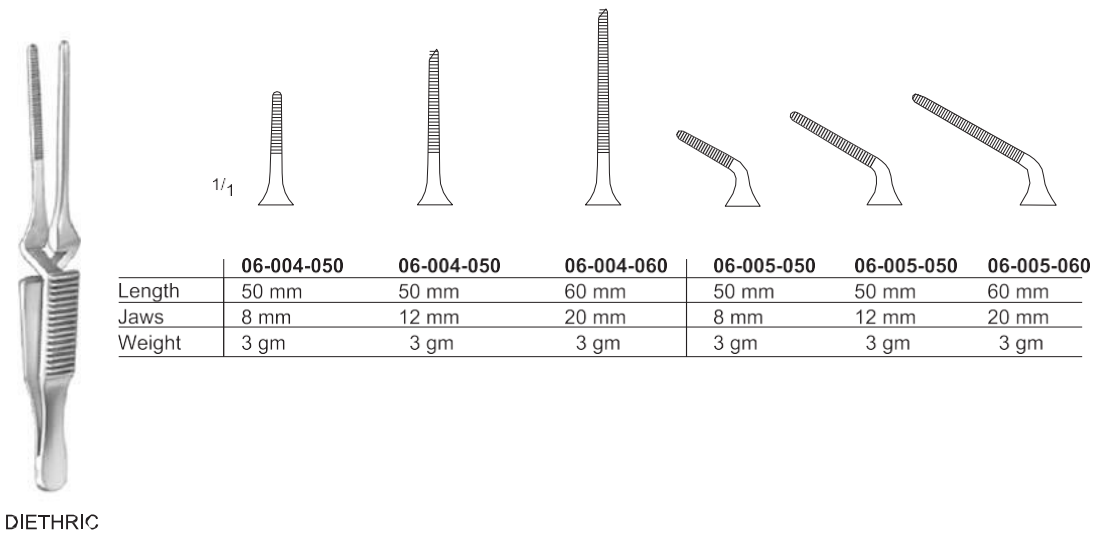
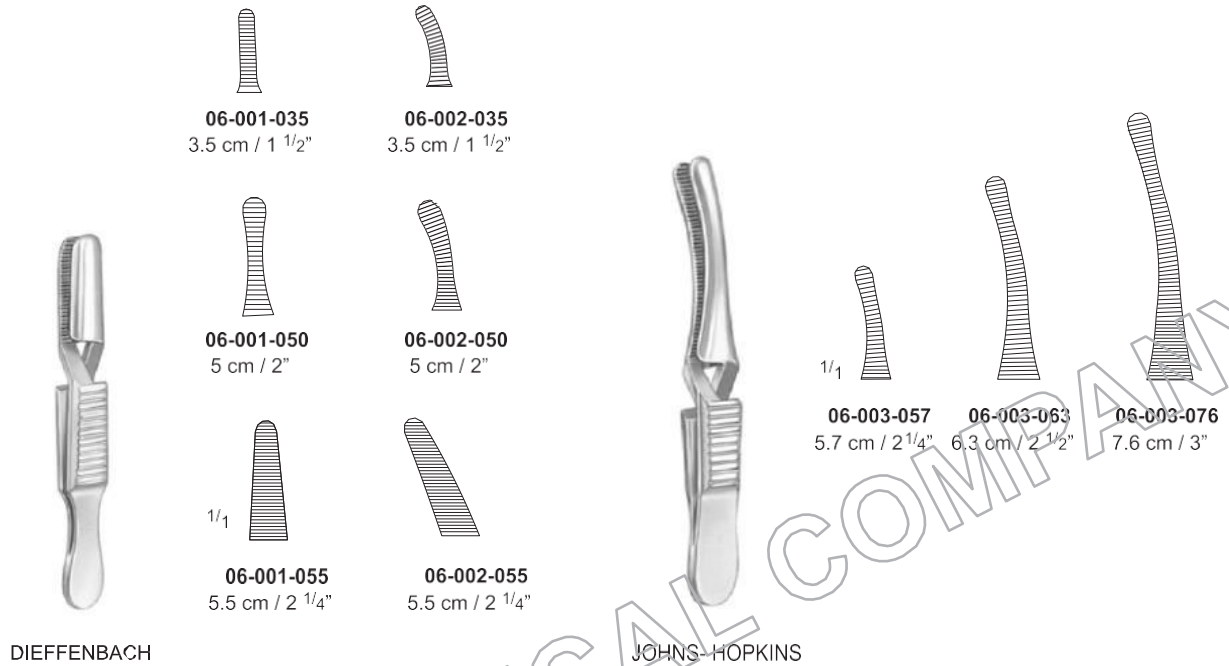

	<b>06-004-050</b>	<b>06-004-050</b>	<b>06-004-060</b>	<b>06-005-050</b>	<b>06-005-050</b>	<b>06-005-060</b>
Length	50 mm	50 mm	60 mm	50 mm	50 mm	60 mm
Jaws	8 mm	12 mm	20 mm	8 mm	12 mm	20 mm
Weight	3 gm	3 gm	3 gm	3 gm	3 gm	3 gm

Artery Forceps



**06-006-125**  
12.5 cm / 5"

**06-006-140**  
14 cm / 5 1/2"

**06-007-125**  
12.5 cm / 5"

**06-007-140**  
14 cm / 5 1/2"

**06-008-125**  
12.5 cm / 5"  
1 x 2 teeth

**06-008-140**  
14 cm / 5 1/2"  
1 x 2 teeth

**06-009-125**  
12.5 cm / 5"  
1 x 2 teeth

**06-009-140**  
14 cm / 5 1/2"  
1 x 2 teeth

1/2

HALSTEAD MOSQUITO



**06-010-125**  
12.5 cm / 5"

**06-011-125**  
12.5 cm / 5"

**06-012-125**  
12.5 cm / 5"  
1 x 2 teeth

**06-013-125**  
12.5 cm / 5"  
1 x 2 teeth

1/2

MICRO- HALSTEAD MOSQUITO

Artery Forceps



CHAPUT  
 06-014-130  
 13 cm / 5"



TUFFIER  
 06-015-130  
 13 cm / 5"

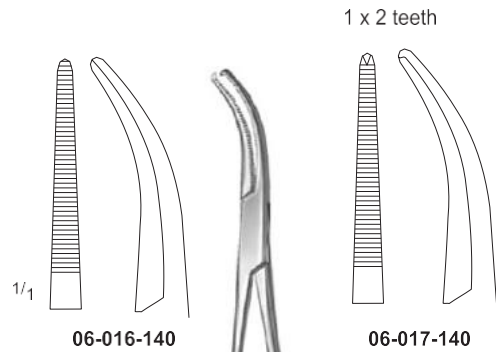

06-016-140

06-017-140

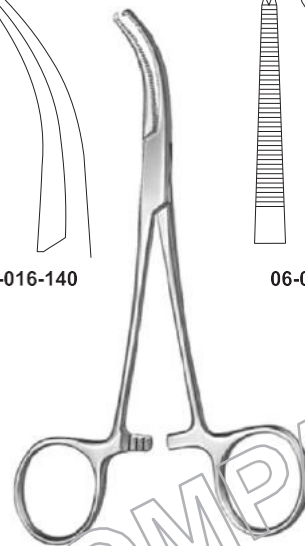

DANDY  
 14 cm / 5 1/2"

LEO SURGICAL COMPANY

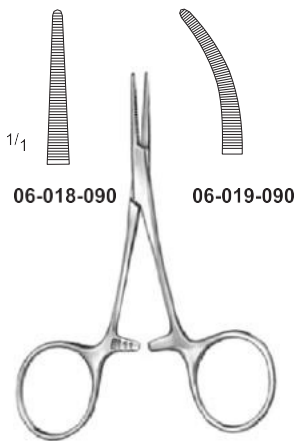

06-018-090 06-019-090

HARTMANN  
 (BABY MOSQUITO)  
 9 cm / 3 1/2"

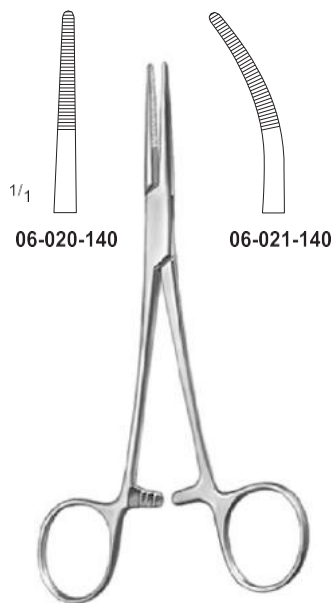

06-020-140

06-021-140

PROVIDENCE HOSPITAL  
 14 cm / 5 1/2"

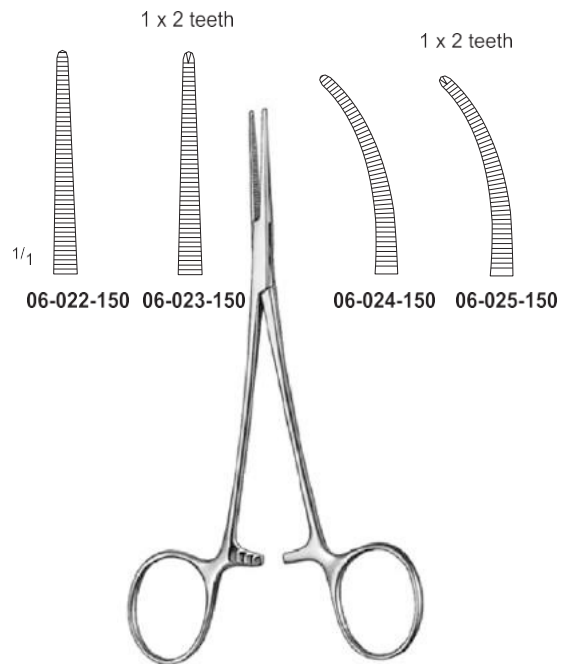

06-022-150

06-023-150

06-024-150

06-025-150

LERICHE  
 15 cm / 6"



Artery Forceps

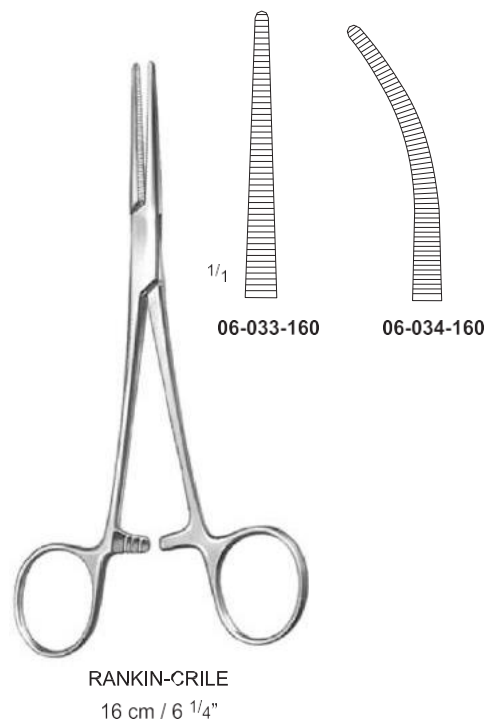
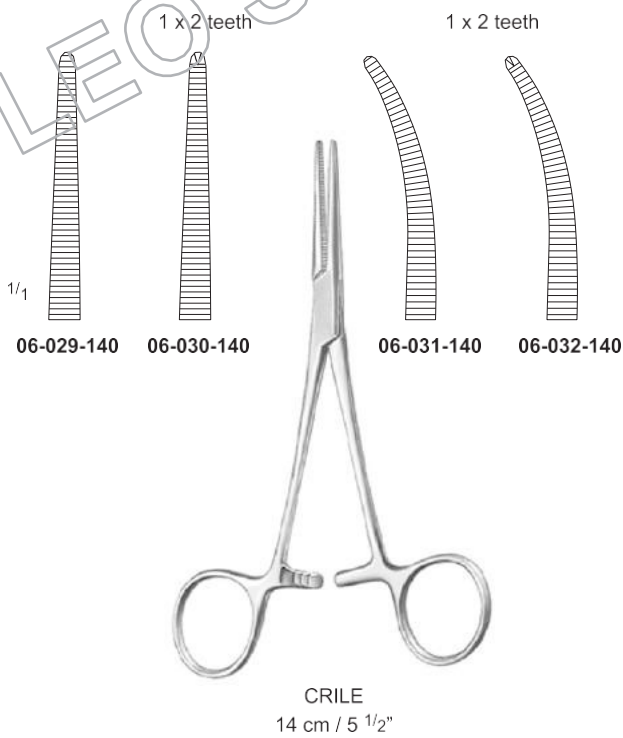
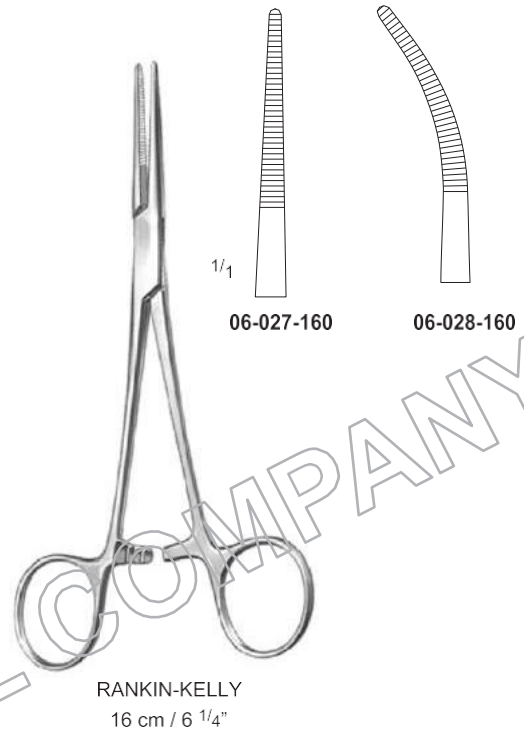
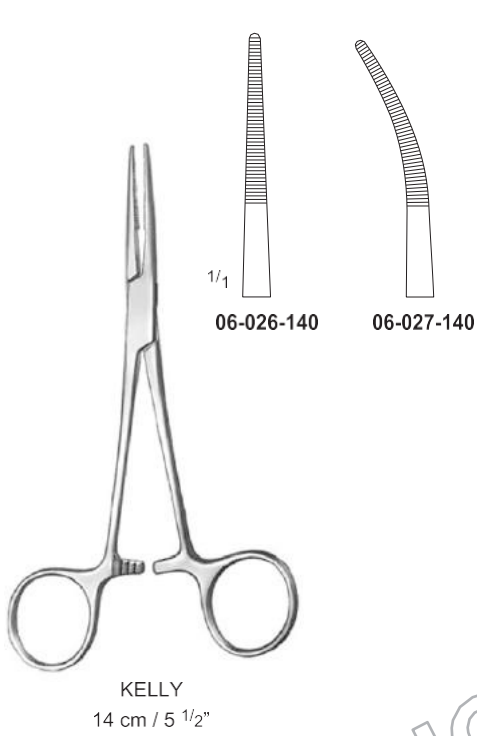

Artery Forceps

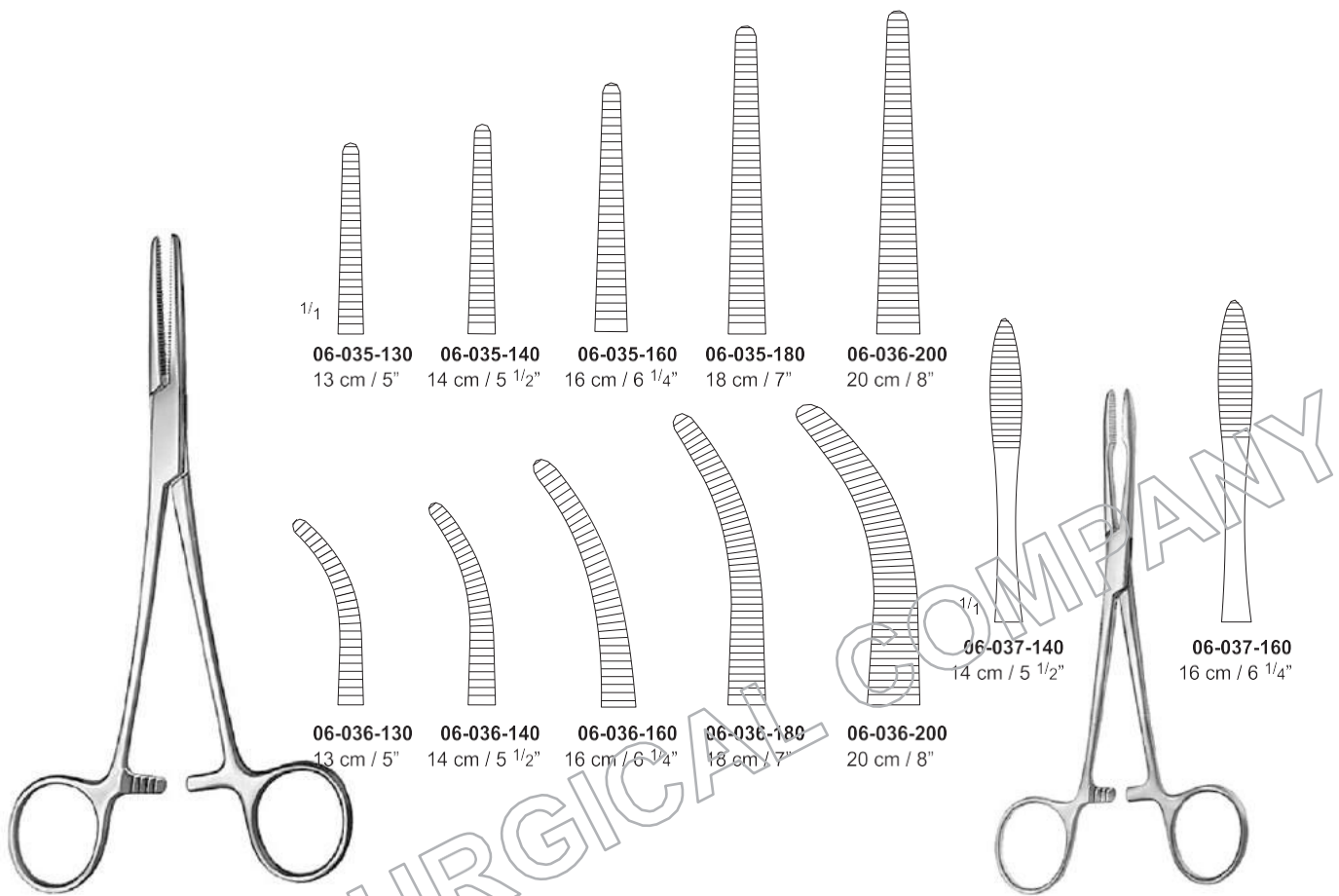

1/1

06-035-130 13 cm / 5"  
 06-035-140 14 cm / 5 1/2"  
 06-035-160 16 cm / 6 1/4"  
 06-035-180 18 cm / 7"  
 06-036-200 20 cm / 8"

06-036-130 13 cm / 5"  
 06-036-140 14 cm / 5 1/2"  
 06-036-160 16 cm / 6 1/4"  
 06-036-180 18 cm / 7"  
 06-036-200 20 cm / 8"

06-037-140 14 cm / 5 1/2"

06-037-160 16 cm / 6 1/4"

SPENCER WELLS

PEAN

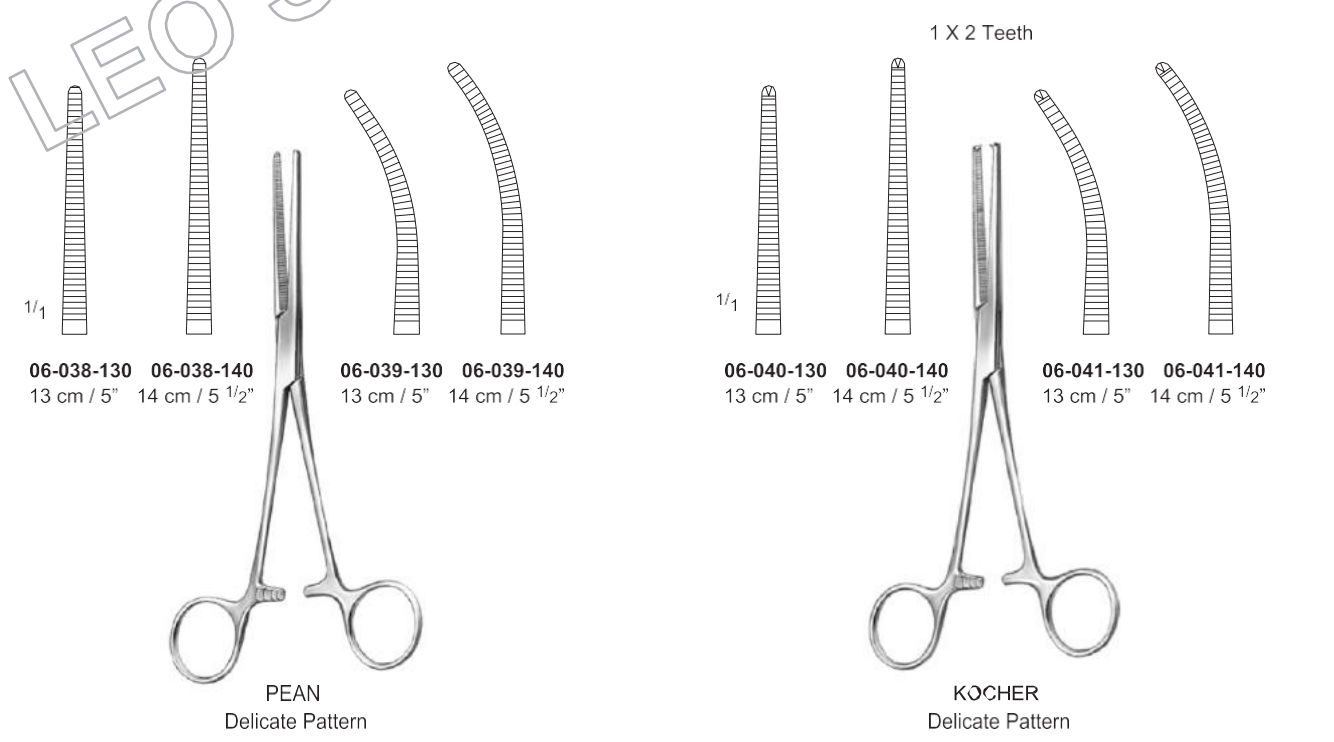

1/1

06-038-130 13 cm / 5"  
 06-038-140 14 cm / 5 1/2"

06-039-130 13 cm / 5"  
 06-039-140 14 cm / 5 1/2"

1/1

06-040-130 13 cm / 5"  
 06-040-140 14 cm / 5 1/2"

06-041-130 13 cm / 5"  
 06-041-140 14 cm / 5 1/2"

1 X 2 Teeth

PEAN  
 Delicate Pattern

KOCHER  
 Delicate Pattern

Artery Forceps

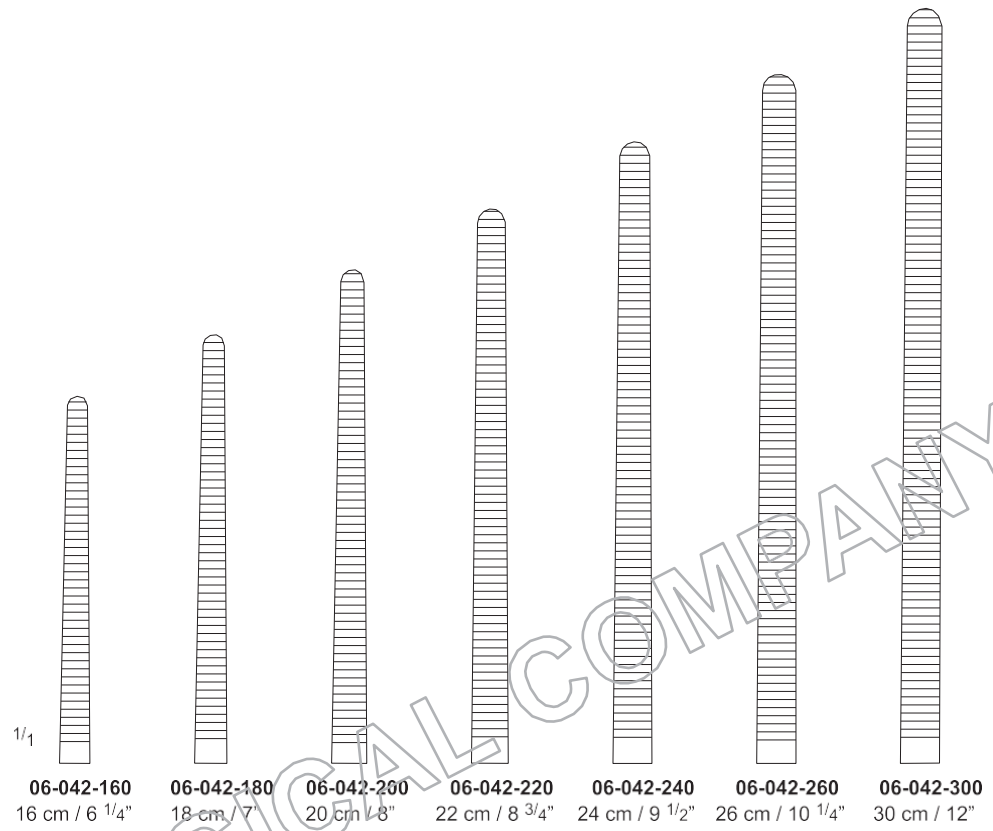

PEAN (ROCHESTER)

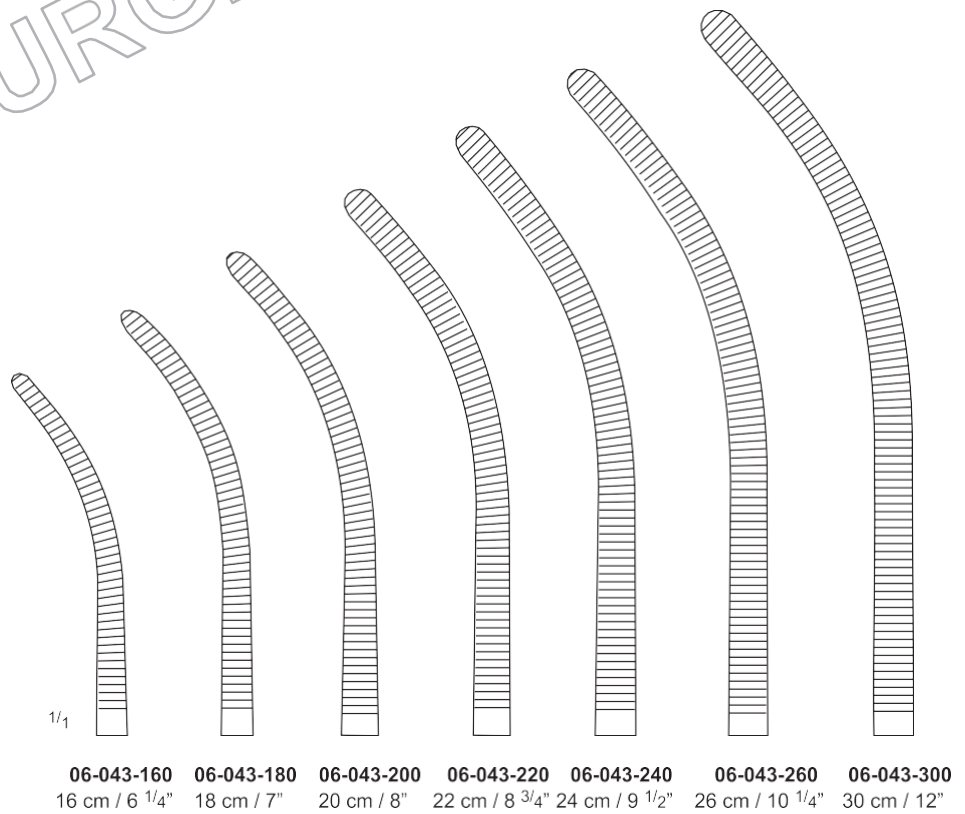

Artery Forceps

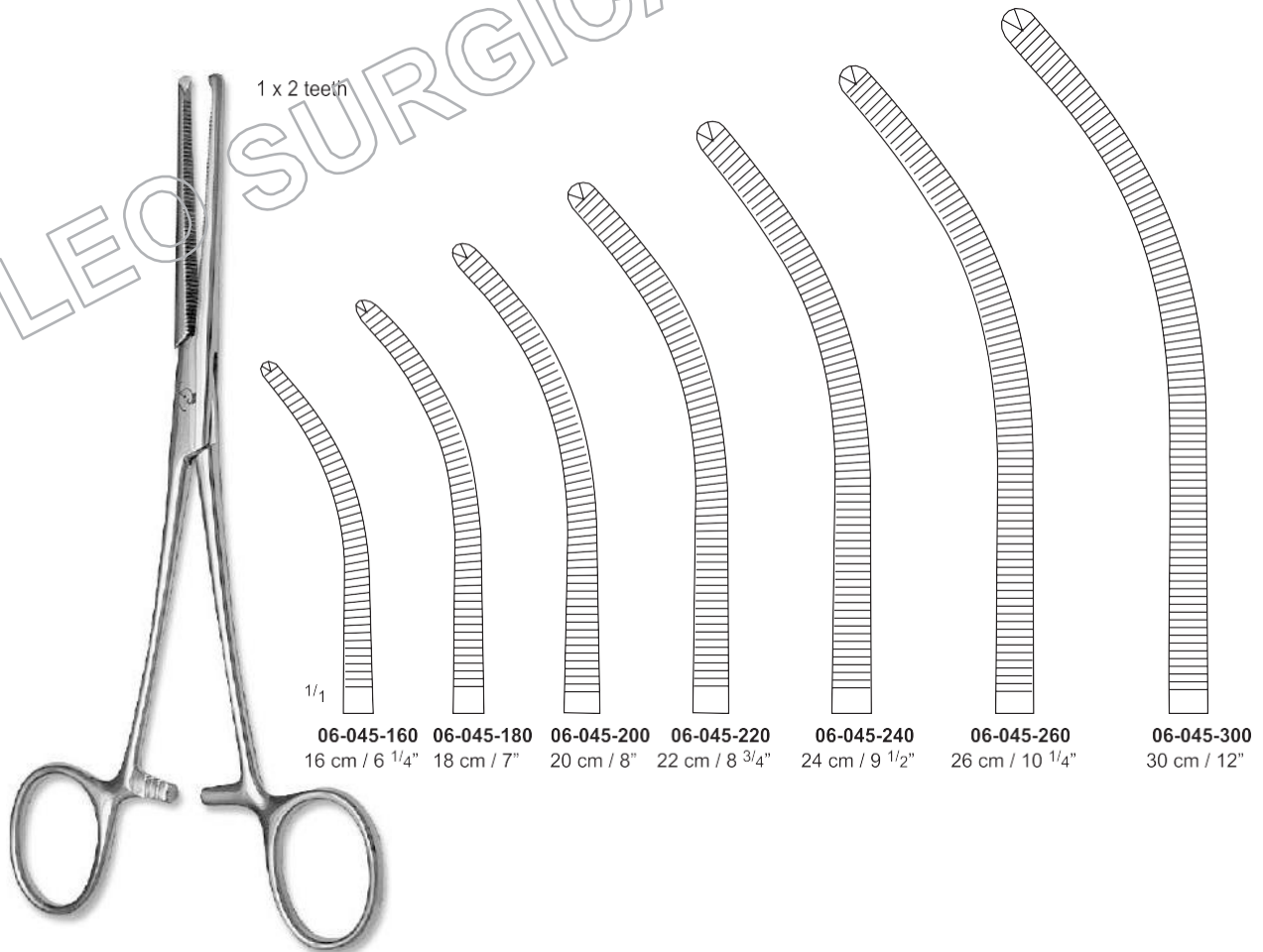
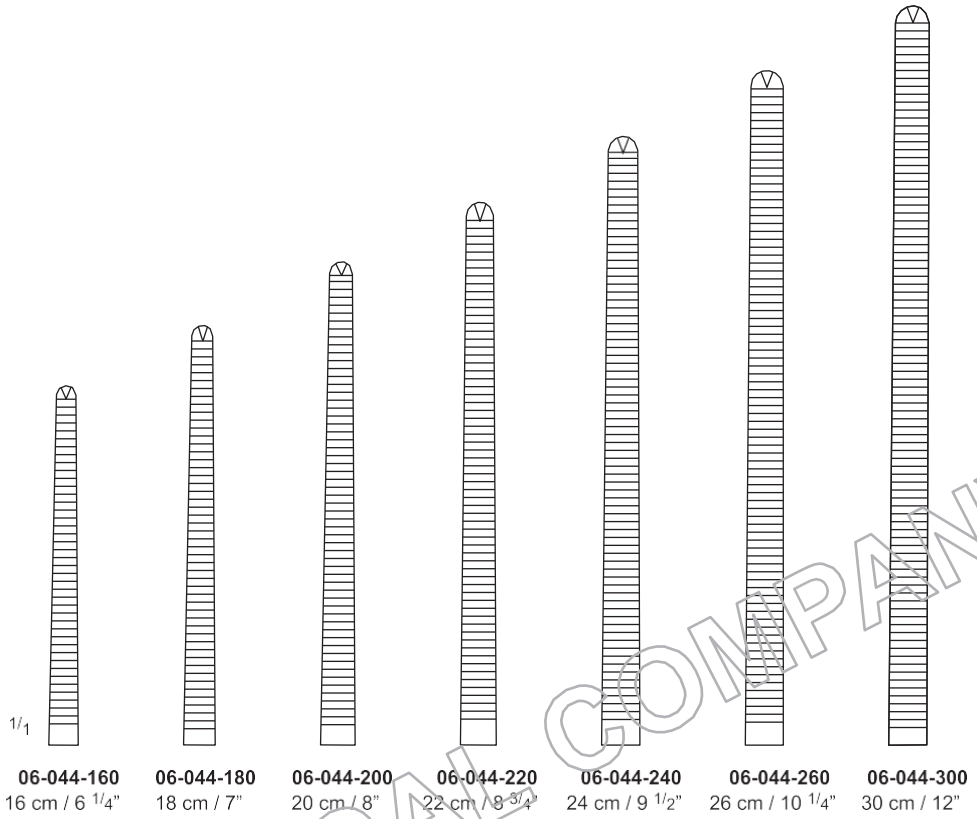

Artery Forceps



BENGOLEA

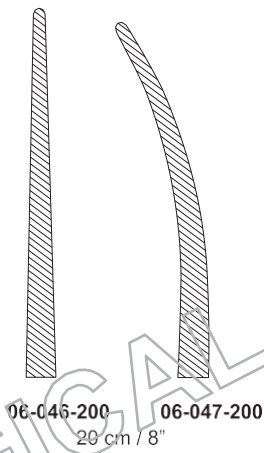

06-046-200 06-047-200  
 20 cm / 8"

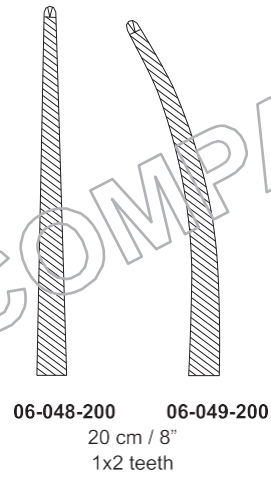

06-048-200 06-049-200  
 20 cm / 8"  
 1x2 teeth

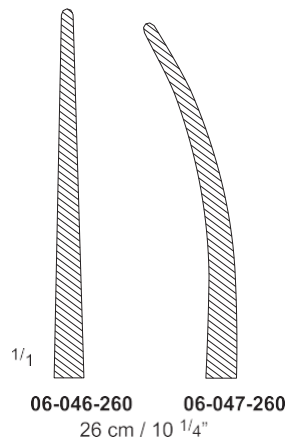

1/1  
 06-046-260 06-047-260  
 26 cm / 10 1/4"

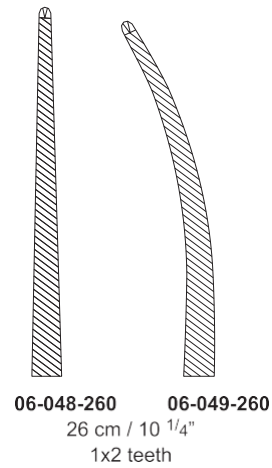

06-048-260 06-049-260  
 26 cm / 10 1/4"  
 1x2 teeth

Artery Forceps, Dissecting & Ligature Forceps

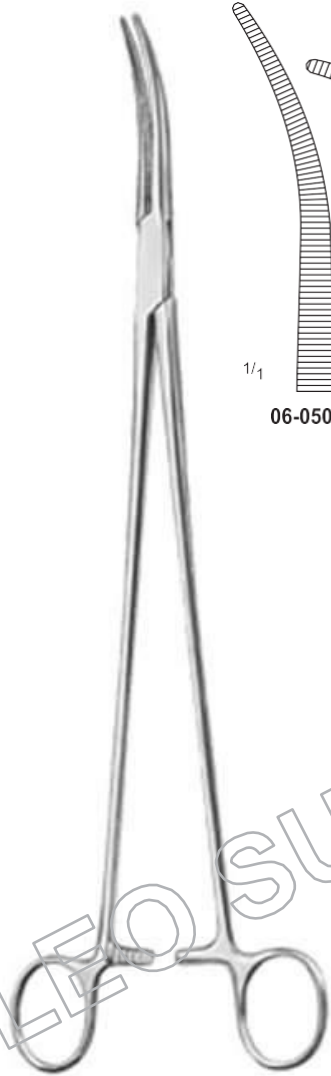

ZENKER  
29.5 cm / 11 1/2"

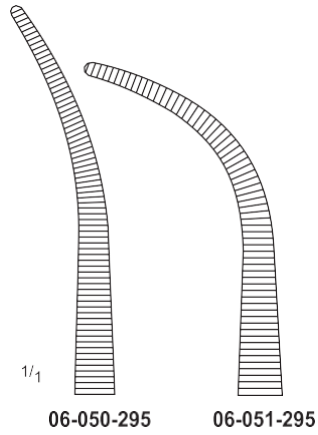

RUMEL  
23 cm / 9"

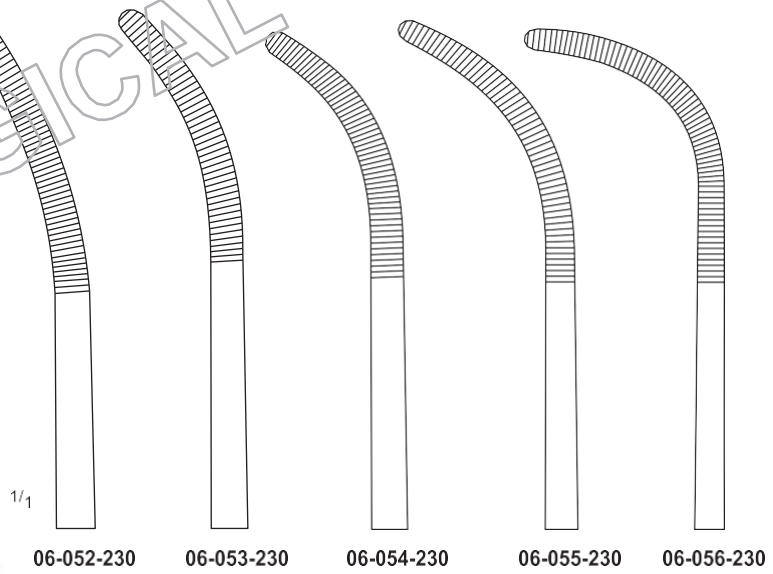

Artery Forceps, Hysterectomy and Vaginal Clamp Forceps

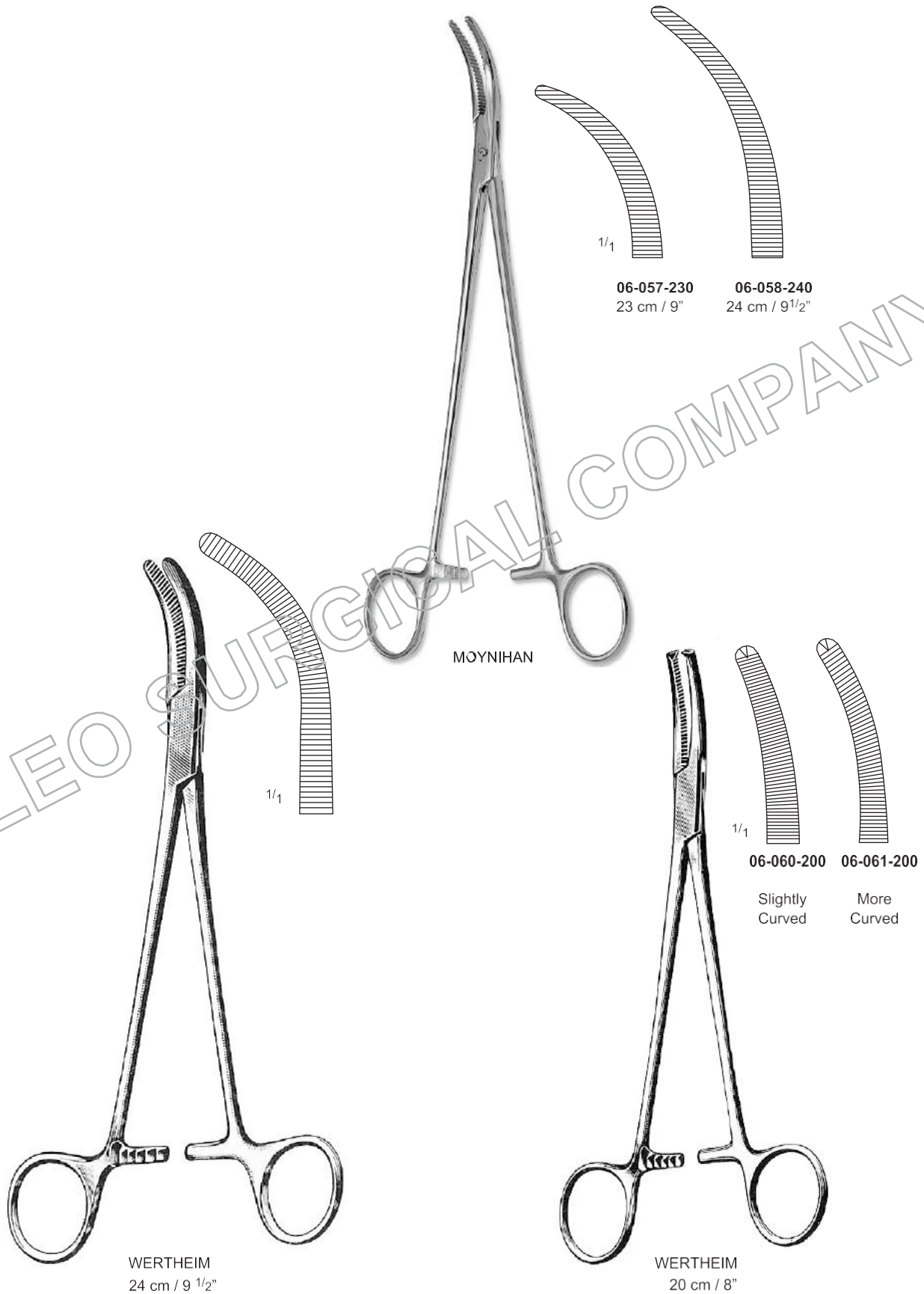

Artery Forceps, Clamps

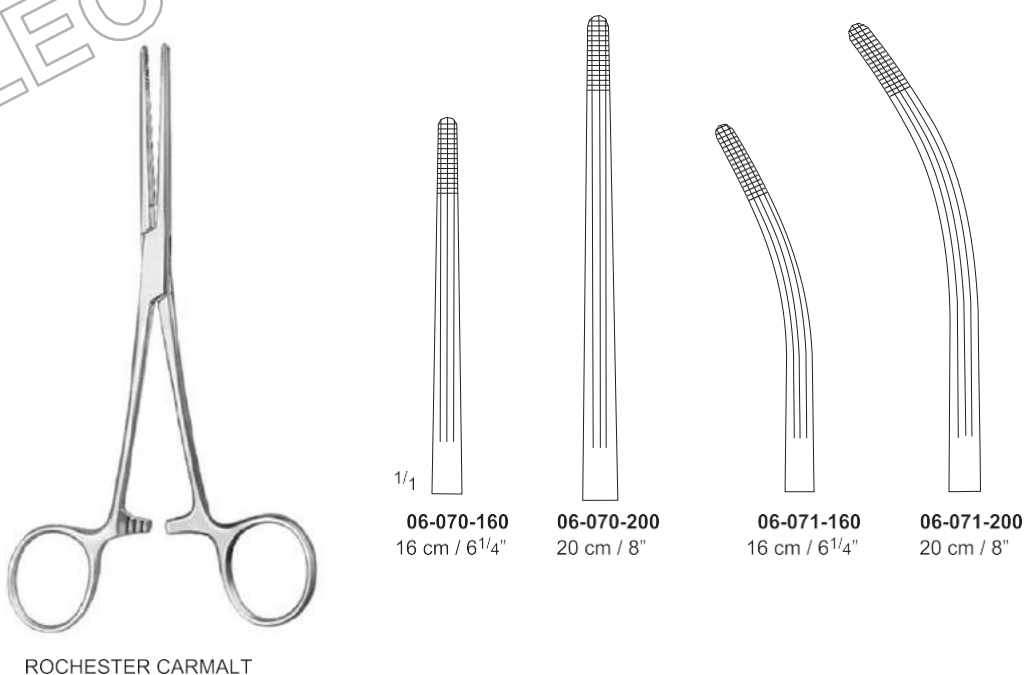
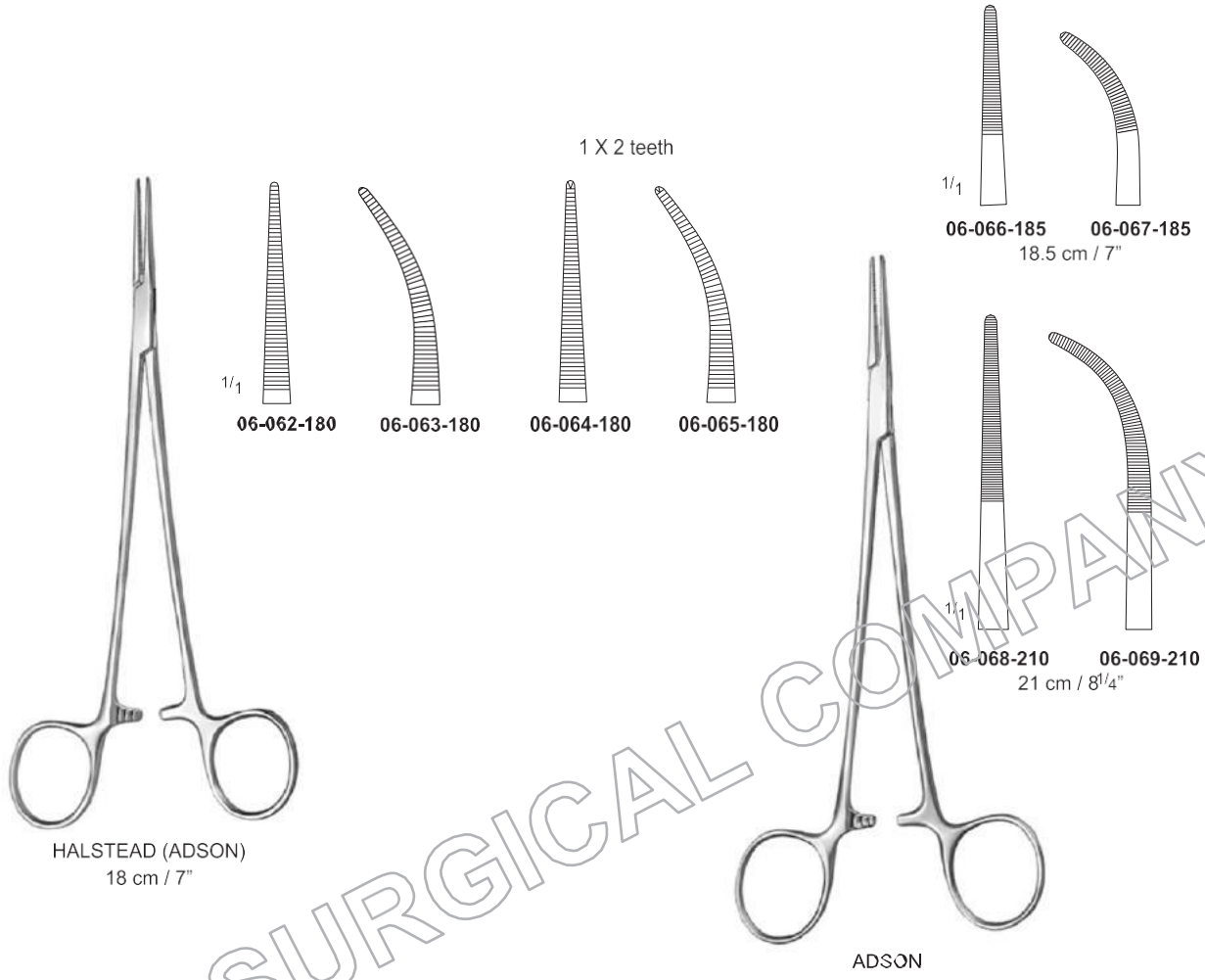

LEO SURGICAL COMPANY



Peritoneal Clamp Forceps

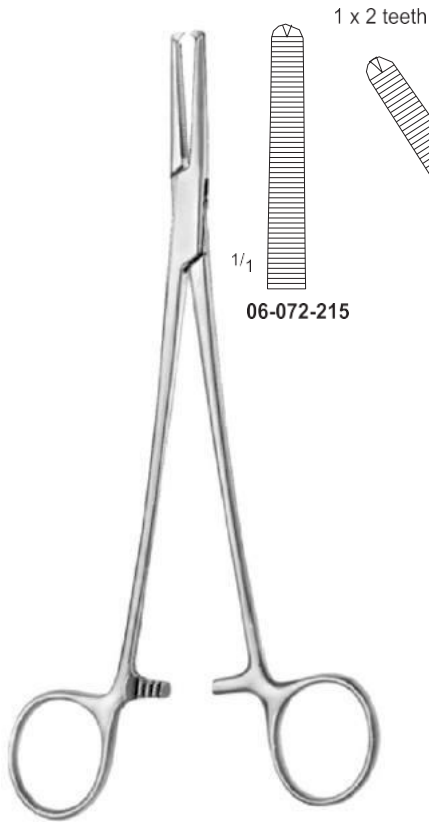

1/1

06-072-215

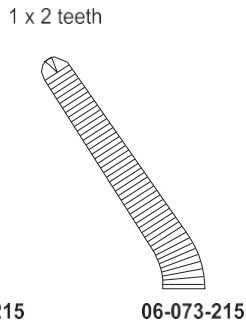

PHANEUF  
 21.5 cm / 8 1/2"

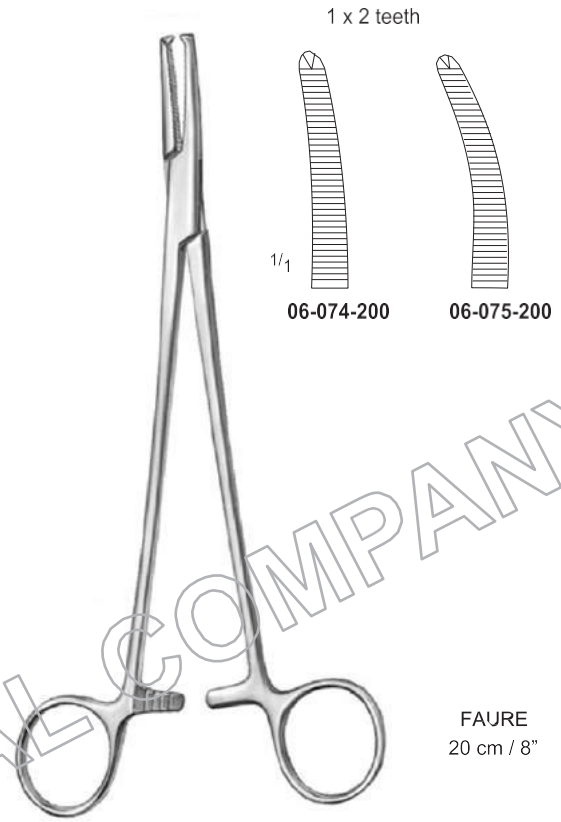

1/1

06-074-200

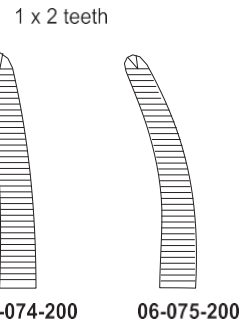

FAURE  
 20 cm / 8"

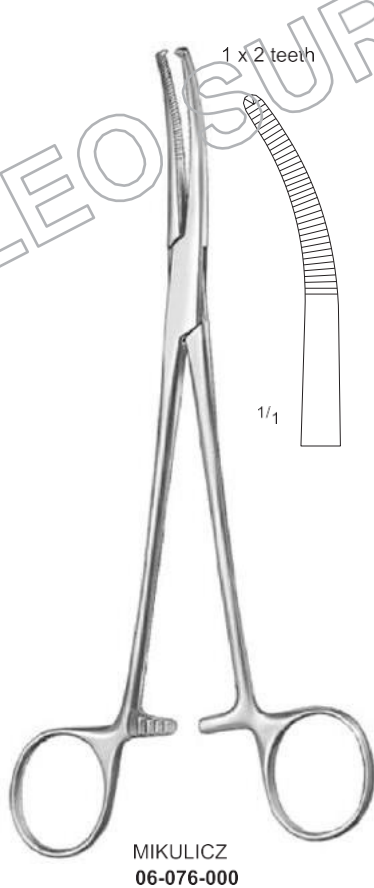

1 x 2 teeth

1/1

MIKULICZ  
 06-076-000

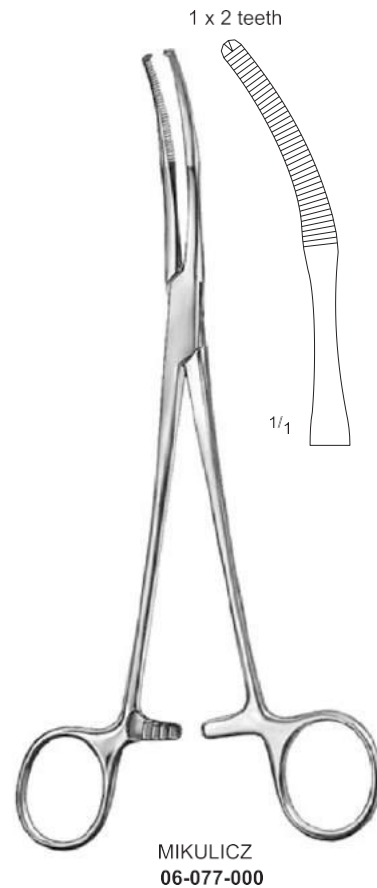

1 x 2 teeth

1/1

MIKULICZ  
 06-077-000

Artery Forceps, Dissecting and Ligature Forceps

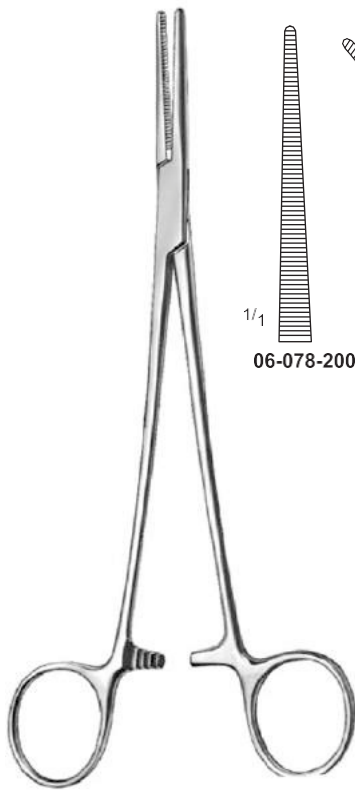

HEISS  
 20 cm / 8"

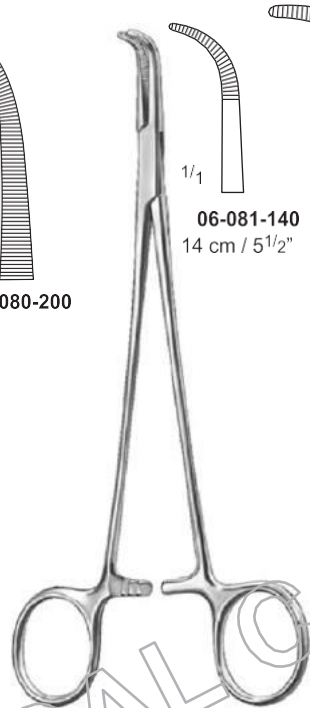
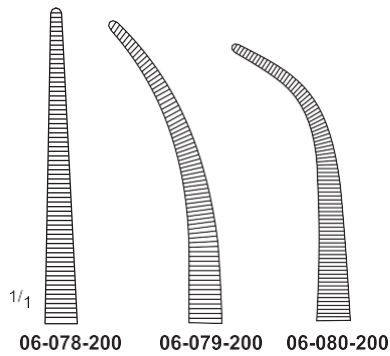

ADSON BABY

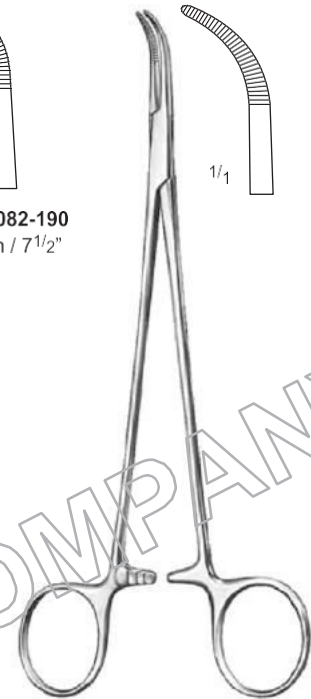
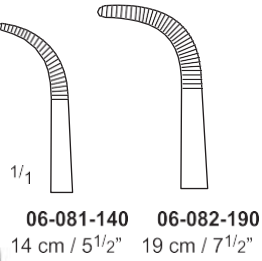

MIXTER BABY  
 06-082-190  
 19 cm / 7 1/2"

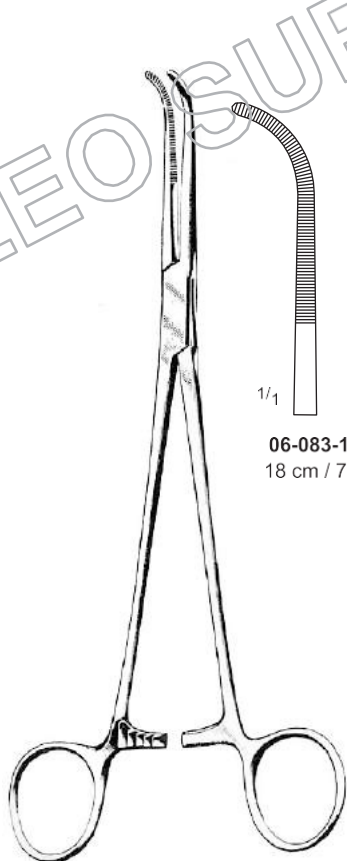

MIXTER

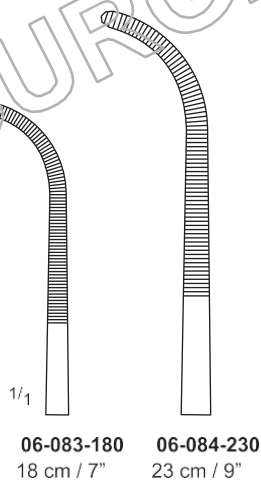

WICKSTROM

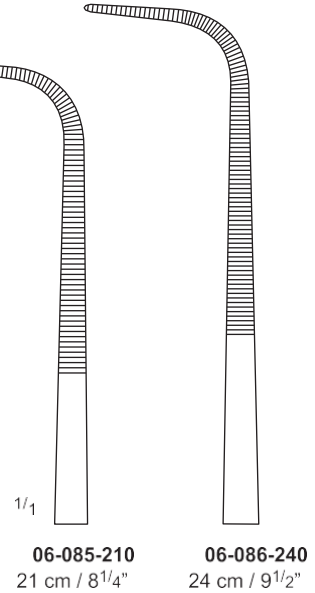

Artery Forceps, Dissecting and Ligature Forceps, Bronchus and Gall Duct Clamps

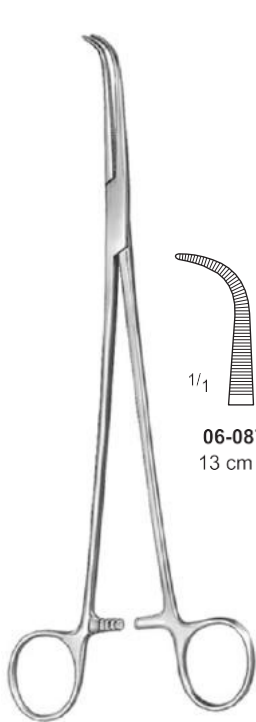

GEMINI

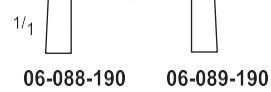
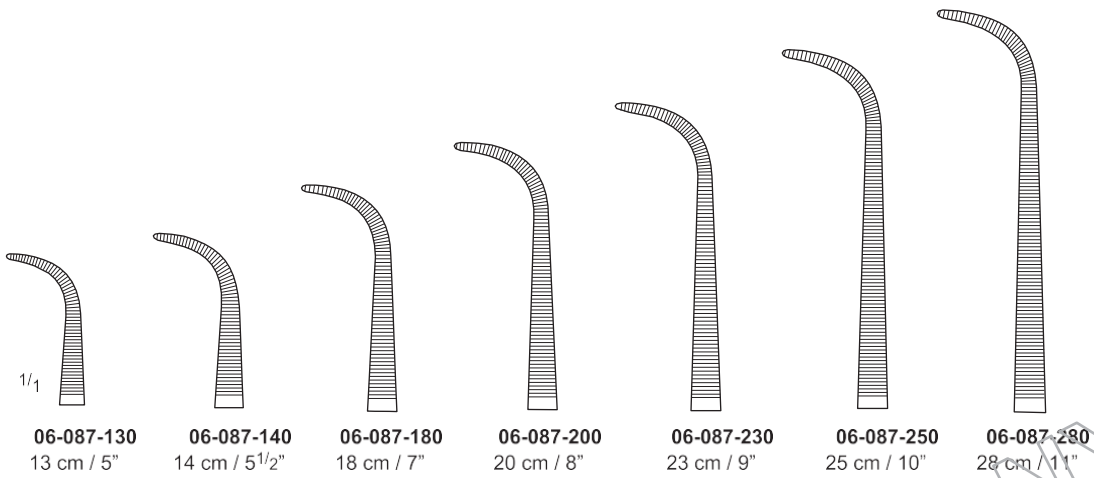

Tonsil Seizing  
 Forceps



SCHNIDT  
 19 cm / 7 1/2"

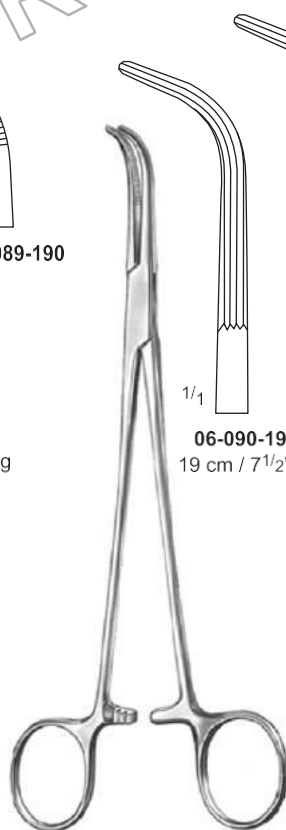

LAHEY

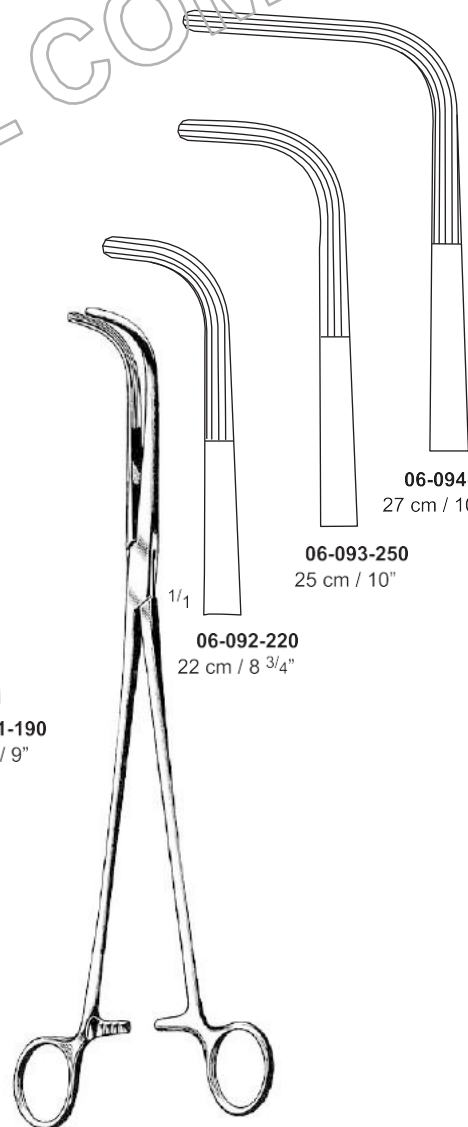
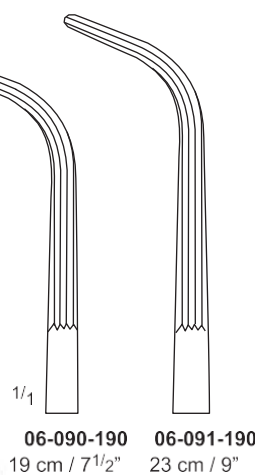

MIXTER

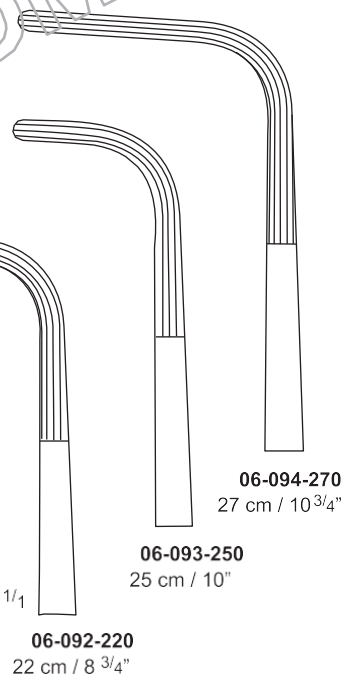

LEO SURGICAL COMPANY

Tissue and Organ Holding Forceps

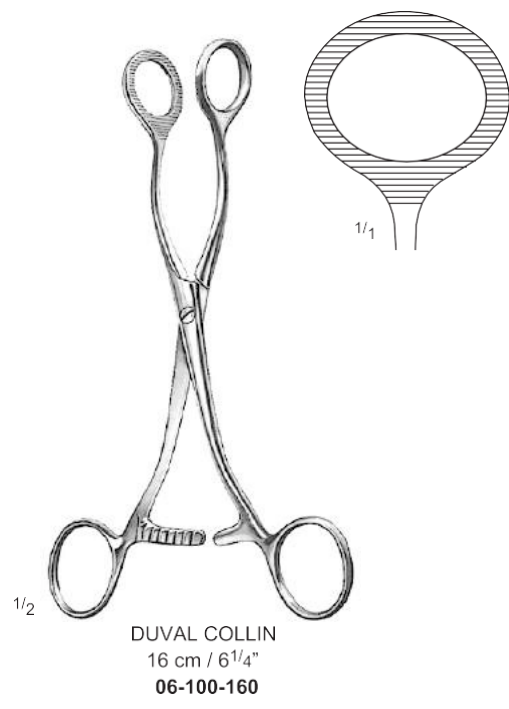
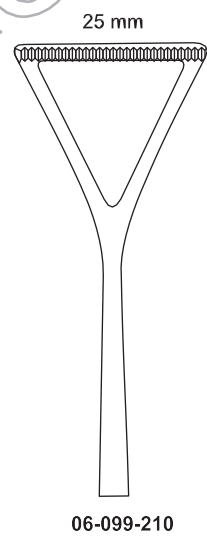
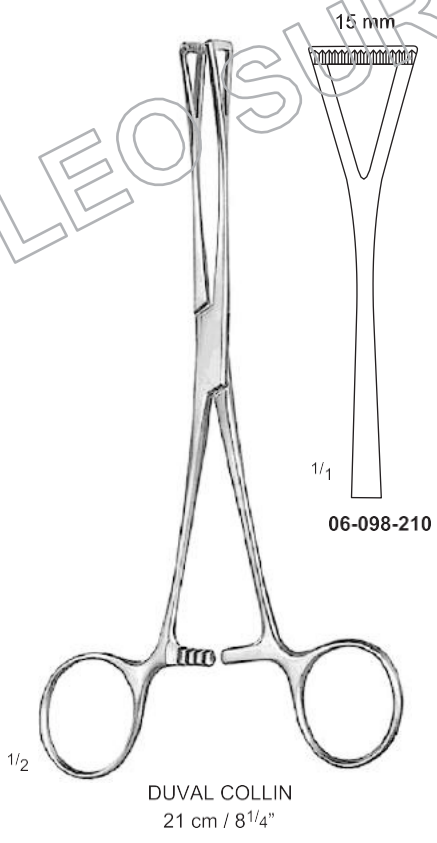
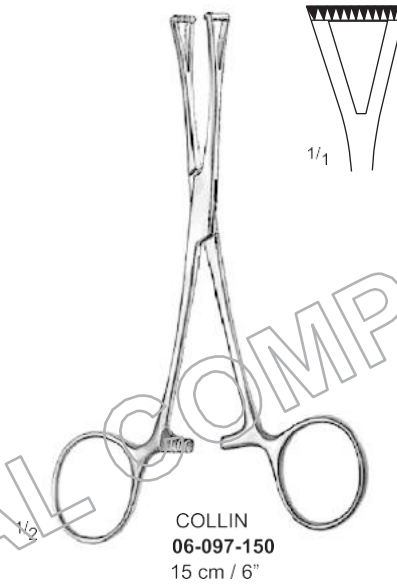
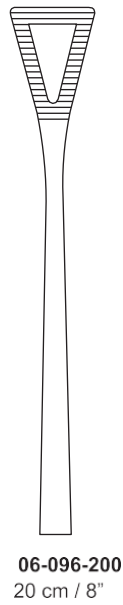
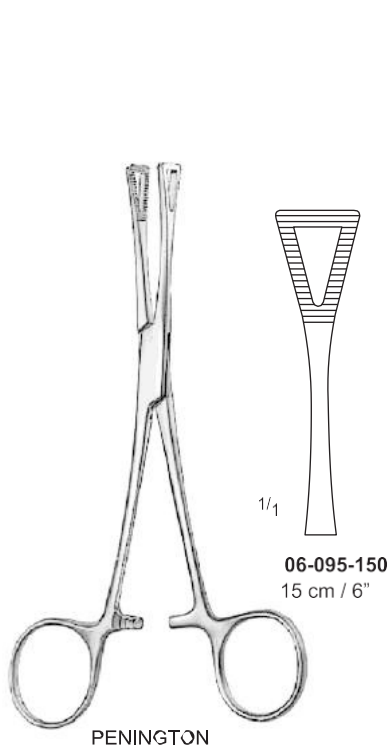

LEO SURGICAL COMPANY

Towel Clamps



JONES  
06-101-090  
9 cm / 3 1/2"



SCHAEDEL  
06-102-090  
9 cm / 3 1/2"



BACKHAUS  
06-103-085 – 8.5 cm / 3 1/4"  
06-103-105 – 10.5 cm / 4 1/4"  
06-106-130 – 13 cm / 5"  
06-106-150 – 15 cm / 6"



BACKHAUS-ROEDER  
06-107-130 – 13 cm / 5"  
06-107-150 – 15 cm / 6"



BALL & SOCKET  
06-108-130 – 13 cm / 5"  
06-108-150 – 15 cm / 6"



LANE  
06-109-150 – 15 cm / 6"  
06-109-180 – 18 cm / 7"  
06-109-200 – 20 cm / 8"

Tubing Clamps

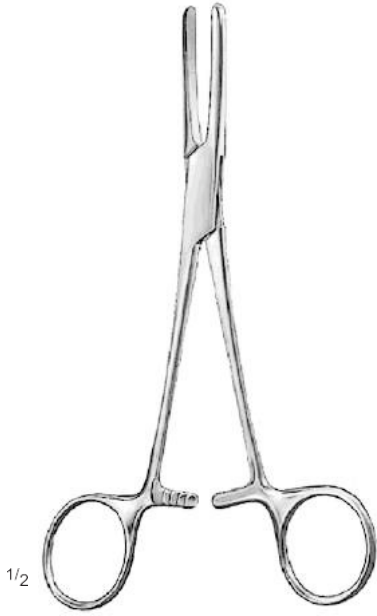

PRESBYTARIAN HOSPITAL



06-110-160  
 16 cm / 6 1/4"



06-110-180  
 18 cm / 7"



06-110-200  
 20 cm / 8"



SCHOENBERG

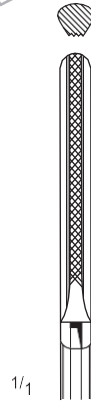

06-111-160  
 16 cm / 6 1/4"

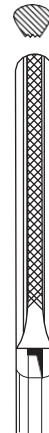

06-111-180  
 18 cm / 7"



06-111-200  
 20 cm / 8"

LEO SURGICAL COMPANY

# Needle Holder & Sutures



Needle Holders, with Tungsten Carbide T/C Inserts

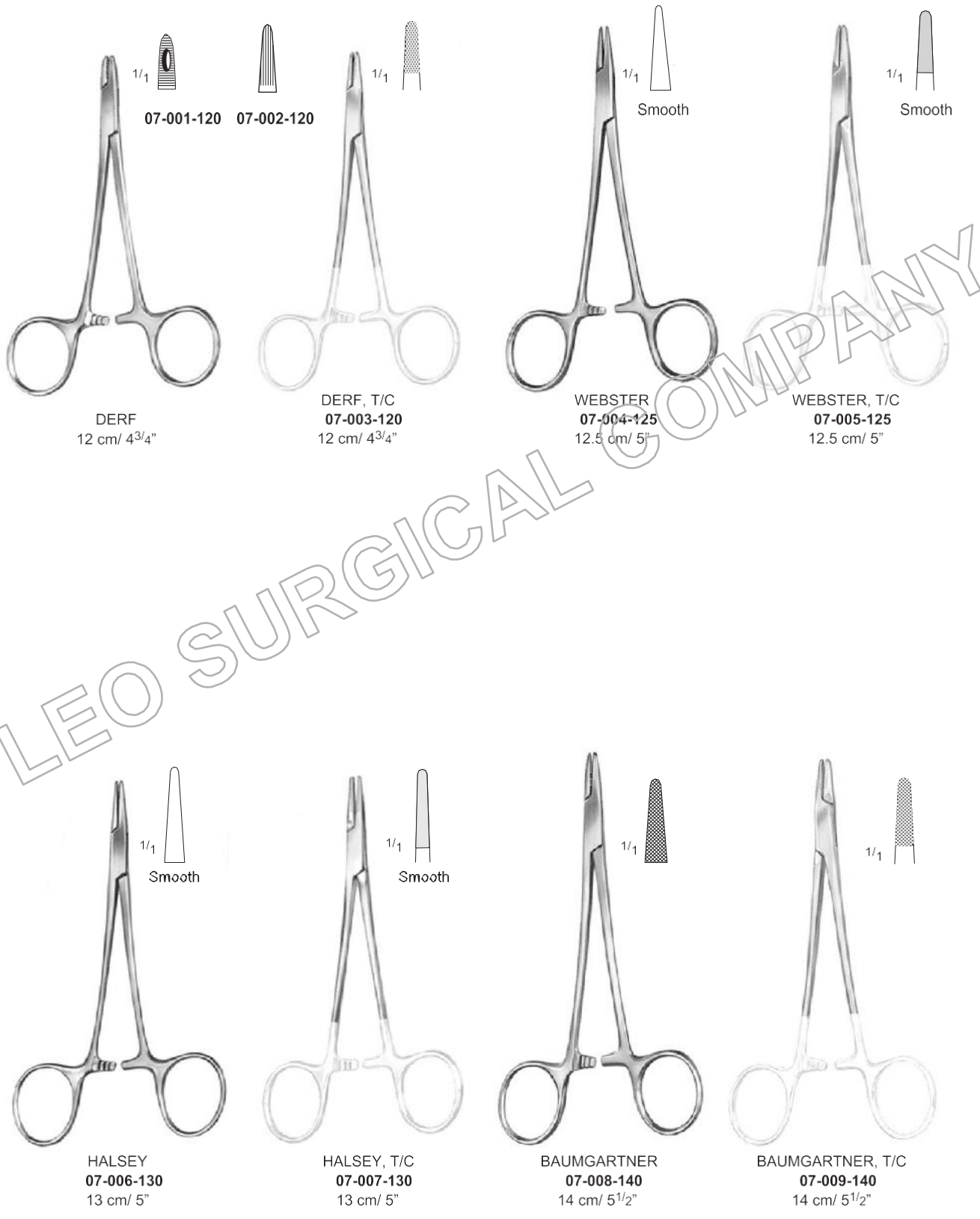

DERF  
 12 cm/ 4<sup>3</sup>/<sub>4</sub>"

07-001-120 07-002-120

DERF, T/C  
 07-003-120  
 12 cm/ 4<sup>3</sup>/<sub>4</sub>"

WEBSTER  
 07-004-125  
 12.5 cm/ 5"

Smooth

WEBSTER, T/C  
 07-005-125  
 12.5 cm/ 5"

Smooth

HALSEY  
 07-006-130  
 13 cm/ 5"

Smooth

HALSEY, T/C  
 07-007-130  
 13 cm/ 5"

Smooth

BAUMGARTNER  
 07-008-140  
 14 cm/ 5<sup>1</sup>/<sub>2</sub>"

1/1

BAUMGARTNER, T/C  
 07-009-140  
 14 cm/ 5<sup>1</sup>/<sub>2</sub>"

1/1



Needle Holders, with Tungsten Carbide T/C Inserts

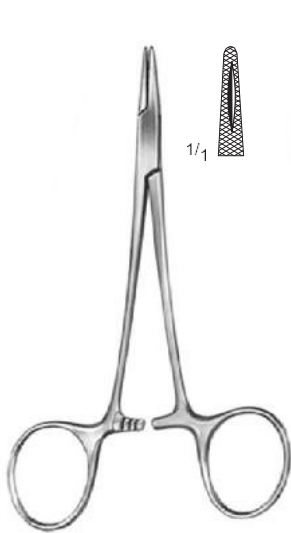

WRIGHT (DERF)  
**07-010-125**  
 12.5 cm / 5"

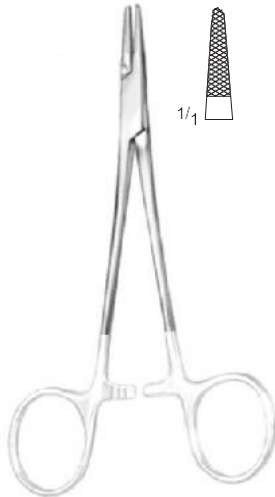

WRIGHT (DERF), T/C  
**07-011-125**  
 12.5 cm / 5"

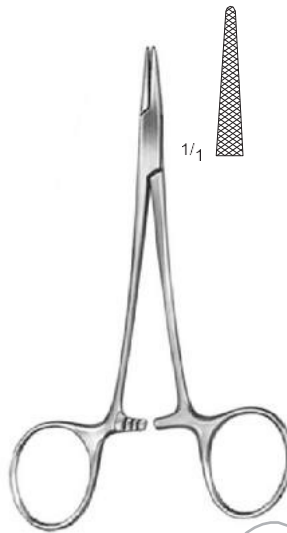

HALSEY  
**07-012-135**  
 13.5 cm / 5 1/4"

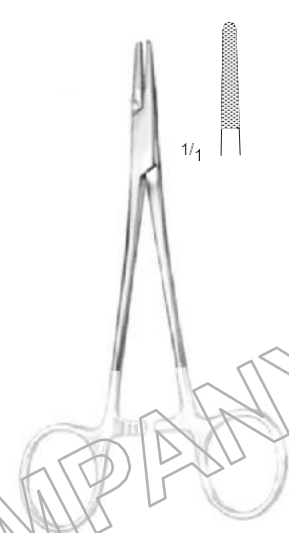

HALSEY, T/C  
**07-013-135**  
 13.5 cm / 5 1/4"

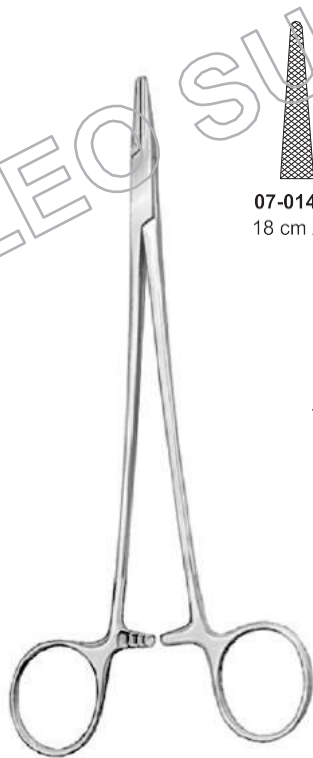

CRILE WOOD

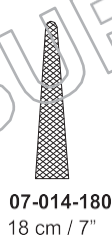

**07-014-180**  
 18 cm / 7"

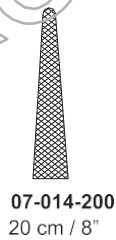

**07-014-200**  
 20 cm / 8"

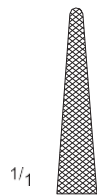

**07-014-230**  
 23 cm / 9"



CRILE WOOD, T/C  
 (DEBAKEY)



**07-015-180**  
 18 cm / 7"



**07-015-200**  
 20 cm / 8"



**07-015-230**  
 23 cm / 9"



**07-015-250**  
 25 cm / 10"



**07-015-300**  
 30 cm / 12"

Needle Holders, with Tungsten Carbide T/C Inserts



MAYO HEGAR

1/1



**07-016-150**  
15 cm/ 6"



**07-016-180**  
18 cm/ 7"



**07-016-200**  
20 cm/ 8"



**07-016-240**  
24 cm/ 9 1/2"



**07-016-260**  
26 cm/ 10 1/4"



**07-016-300**  
30 cm/ 12"

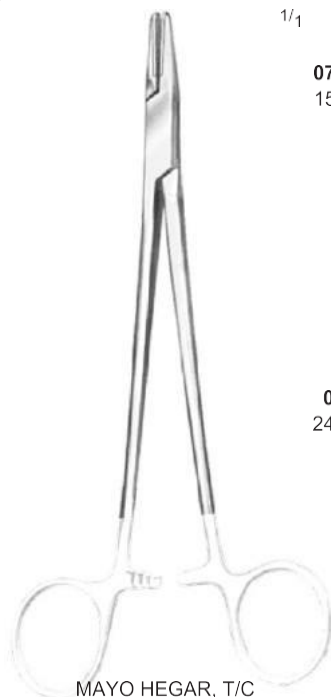

MAYO HEGAR, T/C

1/1



**07-017-150**  
15 cm/ 6"



**07-017-180**  
18 cm/ 7"



**07-017-200**  
20 cm/ 8"



**07-017-240**  
24 cm/ 9 1/2"



**07-017-260**  
26 cm/ 10 1/4"



**07-017-300**  
30 cm/ 12"

LEO SURGICAL COMPANY

Needle Holders, with Tungsten Carbide T/C Inserts



CRILE MURRAY  
 07-018-150  
 15 cm / 6"



Grooved Jaws



CRILE WOOD  
 07-019-150  
 15 cm / 6"



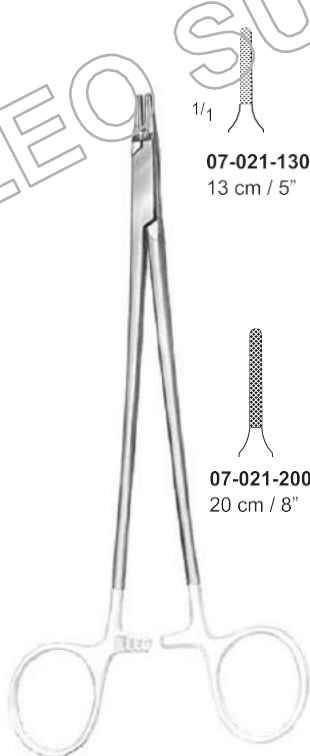

CRILE WOOD, T/C  
 07-020-150  
 15 cm / 6"









RYDER (FRENCH EYE), T/C

- 1/1  **07-021-130**  
13 cm / 5"
-  **07-021-150**  
15 cm / 6"
-  **07-021-180**  
18 cm / 7"

-  **07-021-200**  
20 cm / 8"
-  **07-021-230**  
23 cm / 9"
-  **07-021-250**  
25 cm / 10"



RYDER (VASCULAR), T/C

- 1/1  **07-022-130**  
13 cm / 5"
-  **07-022-150**  
15 cm / 6"
-  **07-022-180**  
18 cm / 7"
-  **07-022-200**  
20 cm / 8"
-  **07-022-230**  
23 cm / 9"
-  **07-022-260**  
26 cm / 10"

LEO SURGICAL COMPANY

Needle Holders, with Tungsten Carbide T/C Inserts

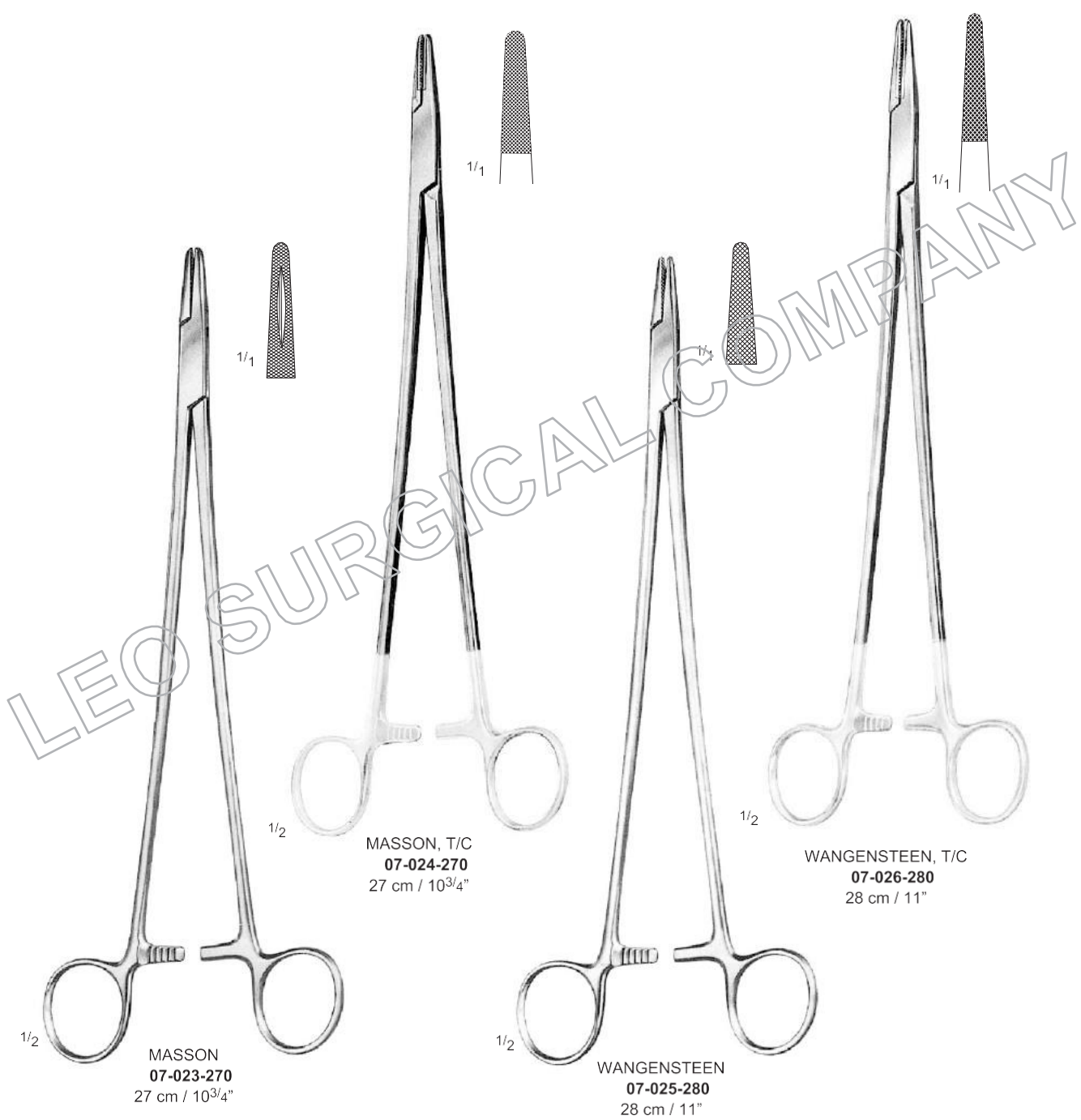

Needle Holders, with Tungsten Carbide T/C Inserts

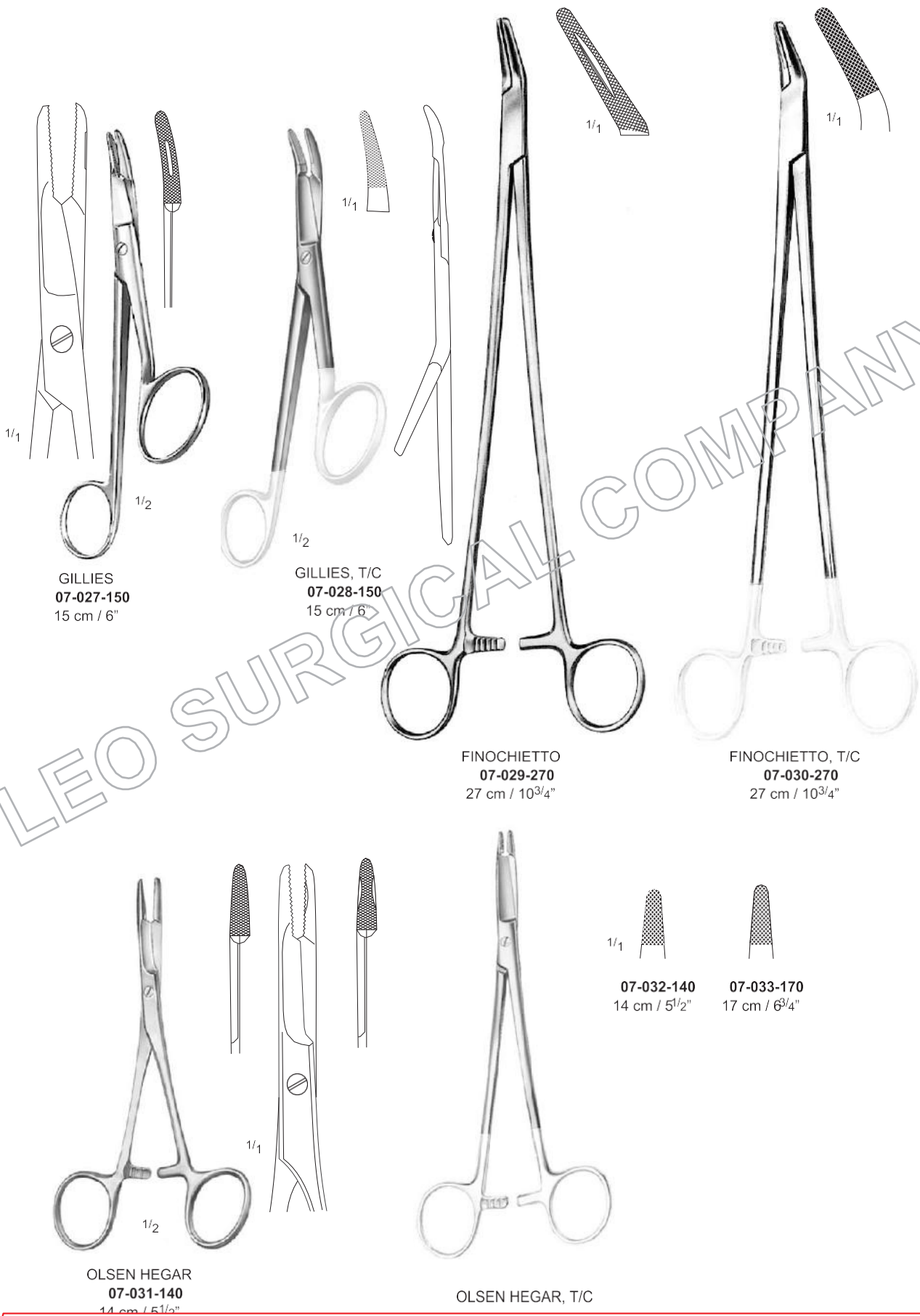

LEO SURGICAL COMPANY

Needle Holders, with Tungsten Carbide T/C Inserts



1/1  
**07-034-140** **07-034-170**  
 14 cm / 5 1/2" 17 cm / 6 3/4"

MATHIEU KOCHER  
 09. 65.14 – 09. 65.17



1/1  
**07-035-140** **07-035-170** **07-035-200**  
 14 cm / 5 1/2" 17 cm / 6 3/4" 20 cm / 8"

MATHIEU KOCHER, T/C  
 09. 66.14 – 09. 66.20



1/1  
**07-036-140** **07-036-170** **07-036-200**  
 14 cm / 5 1/2" 17 cm / 6 3/4" 20 cm / 8"

MATHIEU  
 09. 67.14 – 09. 67.20



1/1  
**07-037-140** **07-037-170** **07-037-200**  
 14 cm / 5 1/2" 17 cm / 6 3/4" 20 cm / 8"

MATHIEU



1/1  
**07-038-140** **07-038-170** **07-038-200**  
 14 cm / 5 1/2" 17 cm / 6 3/4" 20 cm / 8"

MATHIEU, T/C



1/1  
**07-039-170** **07-039-200**  
 17 cm / 6 3/4" 20 cm / 8"

MATHIEU T/ C

Micro Needle Holders, with Tungsten Carbide T/C Inserts



CASTROVIEJO - STANDARD  
 14 cm / 5 1/2"



CASTROVIEJO - STANDARD  
 14 cm / 5 1/2"

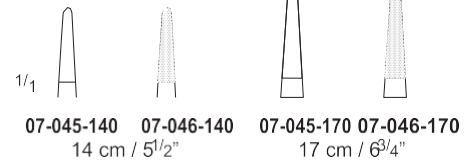

CASTROVIEJO  
 (JACOBSON) T/C

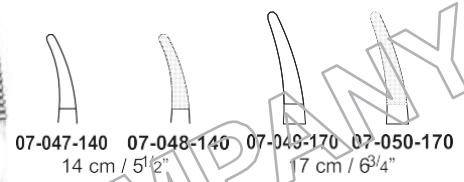

LEO SURGICAL COMPANY

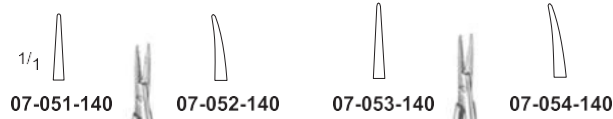

CASTROVIEJO - MICRO  
 14 cm / 5 1/2"



CASTROVIEJO - MICRO  
 14 cm / 5 1/2"

Ligature Needles

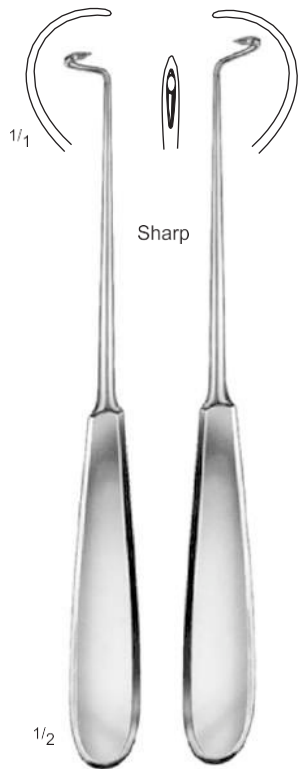

DESCHAMPS - BABY  
07-055-200 07-056-200  
20 cm / 8"

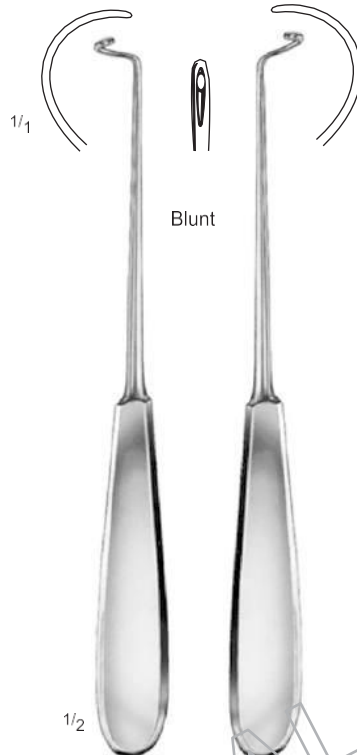

DESCHAMPS - BABY  
07-057-200 07-058-200  
20 cm / 8"

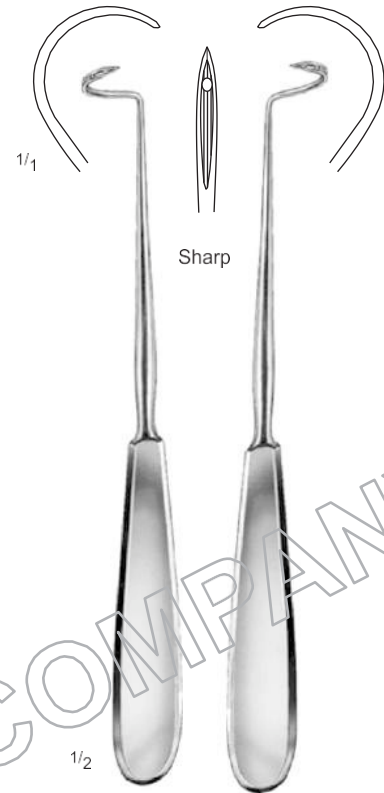

DESCHAMPS - BABY  
07-059-200 07-060-200  
20 cm / 8"

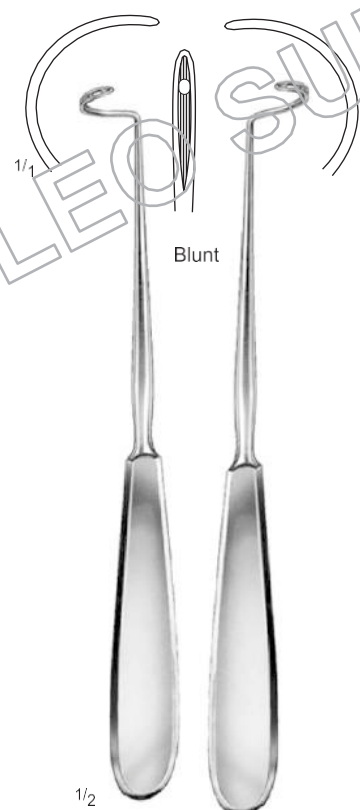

DESCHAMPS  
07-061-200 07-062-200  
20 cm / 8"

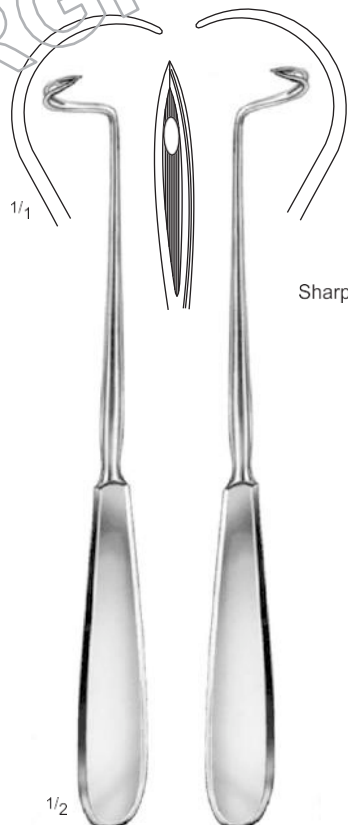

DESCHAMPS  
07-063-200 07-064-200  
20 cm / 8"

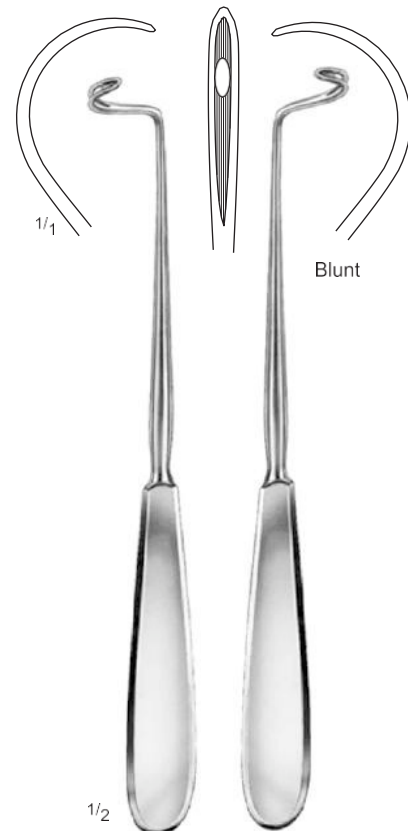

DESCHAMPS  
07-065-200 07-066-200  
20 cm / 8"



Ligature Needles



Reverdin Needles

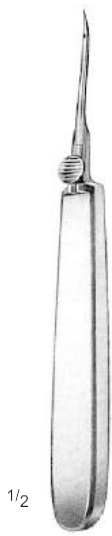

REVERDIN  
010. 07.14 – 010. 07.17  
14 cm / 5 1/2"



07-073-001  
# 1

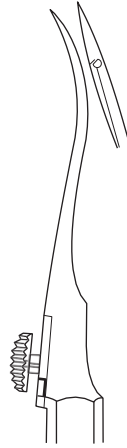

07-073-002  
# 2



07-073-003  
# 3

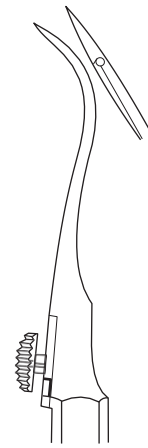

07-073-004  
# 4

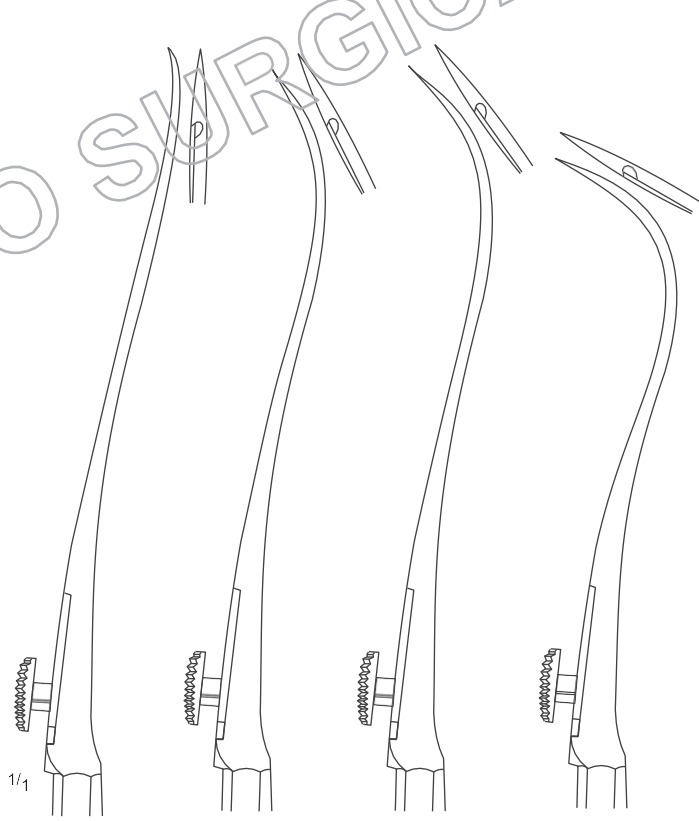

07-074-225

07-075-225

07-076-225

07-077-225



REVERDIN  
22.5 cm / 8 3/4"

LEO SURGICAL COMPANY

Clip Applying and Removing Forceps, Ligature Scissors



1/2

**MICHEL**  
**07-078-125**  
12.5 cm / 5"



1/2

**HEGENBARTH**  
**07-079-120**  
12 cm / 4 3/4"



1/2

**MICHEL**  
**07-080-120**  
12 cm / 4 3/4"



1/2

**COLLIN**  
**07-081-130**  
13 cm / 5"

LEO SURGICAL COMPANY

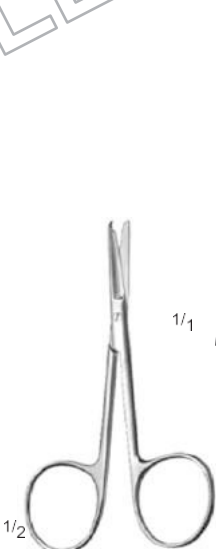

1/2

**SPENCER**  
**07-082-090**  
9 cm / 3 1/2"

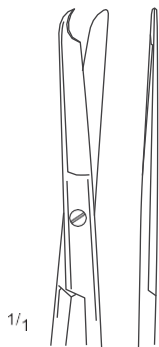

1/4

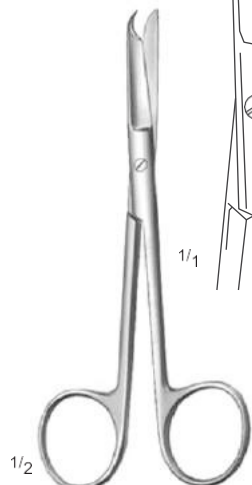

1/2

**SPENCER**  
**07-083-105** – 10.5 cm / 4"  
**07-083-120** – 12 cm / 4 3/4"  
**07-083-140** – 14 cm / 5 3/4"

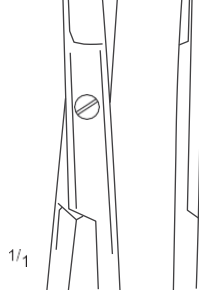

1/4

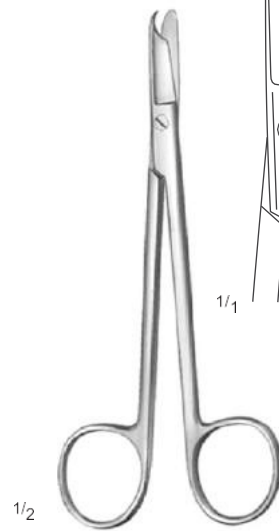

1/2

**LITTAUER**  
**07-084-130**  
13 cm / 5"

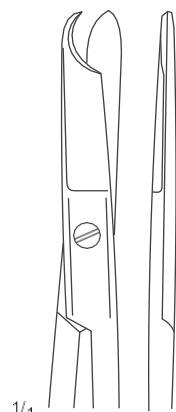

1/4

Wire Cutting Scissors

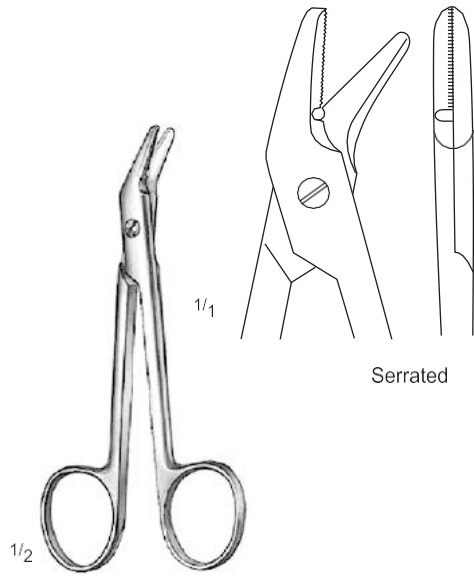

UNIVERSAL  
07-085-120  
12 cm / 4<sup>3</sup>/<sub>4</sub>"

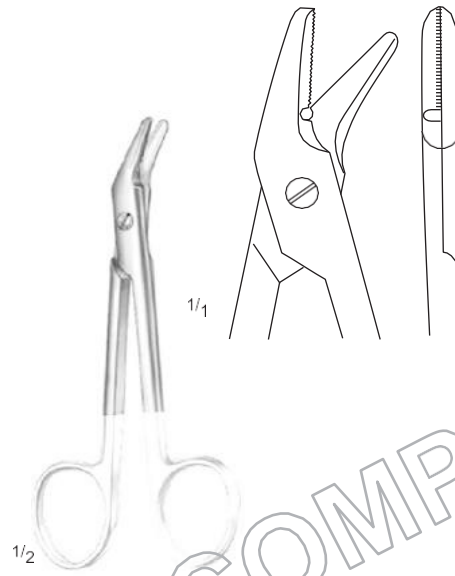

UNIVERSAL, T/C  
07-086-120  
12 cm / 4<sup>3</sup>/<sub>4</sub>"

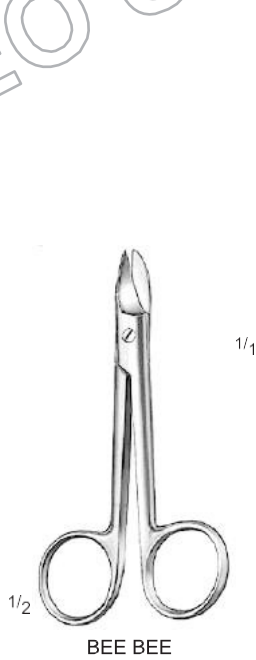

BEE BEE

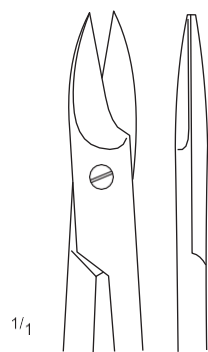

07-087-105  
10.5 cm / 4<sup>1</sup>/<sub>8</sub>"

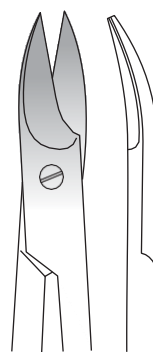

07-088-105  
10.5 cm / 4<sup>1</sup>/<sub>8</sub>"

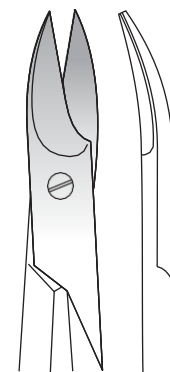

07-089-105  
10.5 cm / 4<sup>1</sup>/<sub>8</sub>"  
one blade serrated

LEO SURGICAL COMPANY

# Bandage & Plaster

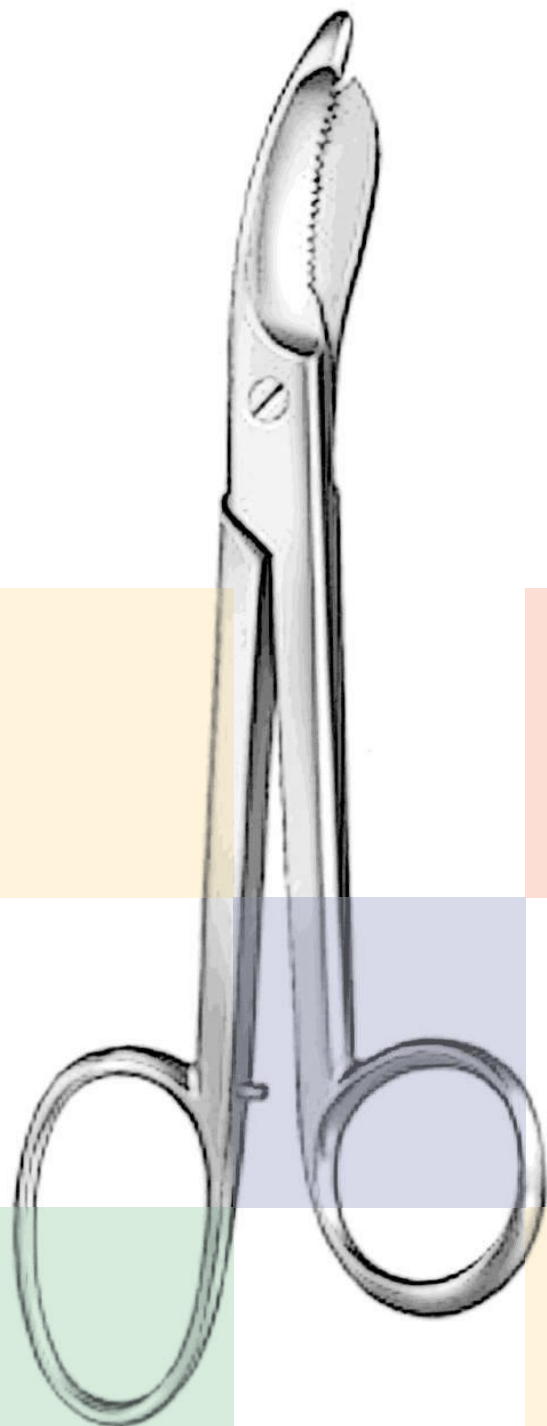

Bandage Scissors, Plaster Shears

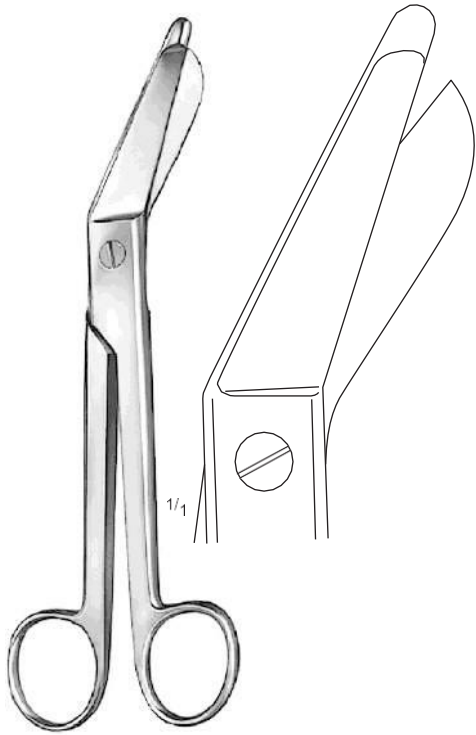

ESMARCH  
 08-001-120 20 cm / 8"  
 08-001-220 – 22 cm / 8<sup>3</sup>/<sub>4</sub>"

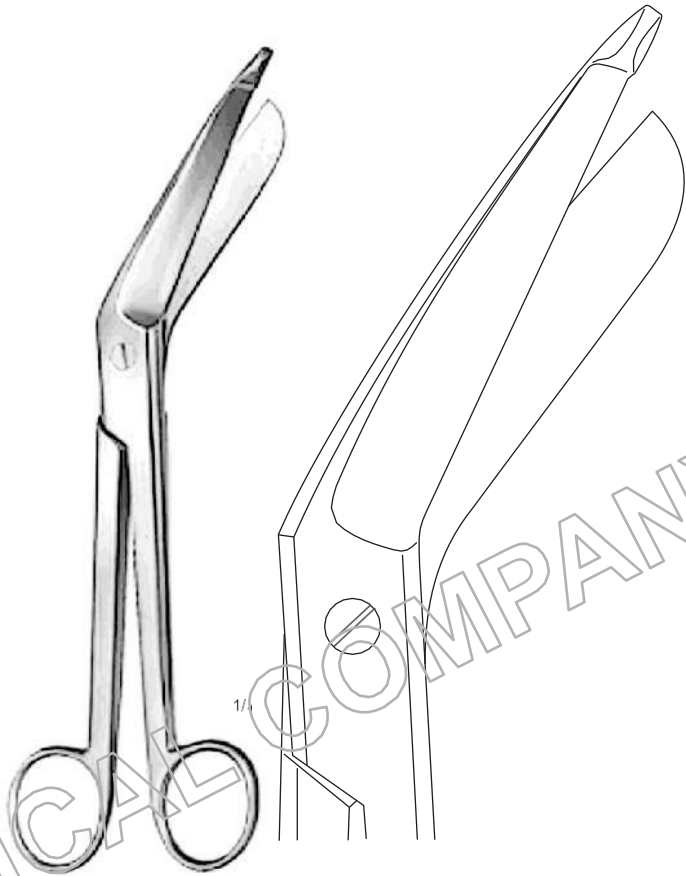

ESMARCH  
 08-002-230  
 23 cm / 4"

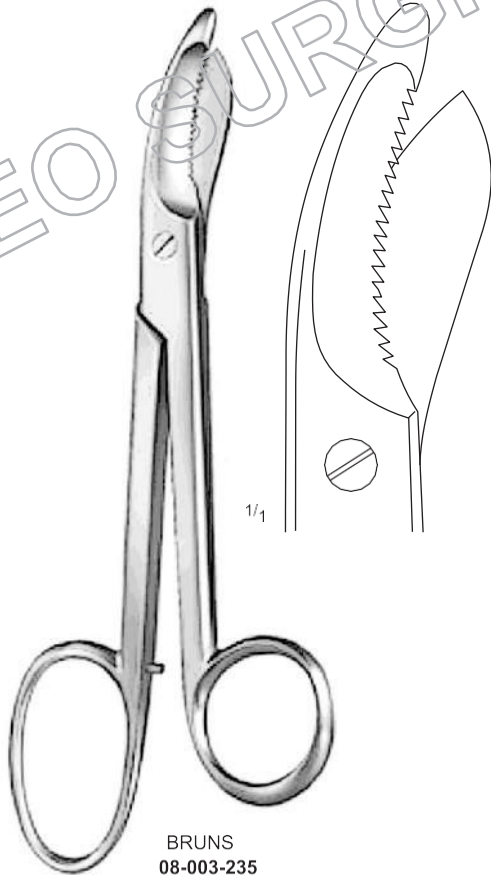

BRUNS  
 08-003-235  
 23.5 cm / 9<sup>1</sup>/<sub>4</sub>"



UNIVERSAL  
 08-004-150 – 15 cm / 6"  
 08-004-180 – 18 cm / 7"  
 (Black Handle)  
 Other Colours Available

LEO SURGICAL COMPANY

Bandage Scissors, Plaster Shears

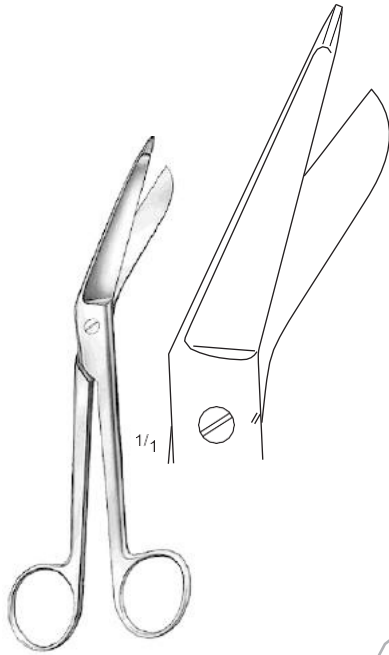

LISTER

- 08-005-115 – 11.5 cm / 4 1/2"
- 08-005-140 – 14 cm / 5 1/2"
- 08-005-180 – 18 cm / 7"
- 08-005-200 – 20 cm / 8"

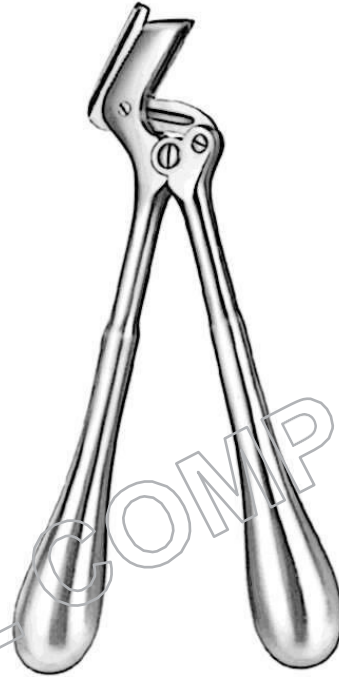

STILLE

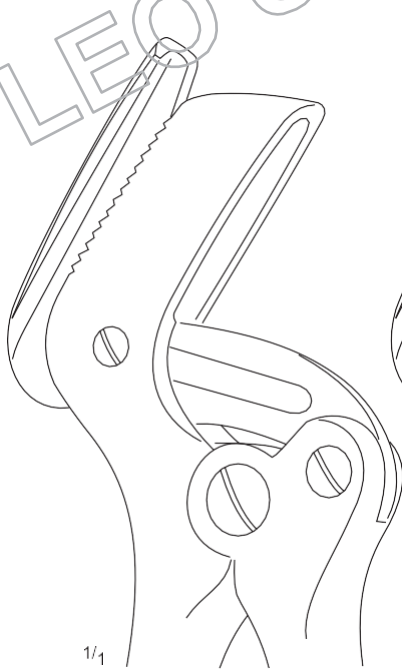

08-006-230  
 23 cm / 9"

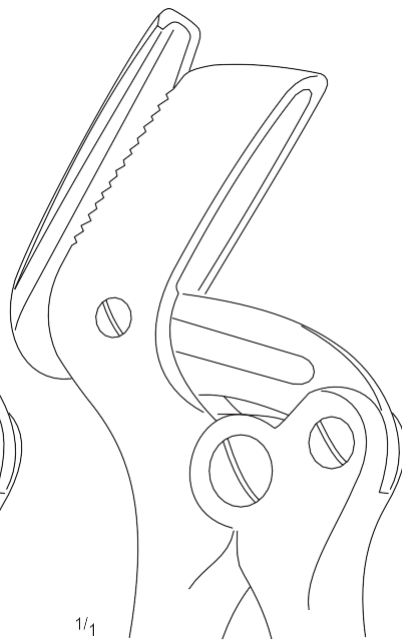

08-006-260  
 26 cm / 10 1/4"

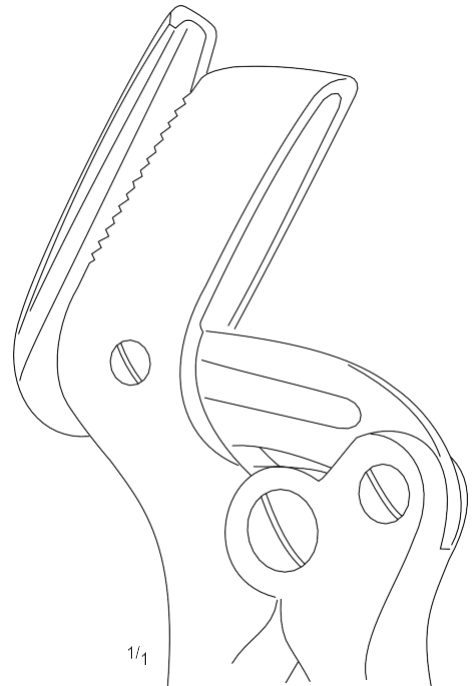

08-006-370  
 37 cm / 14 1/2"

Plaster Shears, Bandage Scissors, with Tungstun Carbide T/C Inserts

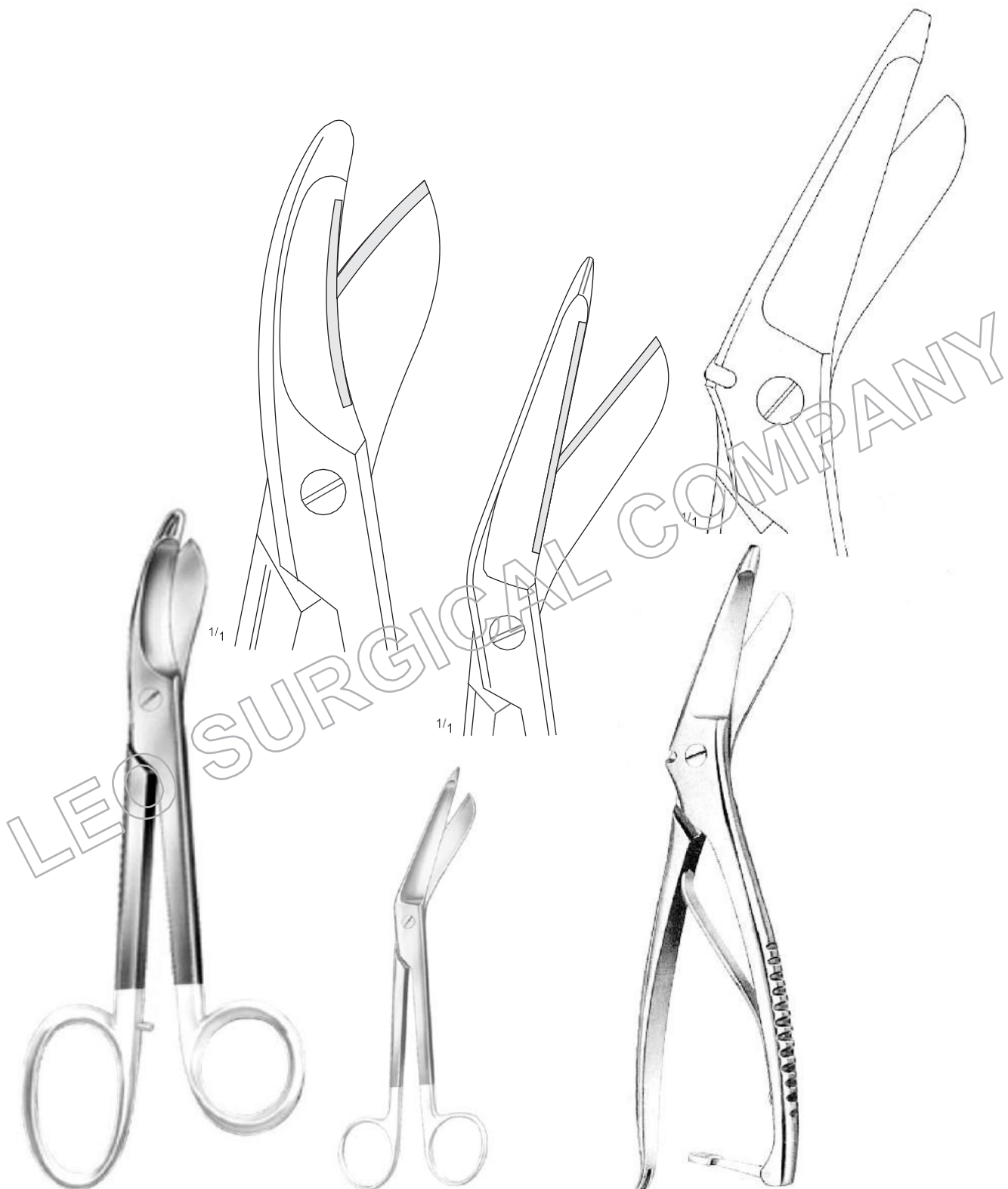

BRUNS, T/C  
08-007-235  
23.5 cm / 9<sup>1</sup>/<sub>4</sub>"

LISTER, T/C  
08-008-140 – 14 cm / 5<sup>1</sup>/<sub>2</sub>"  
08-008-180 – 18 cm / 7"

08-009-210  
21 cm / 8<sup>1</sup>/<sub>4</sub>"



Plaster Cast Bender Spreader

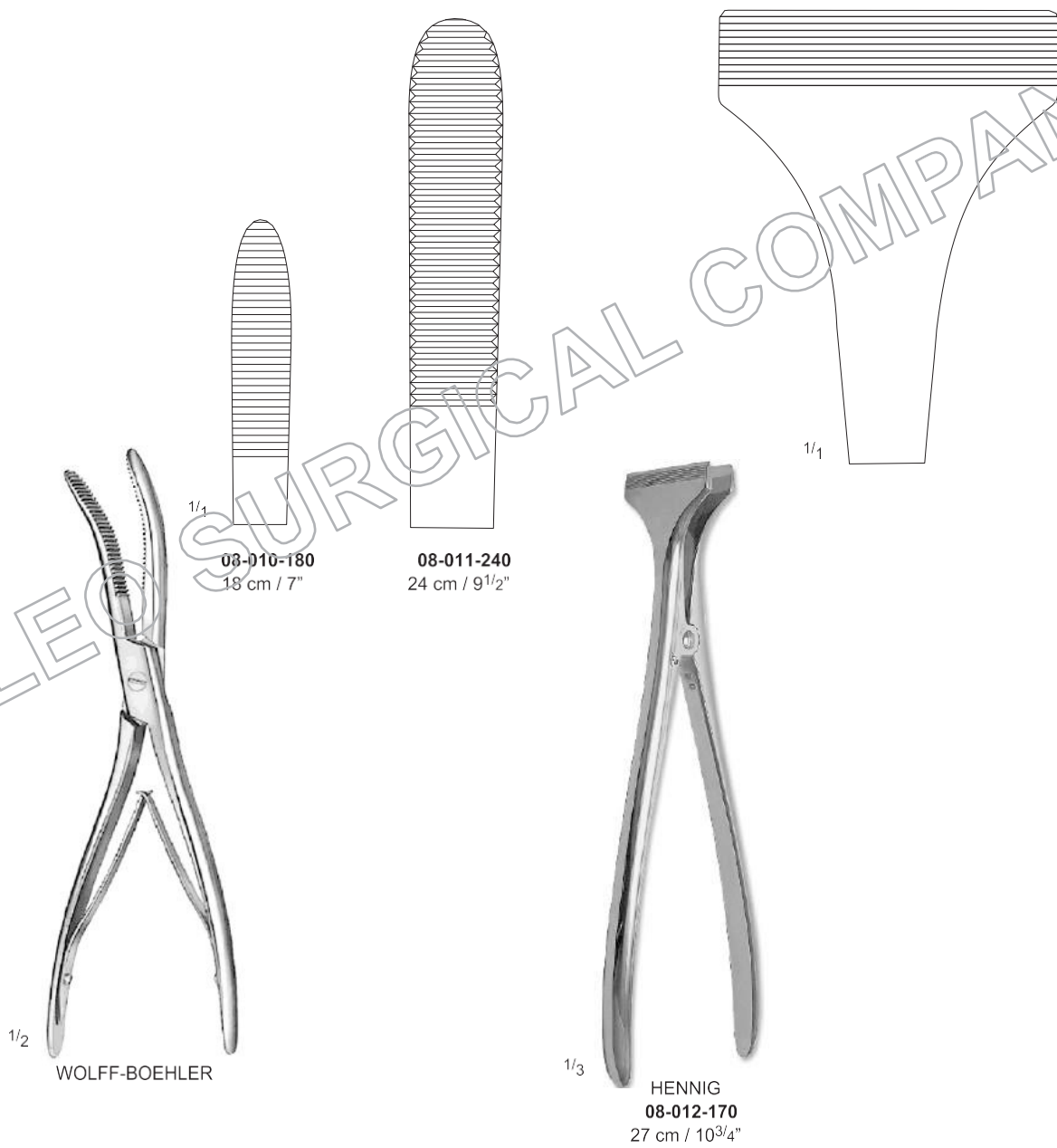

Plaster Cast Knives, Tube Gauze Applicators

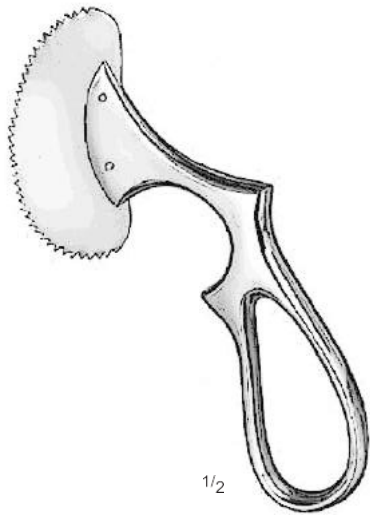

1/2

ENGEL  
08-013-150  
15 cm / 6"



1/2

ESMARCH  
08-014-180  
18 cm / 7"



1/2

HOPKINS  
08-015-200  
20 cm / 8"



1/2

REINER  
08-016-190  
19 cm / 7 1/2"

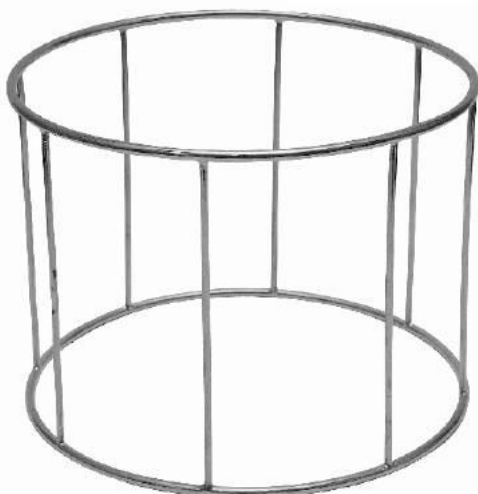

SIZE A  
08-017-000

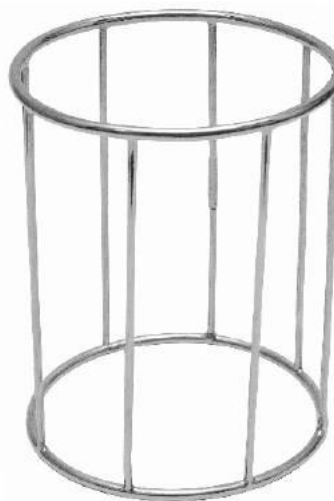

SIZE B  
08-018-000



SIZE C  
08-019-000



SIZE C  
08-020-000

# Intestinal Rectal

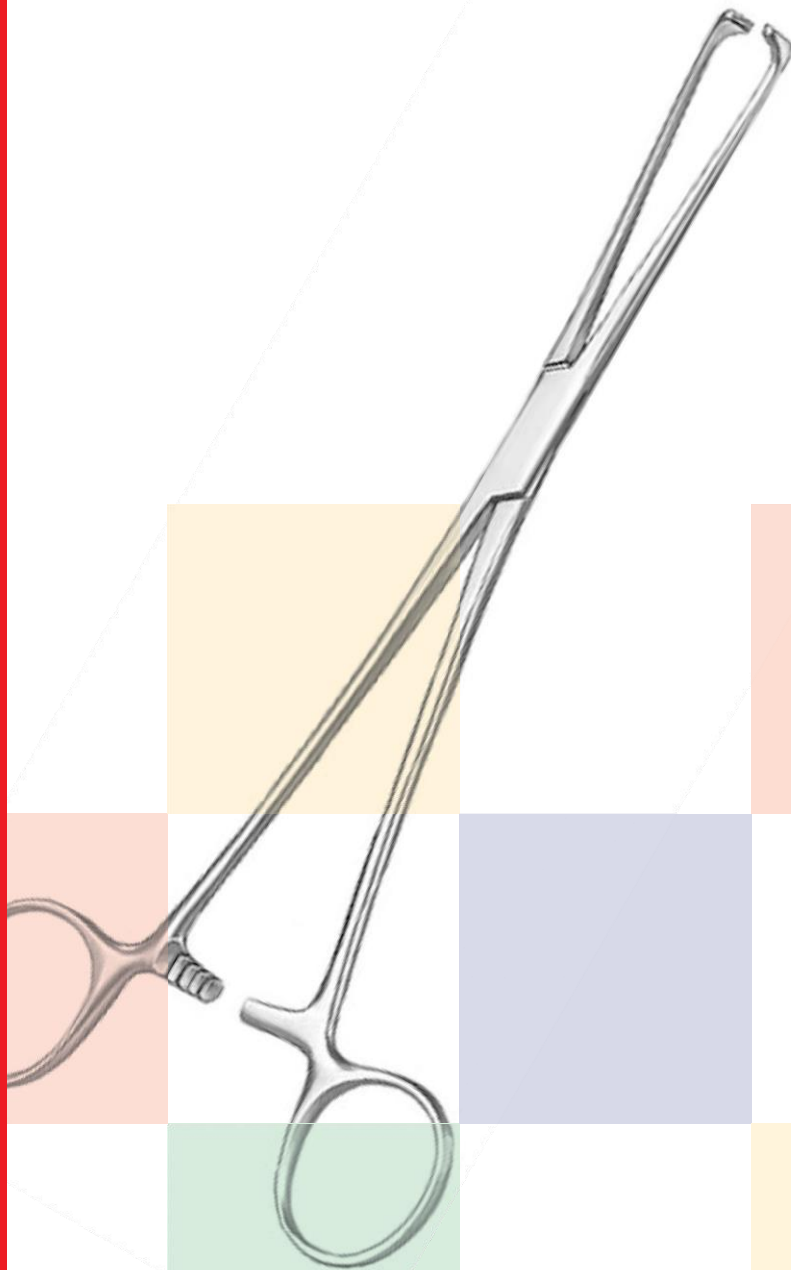

Tissue Holding Forceps

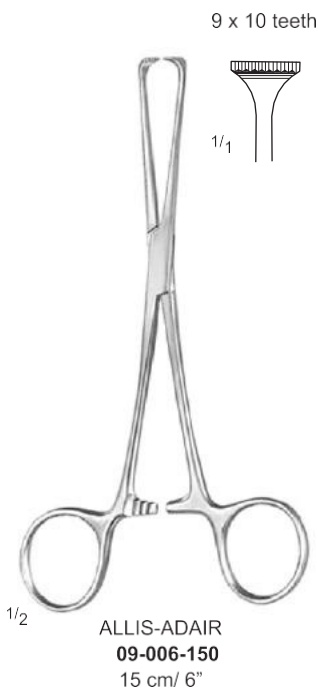
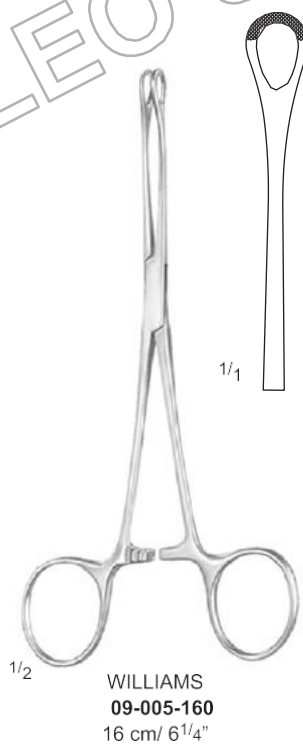
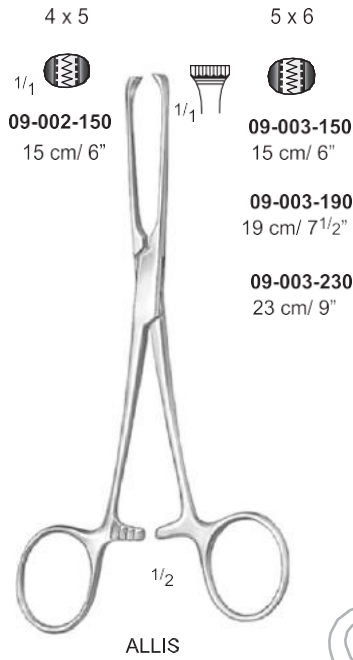

LEO SURGICAL COMPANY

Tissue Holding Forceps

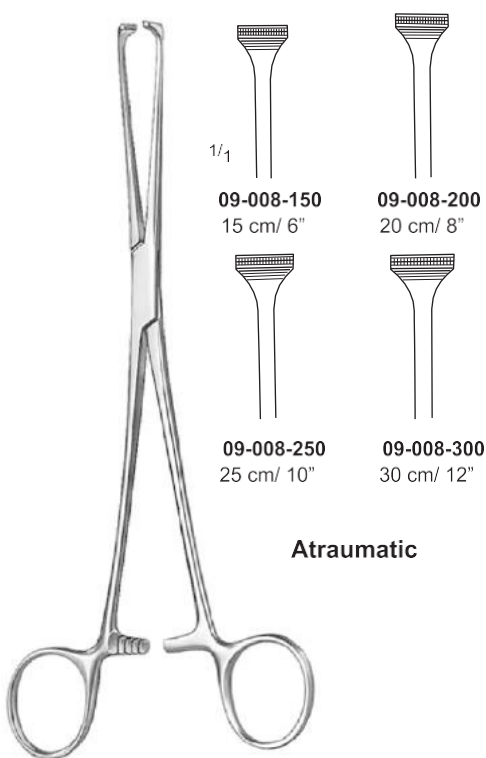

ALLIS ATRAUMA

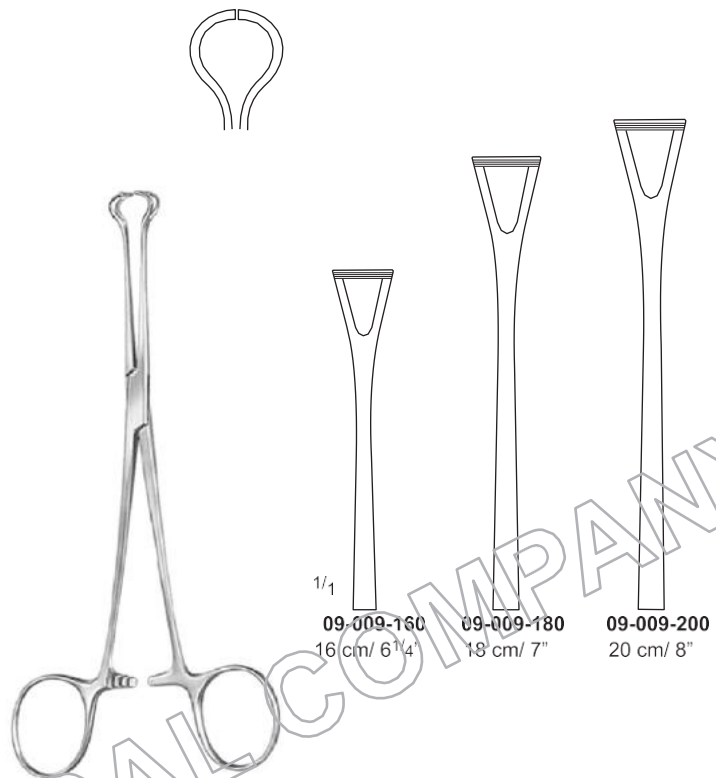

BABCOCK

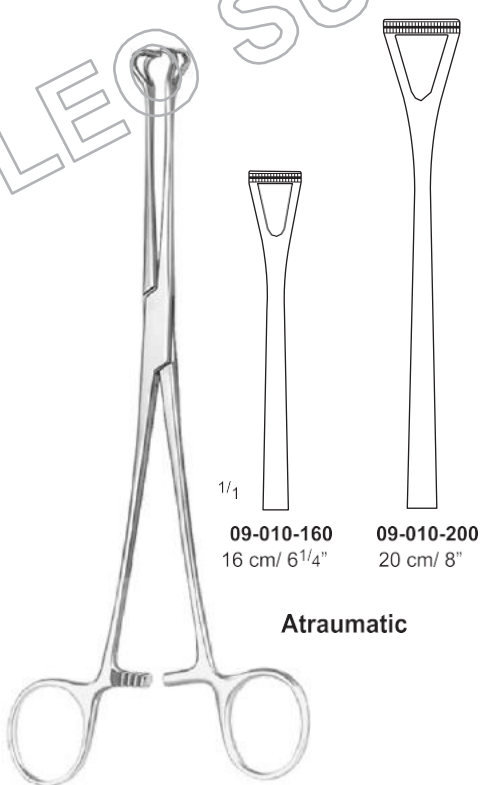

BABCOCK 'ATRAUMA'

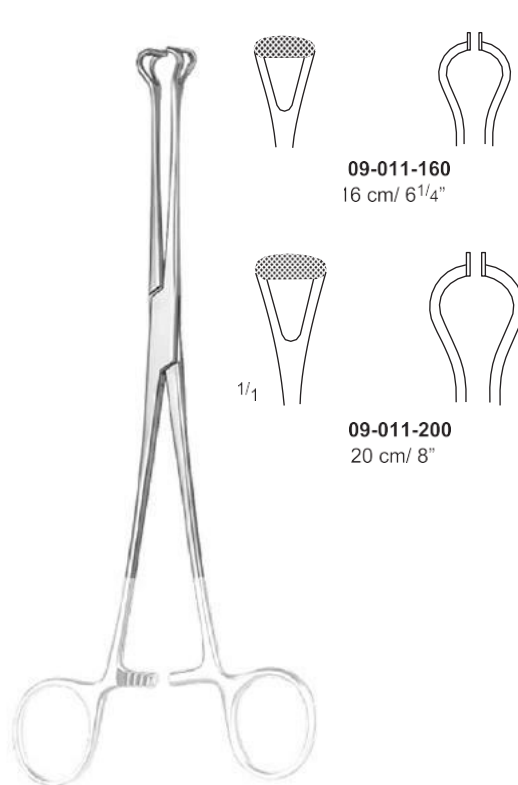

BABCOCK, T/C

Intestinal Clamp Forceps

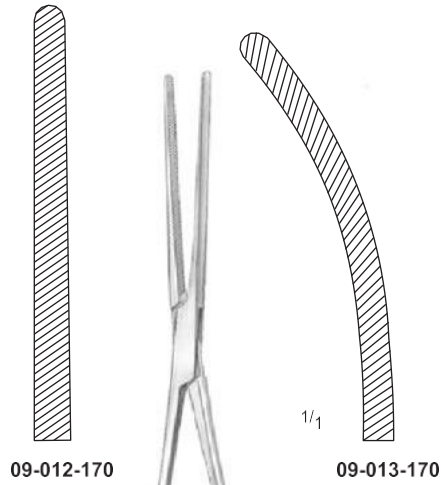

DOYEN BABY  
 17 cm / 6<sup>3</sup>/<sub>4</sub>"

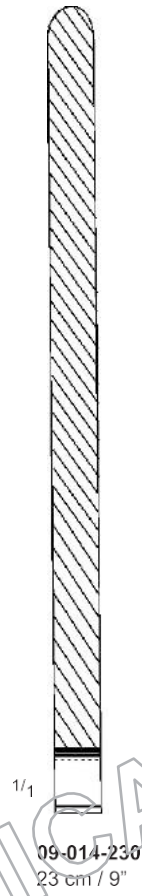

DOYEN  
 13. 24.23-PN.26.23

09-015-230  
 23 cm / 9"

Atraumatic

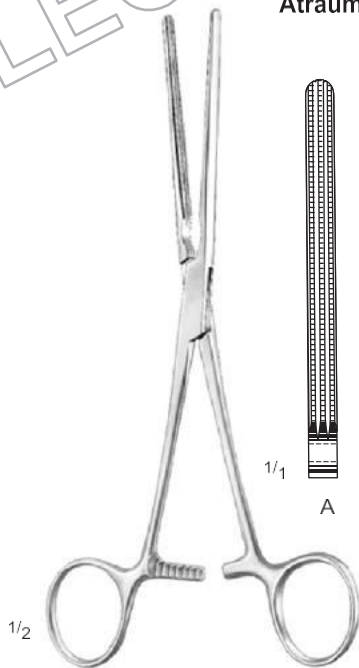

DOYEN ATRAUMA  
 13. 19.63-PN.19.70

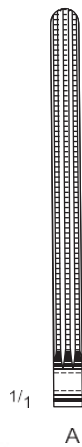

A



B

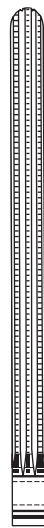

C

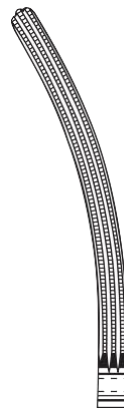

D

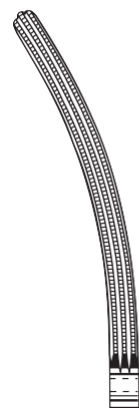

E

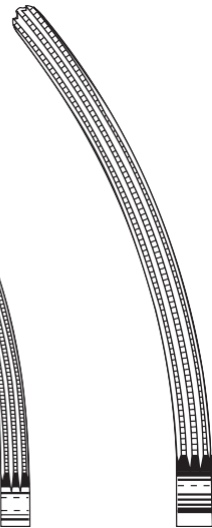

F

	13 cm / 5 <sup>1</sup> / <sub>4</sub> "	16 cm / 6 <sup>1</sup> / <sub>4</sub> "	18 cm / 7"
A.	09-016-130	B. 09-016-160	C. 09-016-180
D.	09-017-130	E. 09-017-160	F. 09-017-180

Intestinal Clamp Forceps



Atraumatic Clamp Forceps





Intestinal Clamp Forceps

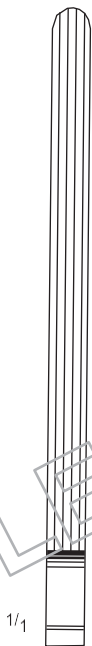

09-023-210  
 21 cm / 8<sup>1</sup>/<sub>4</sub>"

09-023-230  
 23 cm / 9"

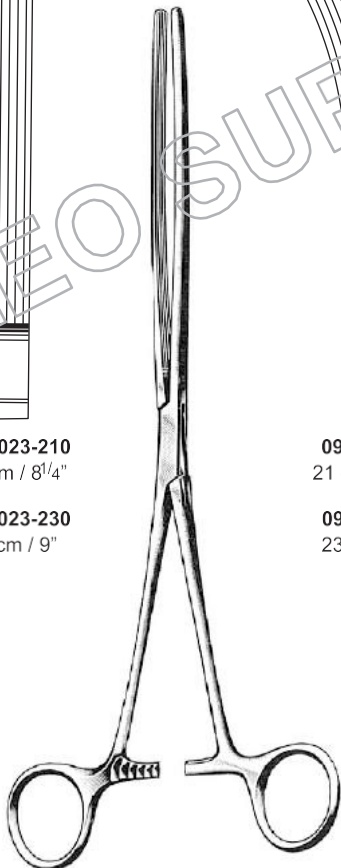

MAYO ROBSON



09-024-210  
 21 cm / 8<sup>1</sup>/<sub>4</sub>"

09-024-230  
 23 cm / 9"



09-025-250  
 25 cm / 10"

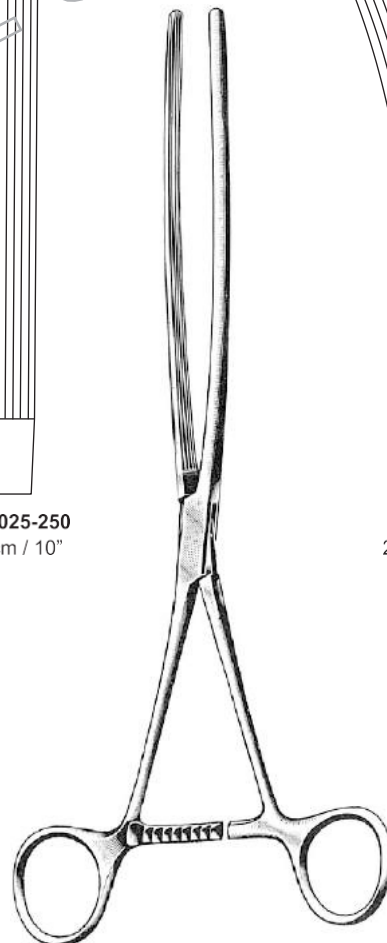

MAYO ROBSON

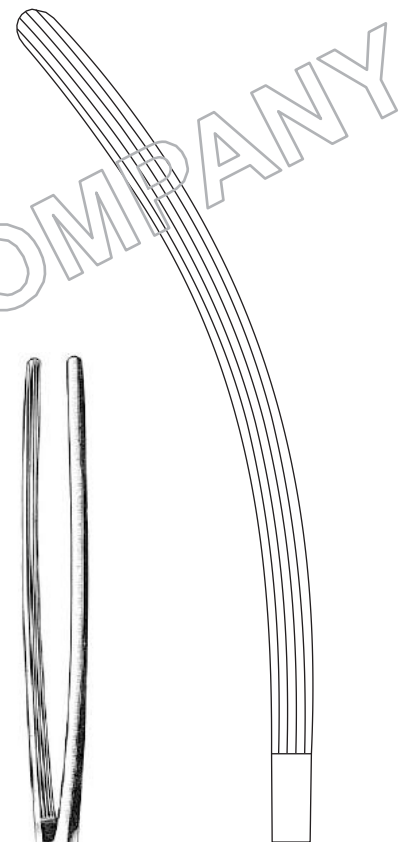

09-026-250  
 25 cm / 10"

Intestinal and Stomach Clamps

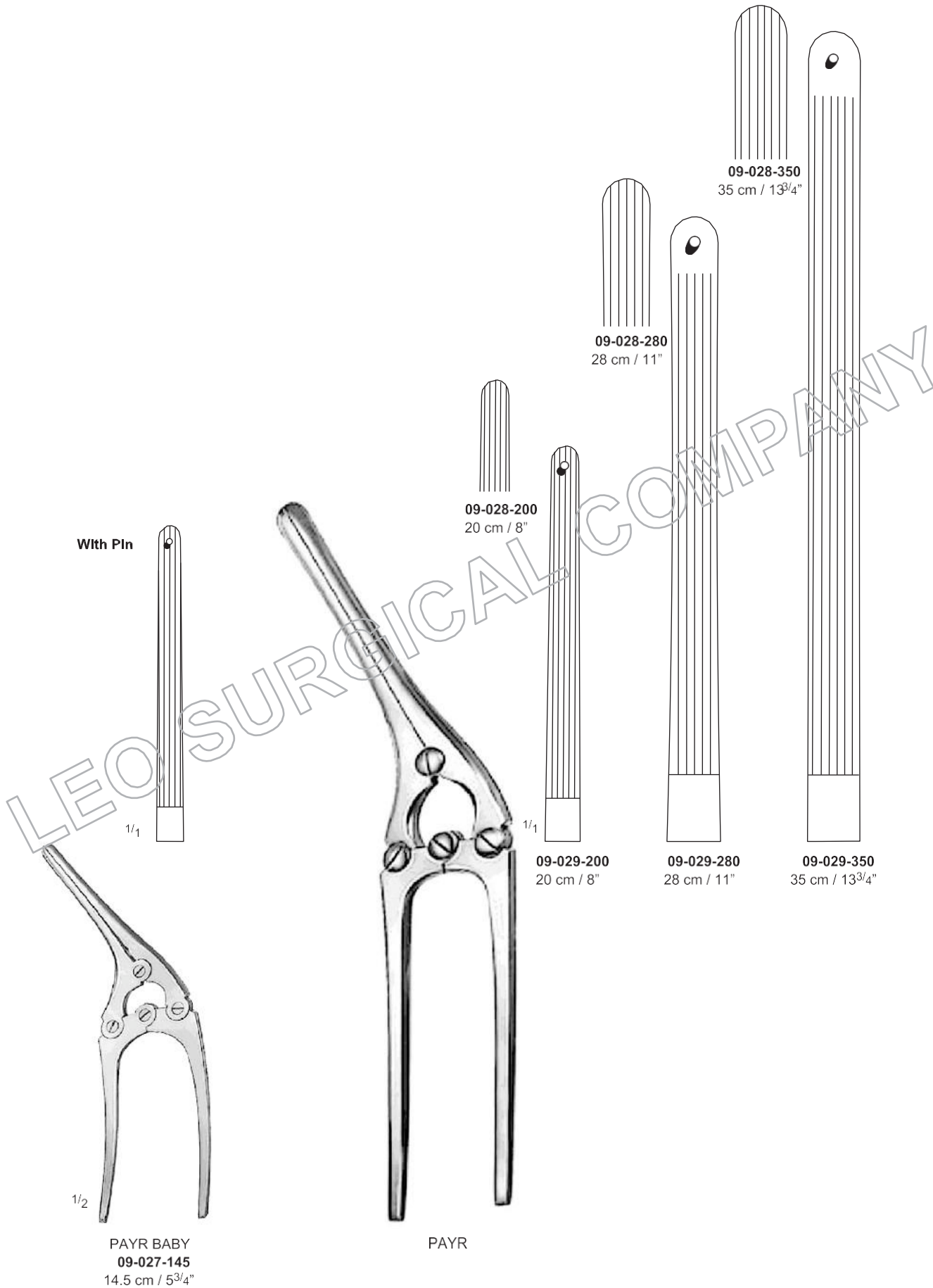

Rectal Specula

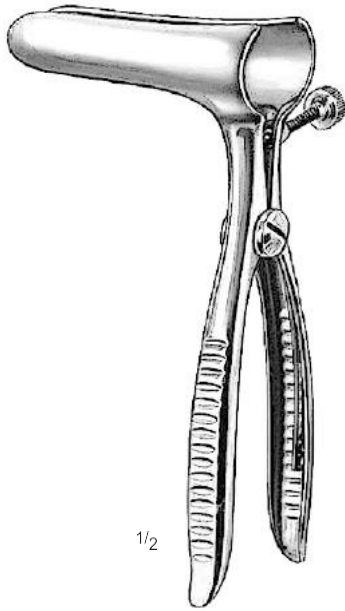

SIMS  
09-030-160  
16 cm / 6<sup>1</sup>/<sub>4</sub>"

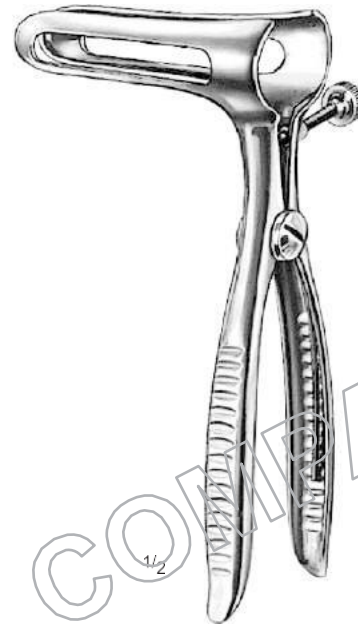

SIMS  
09-031-160  
16 cm / 6<sup>1</sup>/<sub>4</sub>"

3 Blades



MATHIEU  
09-032-210  
21 cm / 8<sup>1</sup>/<sub>4</sub>"

LEO SURGICAL COMPANY

Proctoscopes, Anoscopes, Sphincteroscopes

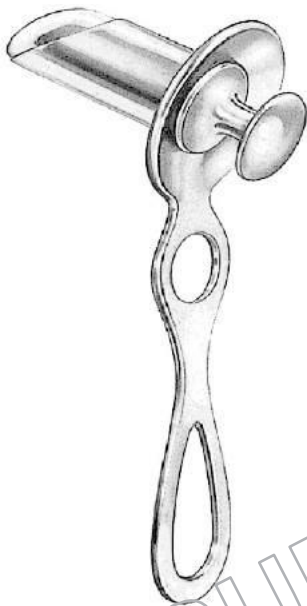

HIRSCHMANN

- 09-033-016 – ø 16 mm x 60 mm
- 09-033-019 – ø 19 mm x 70 mm
- 09-033-022 – ø 22 mm x 90 mm

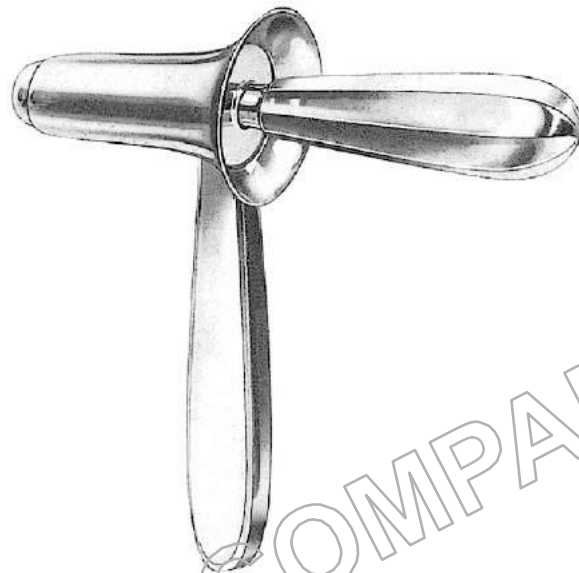

KELLY

- 09-034-021 – ø 24 mm x 50 mm
- 09-034-025 – ø 25 mm x 50 mm
- 09-034-023 – ø 23 mm x 145 mm
- 09-035-023 – ø 23 mm x 205 mm









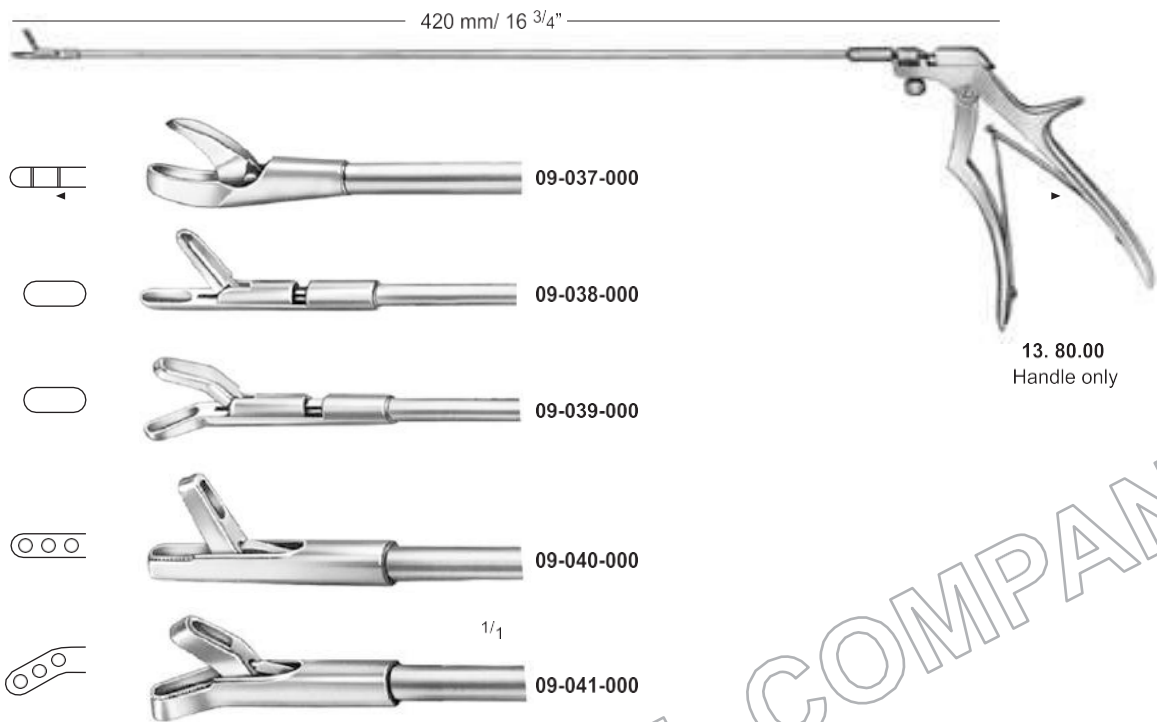



NEWMAN

- 09-036-016 – ø 16 mm x 63 mm
- 09-036-019 – ø 19 mm x 63 mm
- 09-036-023 – ø 23 mm x 63 mm

**Biopsy Specimen Forceps**



-   09-037-000
-   09-038-000
-   09-039-000
-   09-040-000
-   09-041-000

13. 80.00  
 Handle only

LEO SURGICAL COMPANY

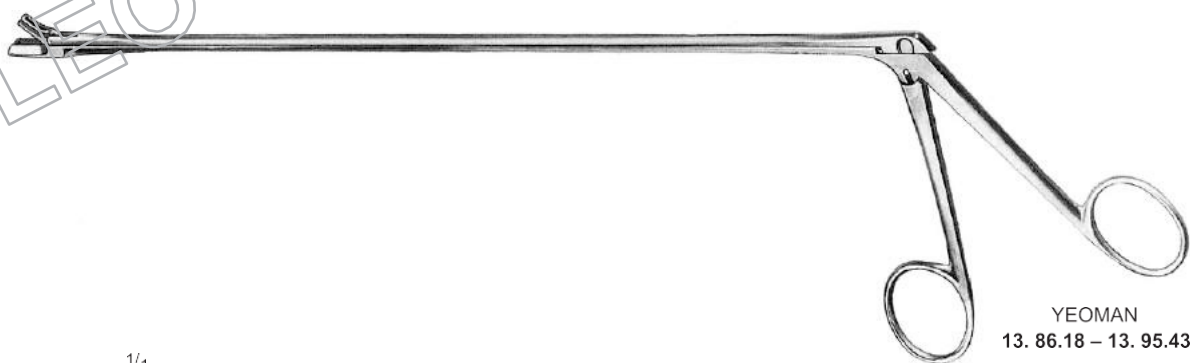

YEOMAN  
 13. 86.18 – 13. 95.43

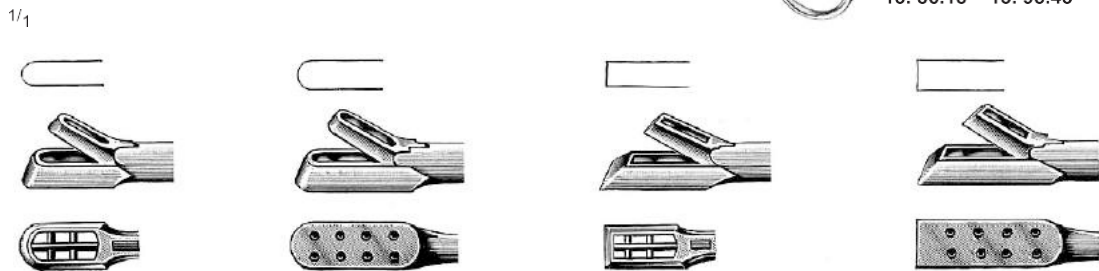

Shaft length	09-042-280	09-043-280	09-044-280	09-045-280
28 cm / 11"	09-042-280	09-043-280	09-044-280	09-045-280
35 cm / 13 <sup>3</sup> / <sub>4</sub> "	09-042-350	09-043-350	09-044-350	09-045-350
43 cm / 17"	09-042-430	09-043-430	09-044-430	09-045-430

Pelvis Retractor

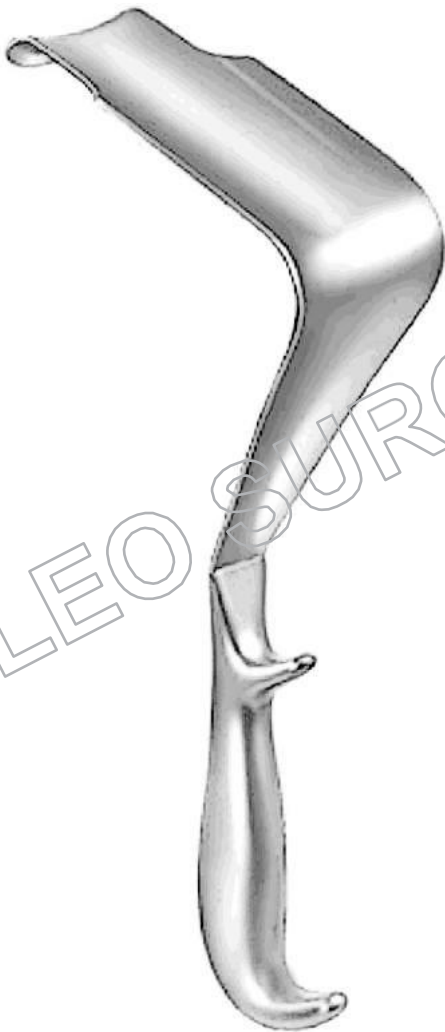

ST. MARKS  
(LLOYD DAVIS)

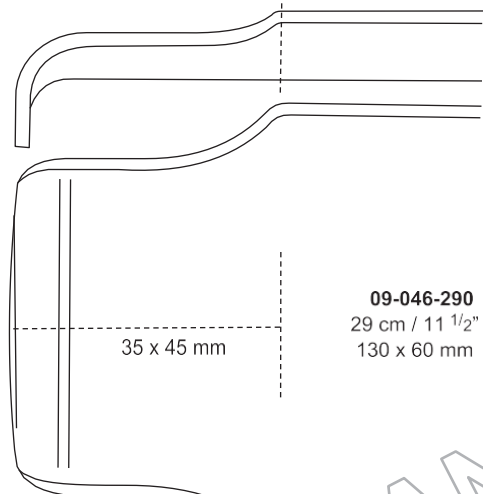

35 x 45 mm

**09-046-290**  
29 cm / 11 1/2"  
130 x 60 mm

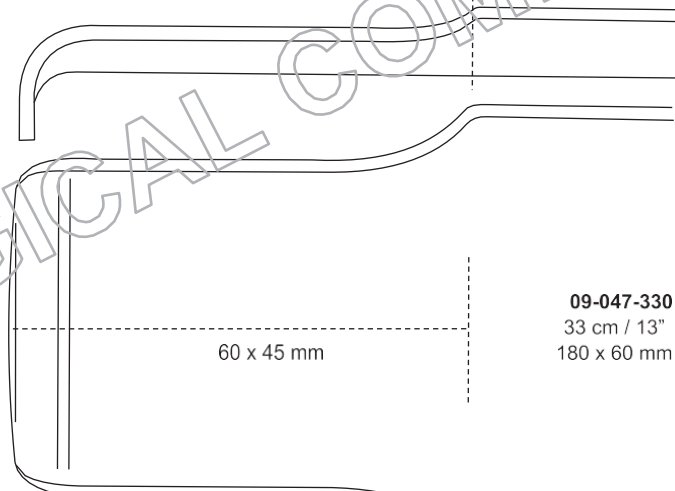

60 x 45 mm

**09-047-330**  
33 cm / 13"  
180 x 60 mm

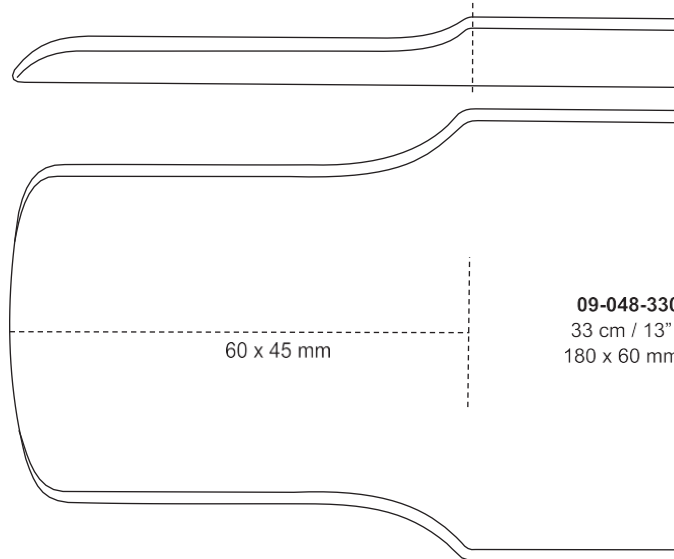

60 x 45 mm

**09-048-330**  
33 cm / 13"  
180 x 60 mm