

ORTHOPEDIC

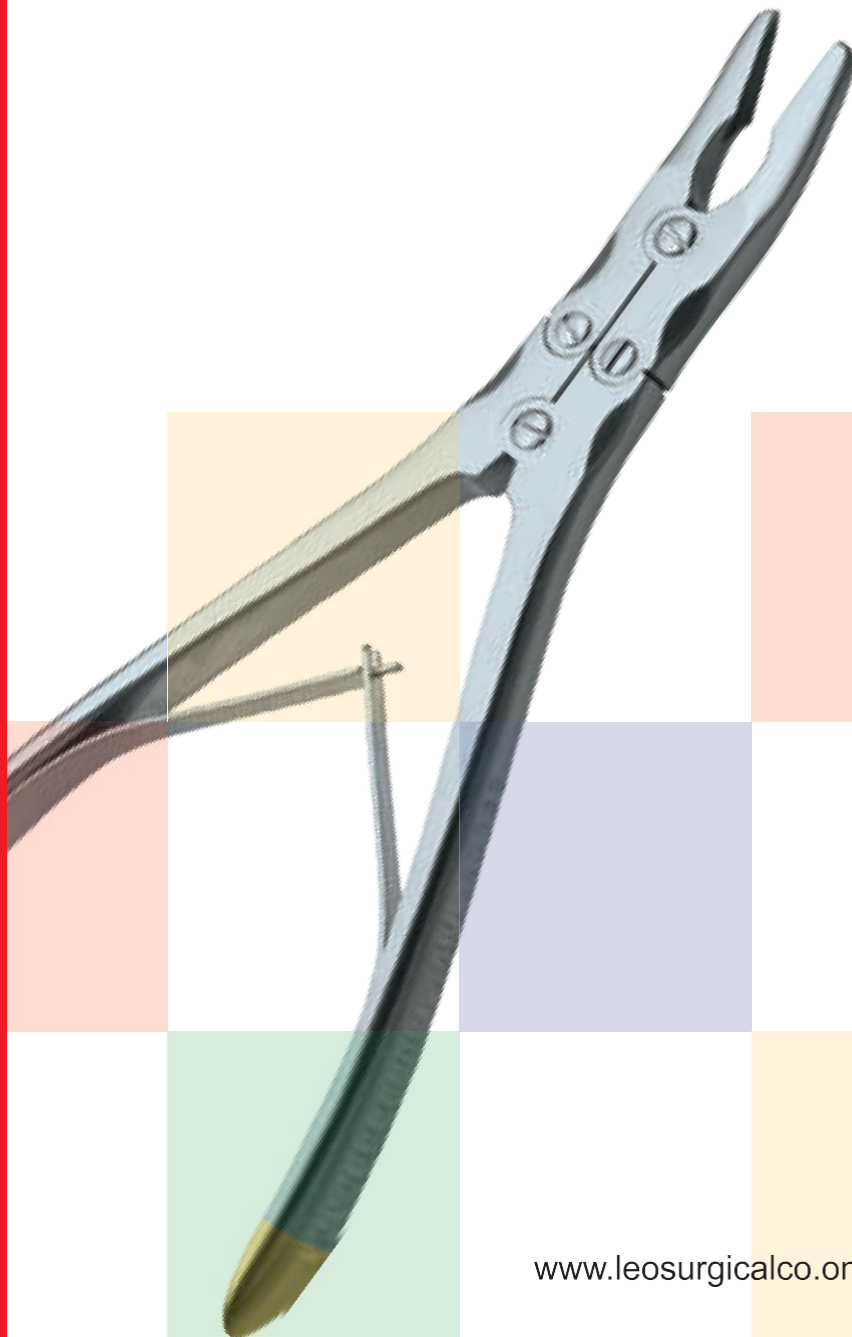

www.leosurgicalco.onlineindia.org

11

Mallets

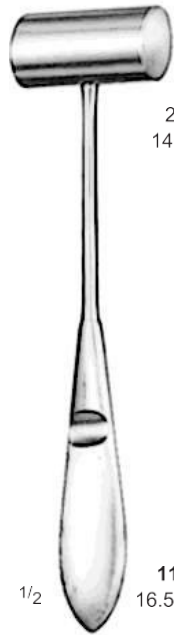

20 mm ø
140 g (5 oz)

1/2
11-001-165
16.5 cm / 6 1/2"



40 mm ø
690 g
(1 1/2" lbs)

1/2
KIRK
11-002-195
19.5 cm / 7 3/4"



30 mm & 42 mm ø
530 g 1lb. 3 oz)

1/2
11-003-240
24 cm / 9 1/2"



11-004-025
25m ø
120 g (4 1/4 oz)

11-004-030
30m ø
180 g (6 1/4 oz)

11-004-035
35m ø
260 g (9 1/4 oz)

1/2
DOYEN
21 cm / 8 1/4"

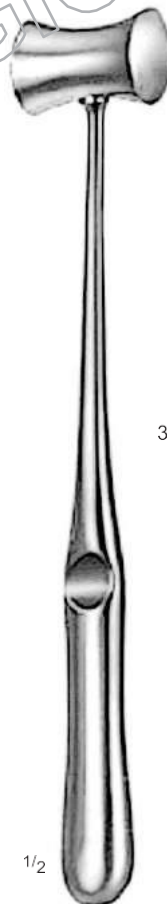

11-005-260
26m ø
300 g (10 1/4 oz)

11-005-280
28m ø
340 g (12 oz)

11-005-300
30m ø
400 g (14 oz)

1/2
WILLIGER
24 cm / 9 1/2"



30 mm ø
220 gm
(7 1/2 oz)

1/2
COLLIN
11-006-200
20 cm / 8"

Mallets



Bone Rasps & Files



1/2
1/4

PUTTI
11-014-280
 28 cm / 11"

1/2
1/2

PUTTI
11-015-300
 30 cm / 12"

20 mm

1/2

11-016-220
 22 cm / 8 3/4"

1/2

11-017-240
 24 cm / 9 1/2"

Periosteal Elevators, Raspatories

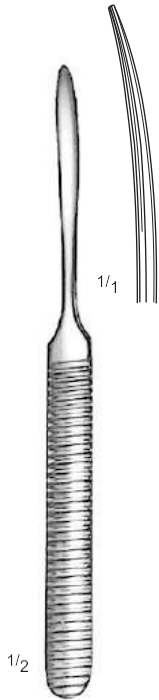

WILLIGER
11-018-170
17 cm / 6 3/4"

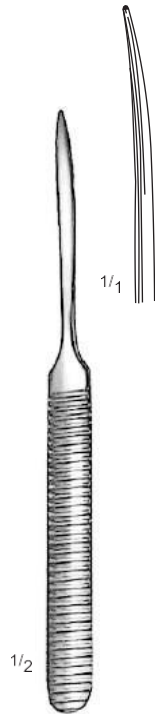

WILLIGER
11-019-160
16 cm / 6 1/4"



LANGENBECK

11-020-005
17 cm / 6 3/4"
5 mm

11-020-007
17 cm / 6 3/4"
7 mm

11-020-008
20 cm / 8"
8 mm

11-020-010
20 cm / 8"
10 mm

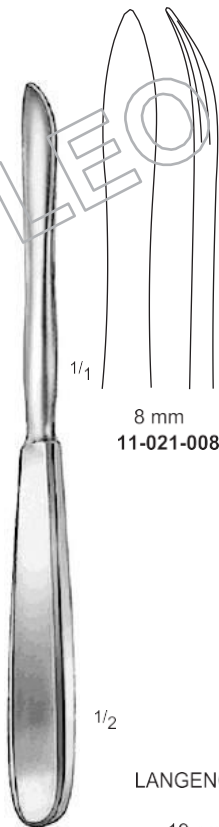

LANGENGENBECK
19 cm / 7 1/2"

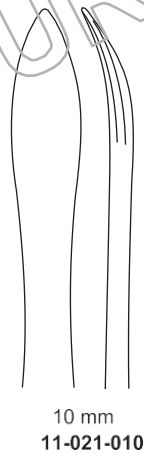

10 mm
11-021-010



HOEN



7 mm
11-022-007
16 cm / 6 1/4"



15 mm
11-022-015
19 cm / 7 1/2"

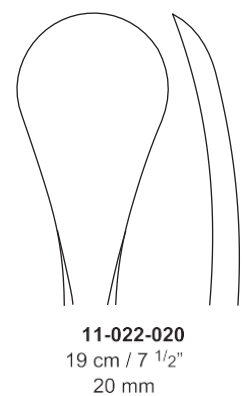

20 mm
11-022-020
19 cm / 7 1/2"

Periosteal Raspatories, Dissectors, Elevators



WILLIGER
11-023-130
13 cm / 5"

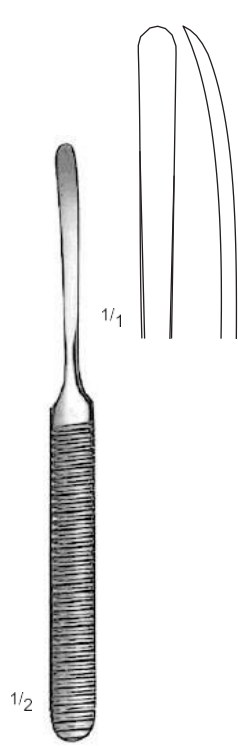

WILLIGER
11-024-160
16 cm / 6 1/4"



CUSHING

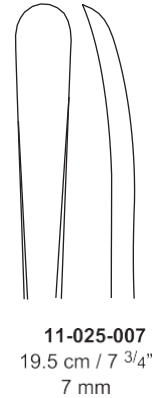
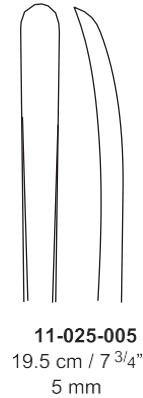
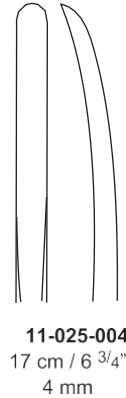

McDONALD
11-026-190
19 cm / 7 1/2"



ALDERDYCE
11-027-210
21 cm / 8 1/4"



ADSON
11-028-170
17 cm / 6 3/4"

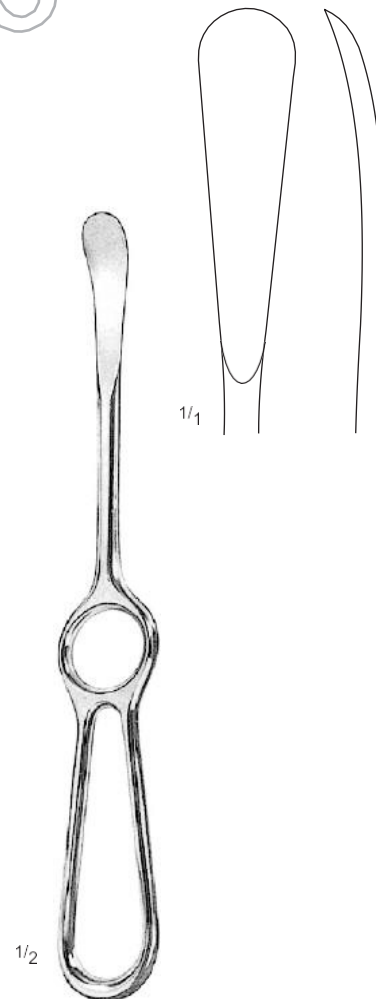
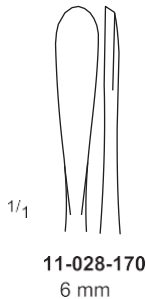
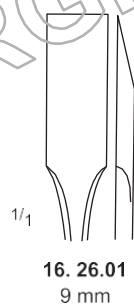

SEDILOT
11-030-210
21 cm / 8 1/4"

Periosteal Raspatories

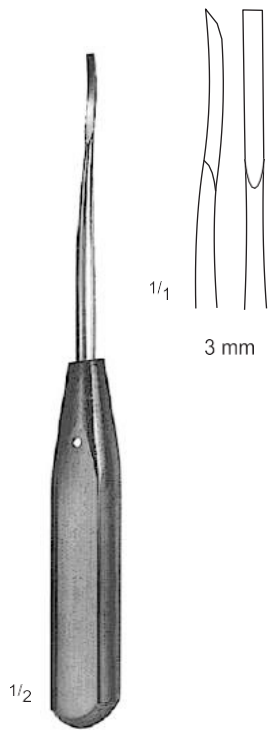

11-031-185
18.5 cm / 7 1/4"

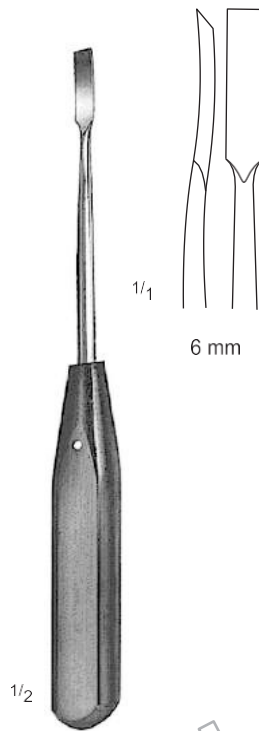

11-032-185
18.5 cm / 7 1/2"

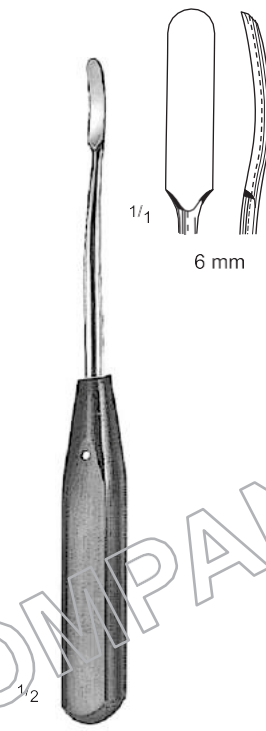

11-033-185
18.5 cm / 7 1/2"

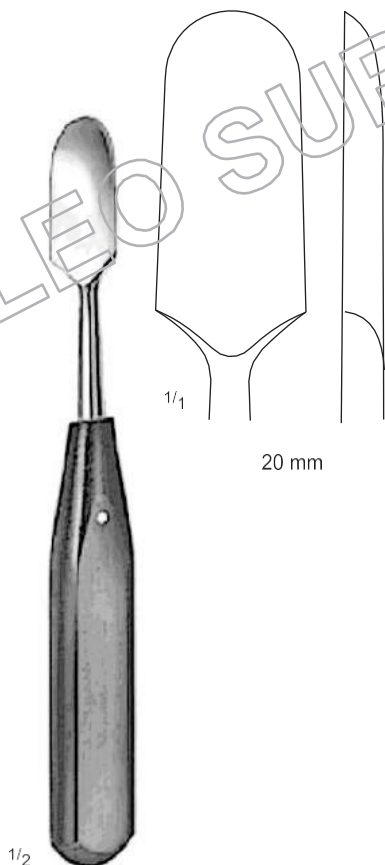

11-034-200
20 cm / 8"

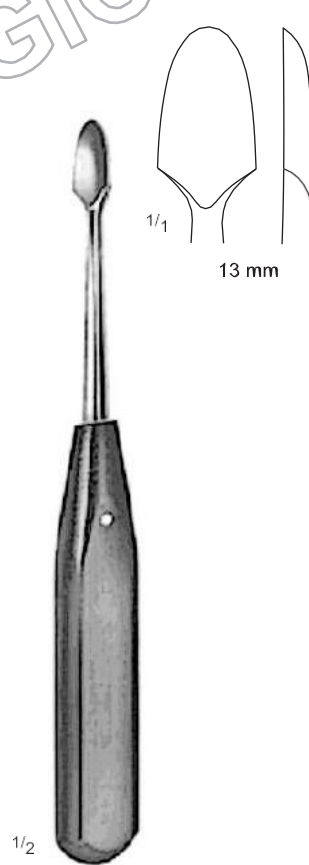

11-035-200
20 cm / 8"

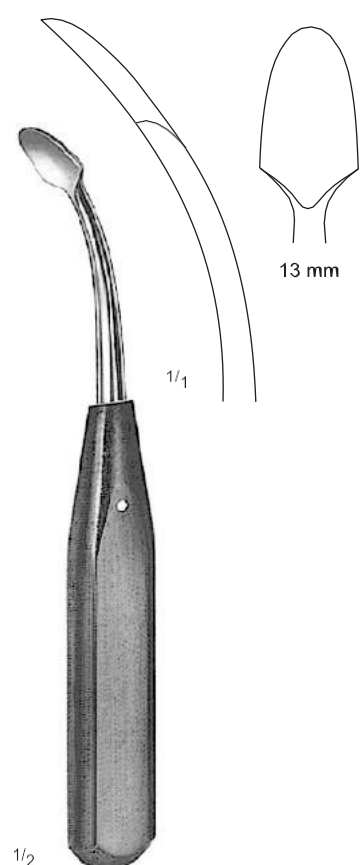

11-036-200
20 cm / 8"

Periosteal Raspatories, Bone Levers

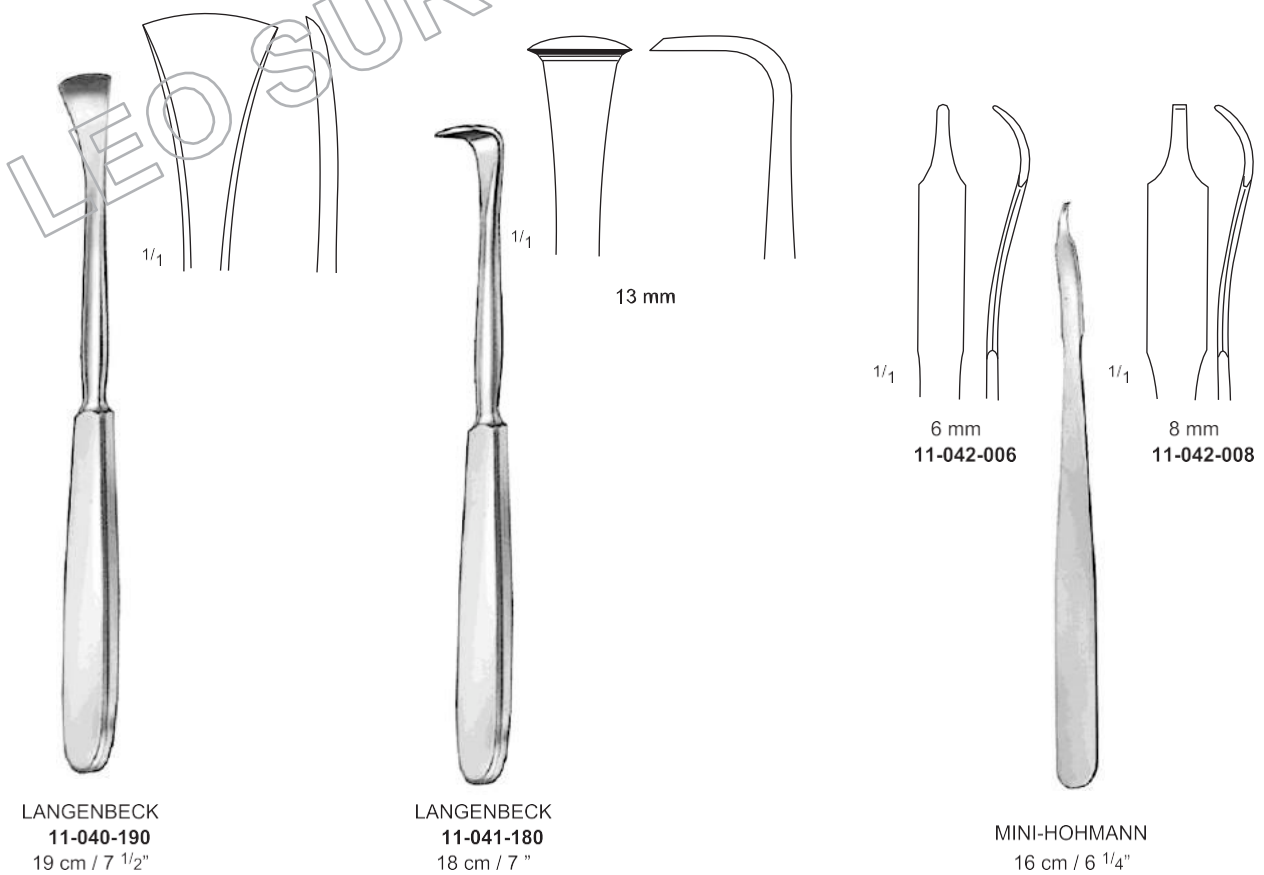
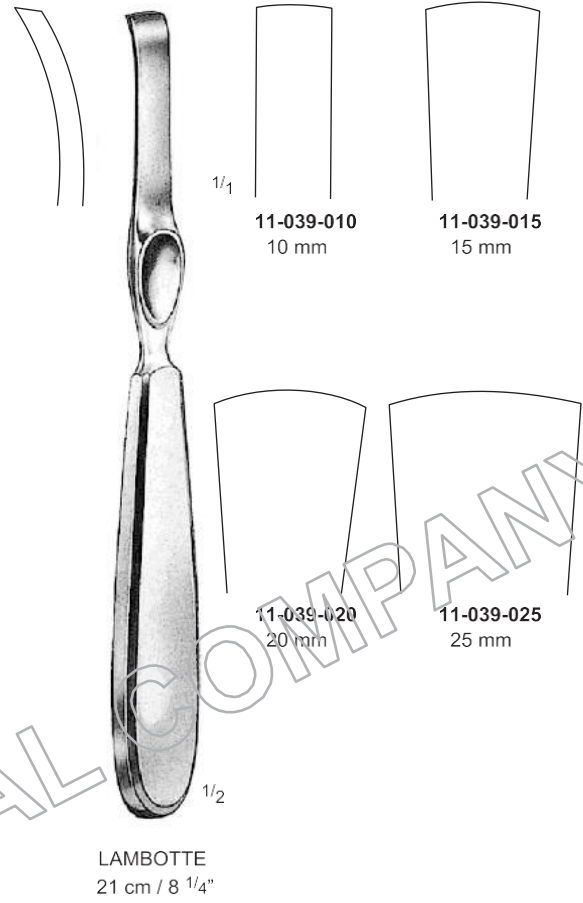
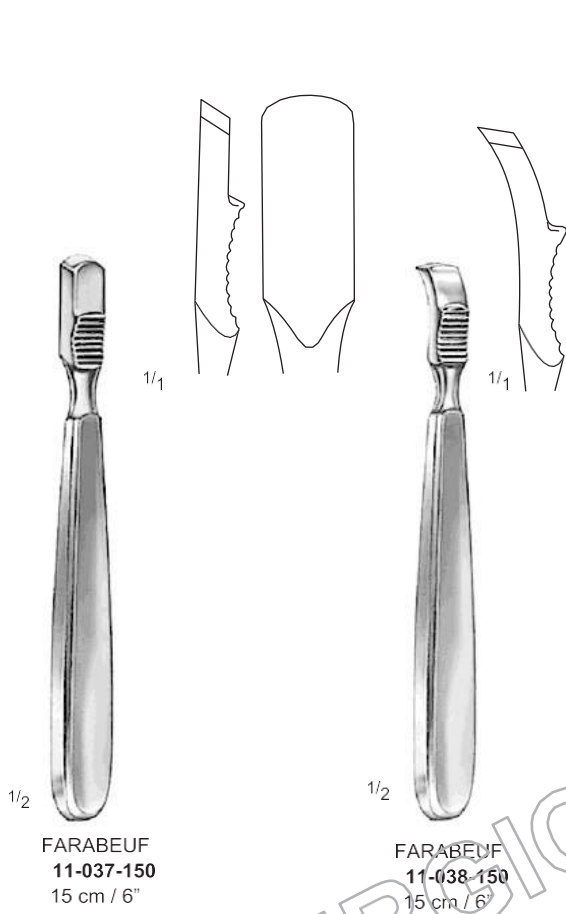

Bone Levers



HOHMANN

11-043-220
22 cm / 8 3/4"

11-044-240
24 cm / 9 1/2"

11-045-240
24 cm / 9 1/2"

11-046-290
29 cm / 11 1/2"

Bone Levers



HOHMANN

LANGE-HOHMANN

11-047-250
25 cm / 10"

11-048-280
28 cm / 11"

11-049-290
29 cm / 11 1/2"

11-050-240
24 cm / 9 1/2"

11-051-260
26 cm / 10 1/4"

Bone Cutting Forceps



11-052-230
23 cm / 9"



CLEVELAND
11-053-150
15 cm / 6"

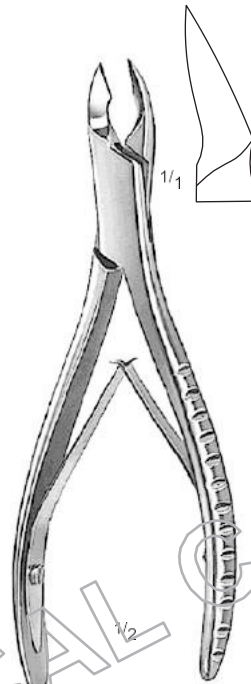

CLEVELAND
11-054-170
17 cm / 6 3/4"

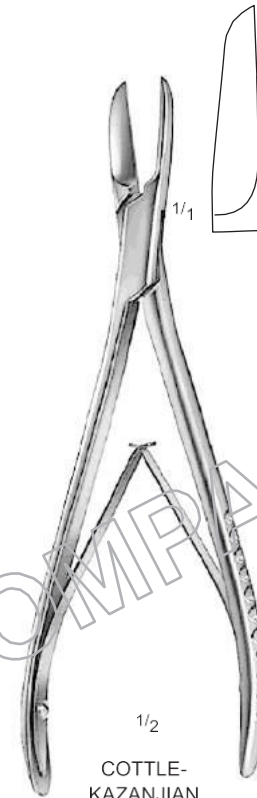

COTTLE-
KAZANJIAN
11-055-180
18 cm / 7"



11-056-140
14 cm / 5 1/2"



11-056-170
17 cm / 6 3/4"



11-057-140
14 cm / 5 1/2"



11-057-170
17 cm / 6 3/4"

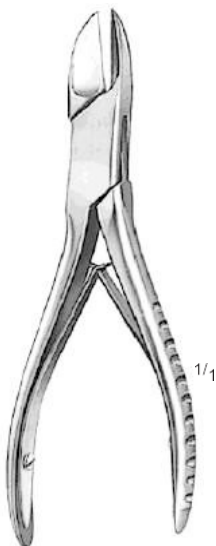

11-056-190
19 cm / 7 1/2"

LISTON



11-056-220
22 cm / 8 3/4"



11-057-190
19 cm / 7 1/2"

LISTON

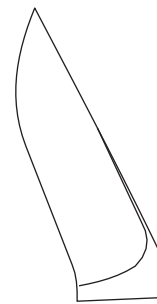
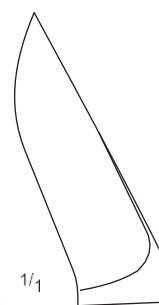

11-057-22
22 cm / 8 3/4"

Bone Holding Clamps



GERSTER-LOWMAN

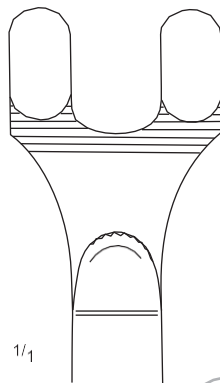
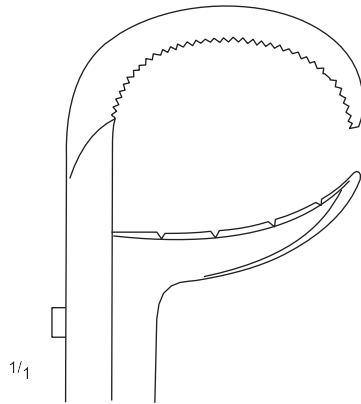

11-058-180
 18 cm / 7"

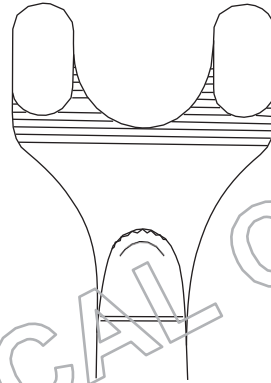

11-058-200
 20 cm / 8"

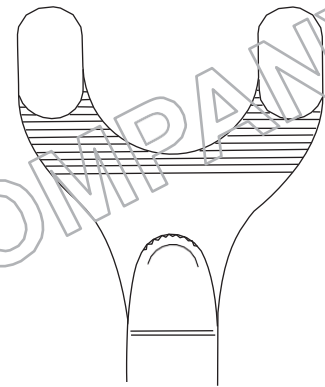

11-058-220
 22 cm / 8 3/4"

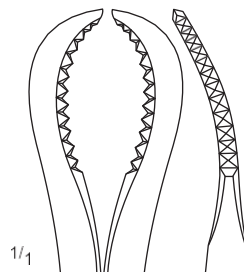
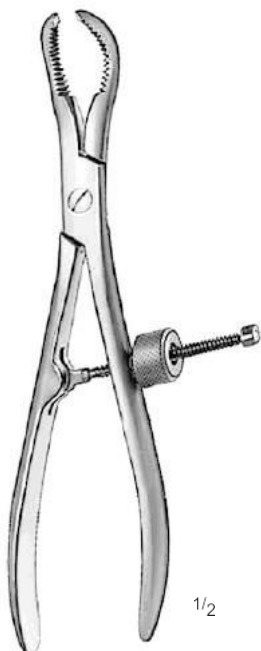

11-059-160
 16 cm / 6 1/4"

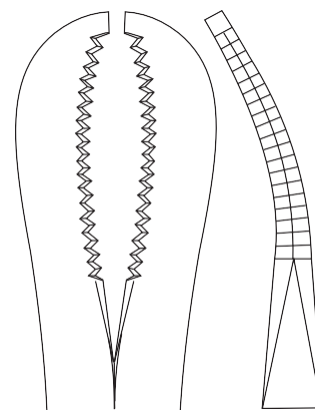

11-059-220
 22 cm / 8 3/4"

1/2

1/1

1/1

1/1

LEO SURGICAL COMPANY

Bone Cutting Forceps

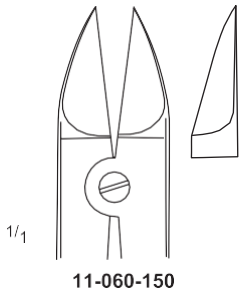

11-060-150

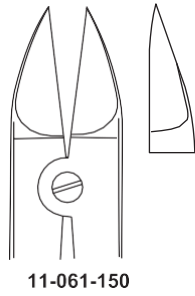
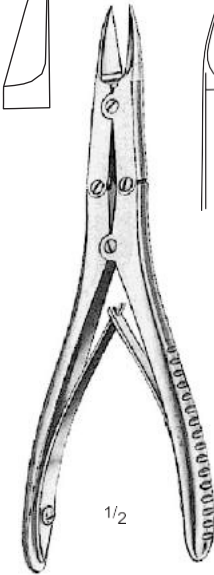

11-061-150

LISTON MINI
 15 cm / 6"

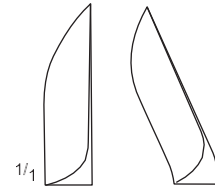
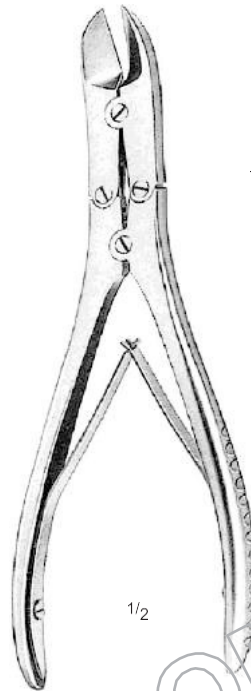

11-062-180

11-063-180

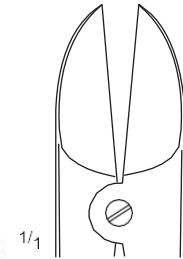

RUSKIN LISTON
 18 cm / 7"

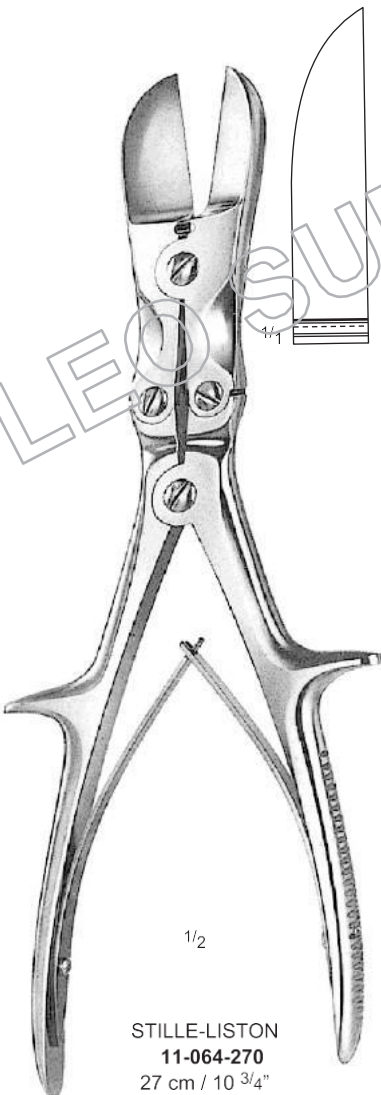

STILLE-LISTON
 11-064-270
 27 cm / 10 3/4"

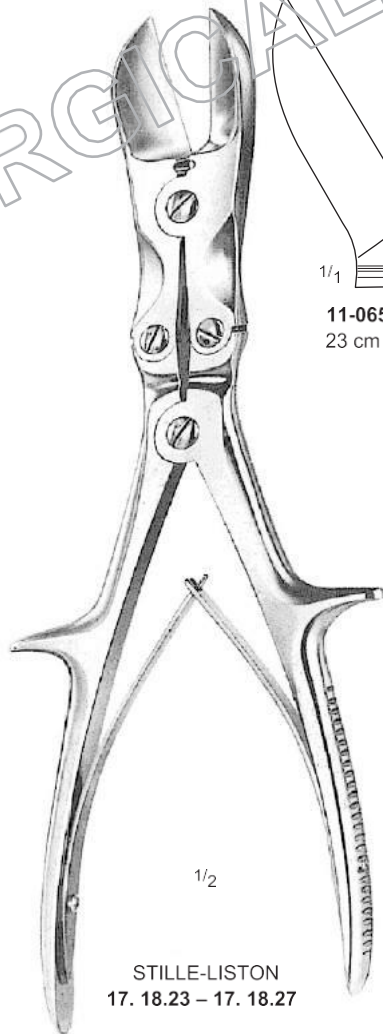

STILLE-LISTON
 17.18.23 - 17.18.27



11-065-230
 23 cm / 9"

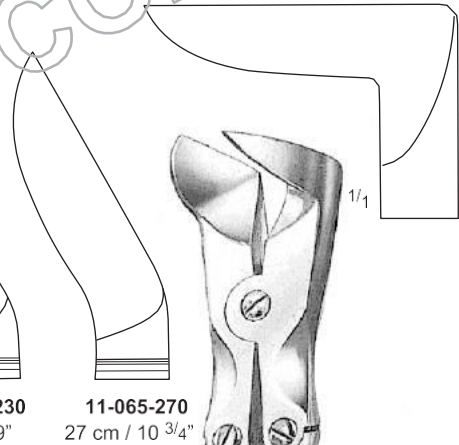

11-065-270
 27 cm / 10 3/4"

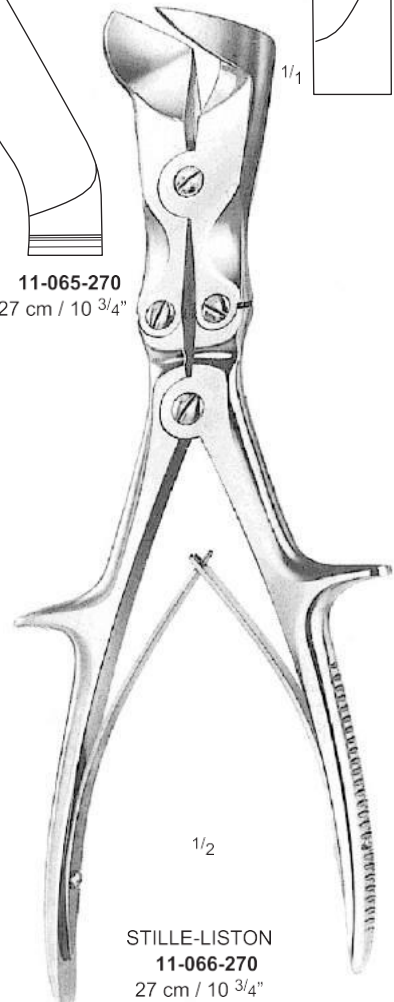

STILLE-LISTON
 11-066-270
 27 cm / 10 3/4"

Bone Holding Forceps

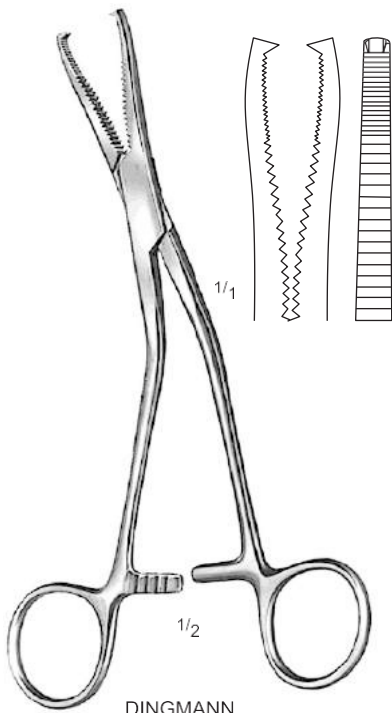

DINGMANN
 11-067-190
 19 cm / 7 1/2"



11-068-140
 14 cm / 5 1/2"

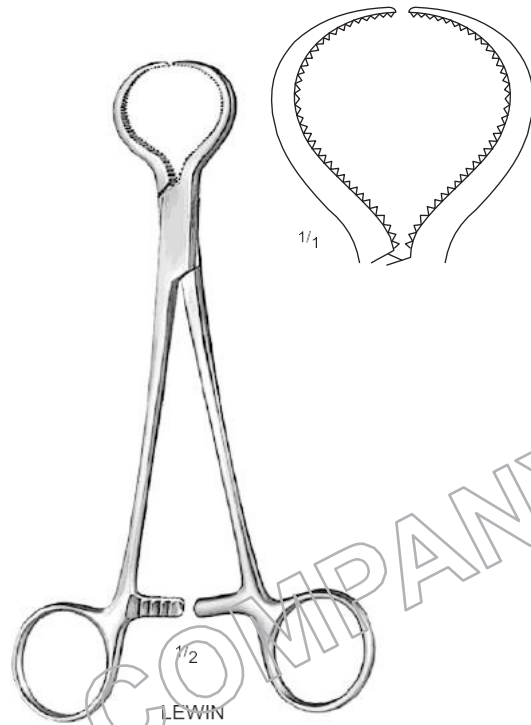

LEWIN
 11-069-180
 18 cm / 7"

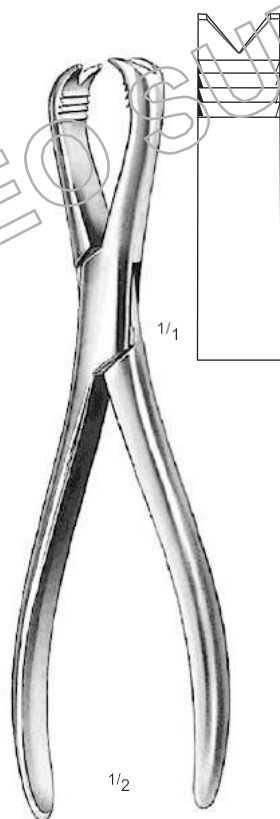

LANGENBECK
 11-070-210
 21 cm / 8 1/4"

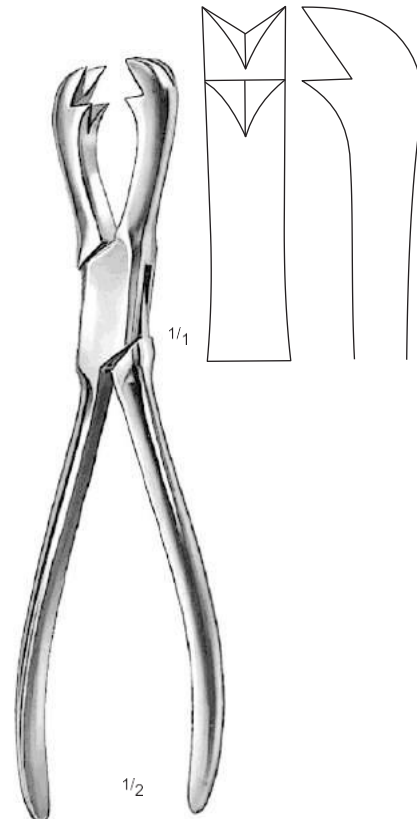

FERGUSON
 11-071-210
 21 cm / 8 1/4"

Bone Holding Forceps

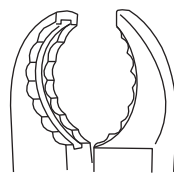
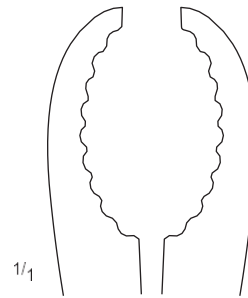
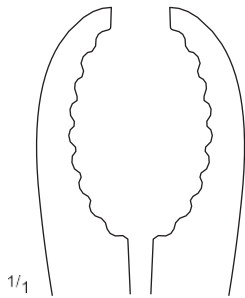

11-072-230
 11-073-230
 23 cm / 9"

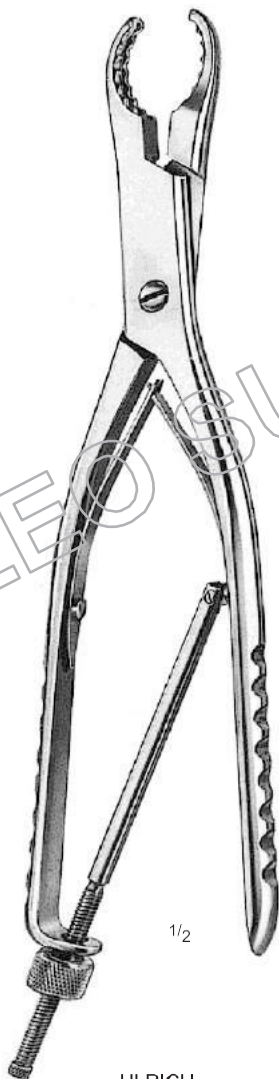

ULRICH
 11-072-230 - 11-072-280



11-072-250
 11-073-250
 25 cm / 10"

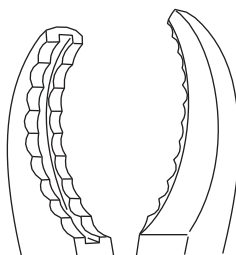

11-072-280
 11-073-280
 28 cm / 11"

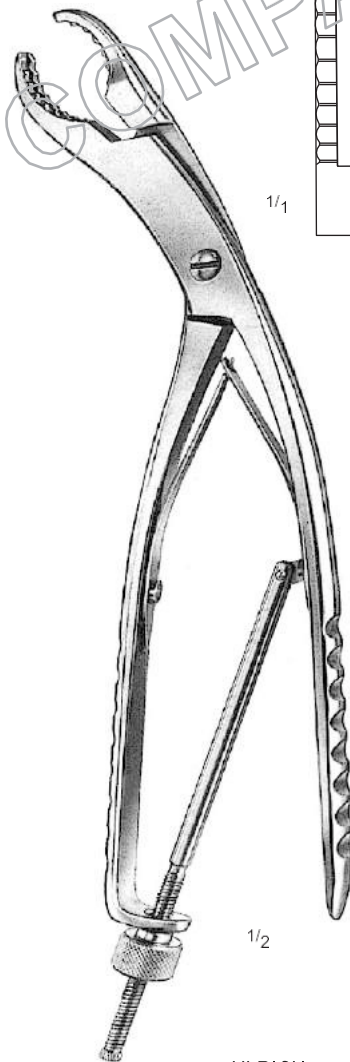

ULRICH
 11-073-230 - 11-073-280

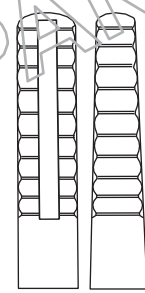

Bone Holding Forceps

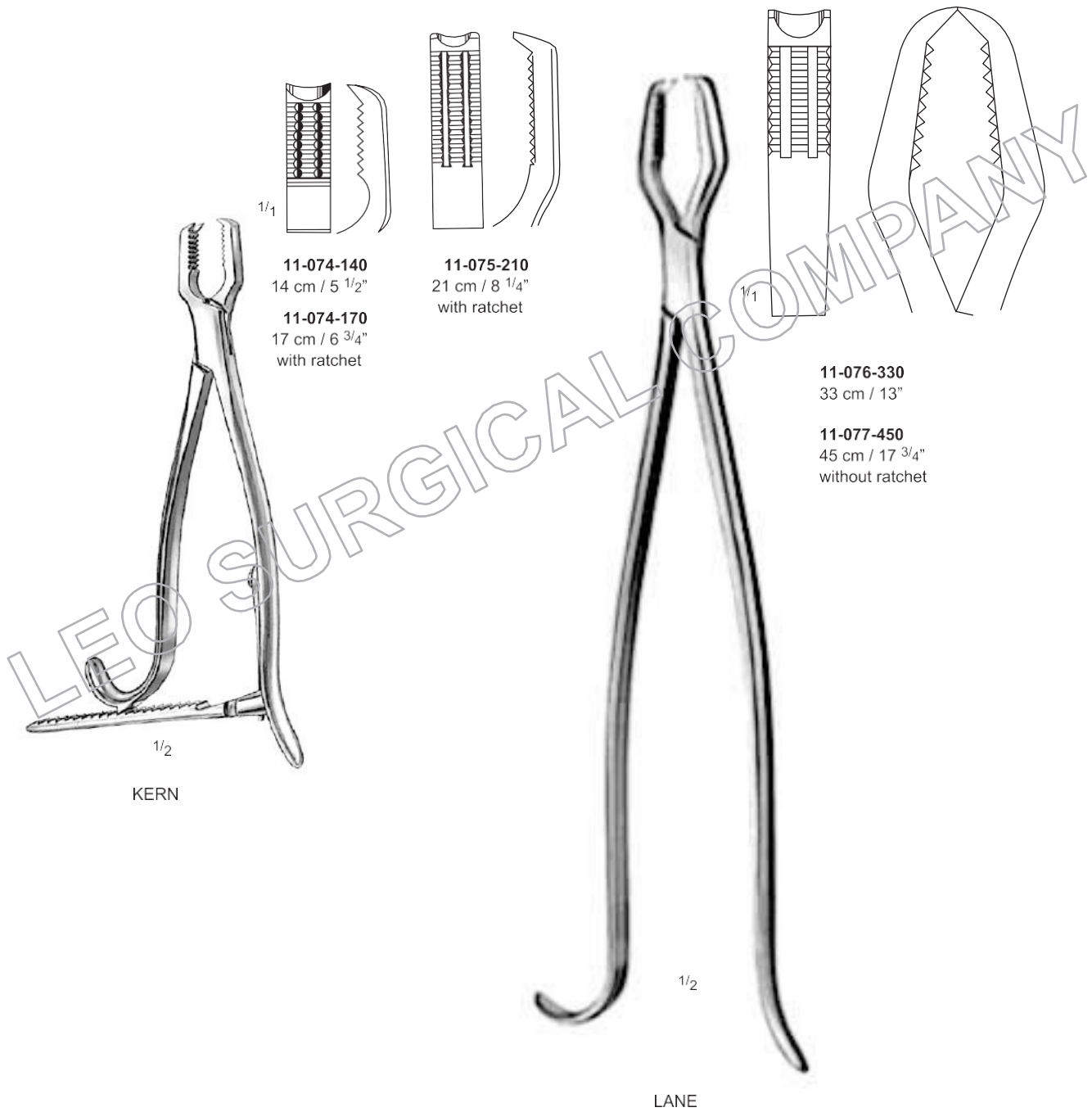

Bone Holding Forceps

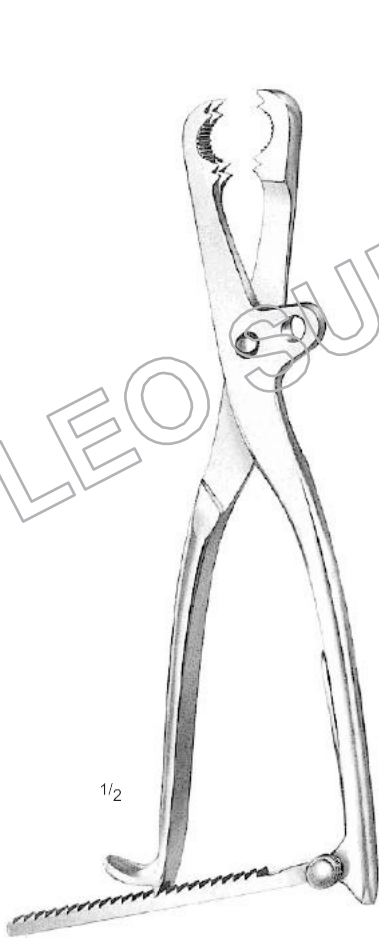
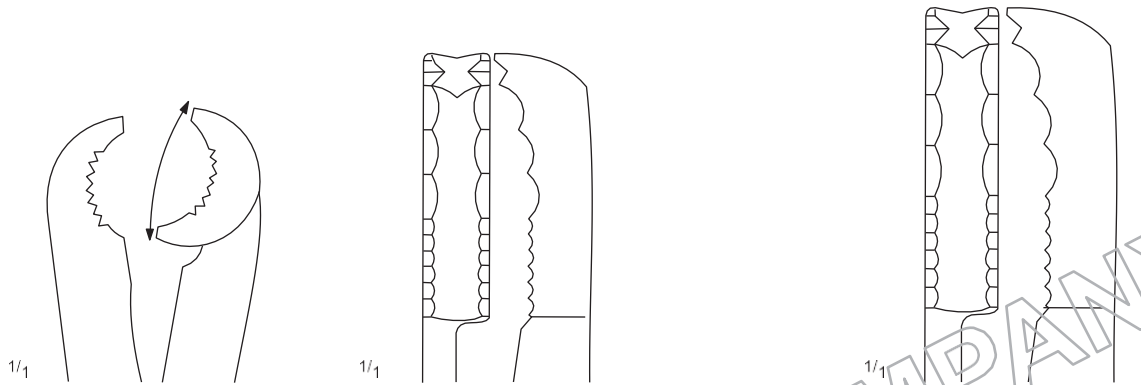

LAMBOTTE
 11-078-210 – 21 cm / 8 1/4"
 11-078-250 – 25 cm / 10"
 11-078-300 – 30 cm / 12"



FARABEU
 11-079-230 – 23 cm / 9"
 11-079-250 – 25 cm / 10"

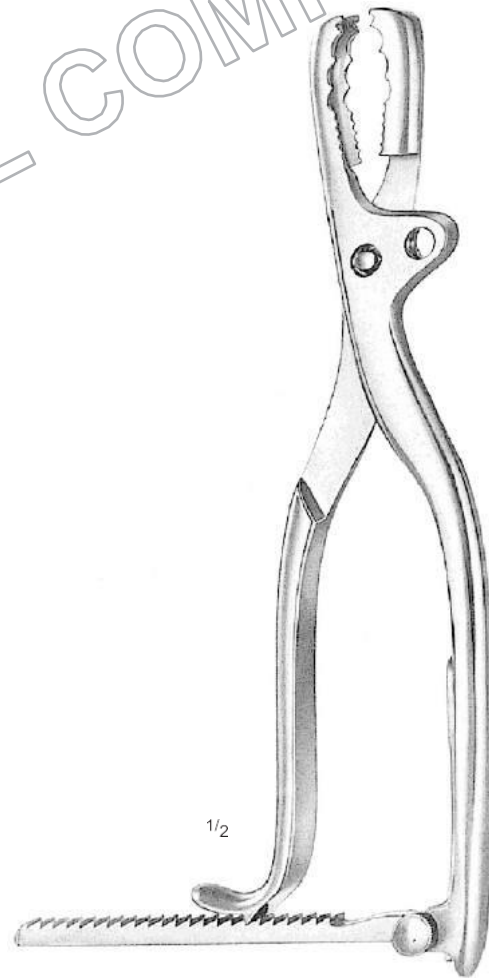

FARABEU - LAMBOTTE
 11-080-260
 26 cm / 10 1/4"

Bone Holding Forceps

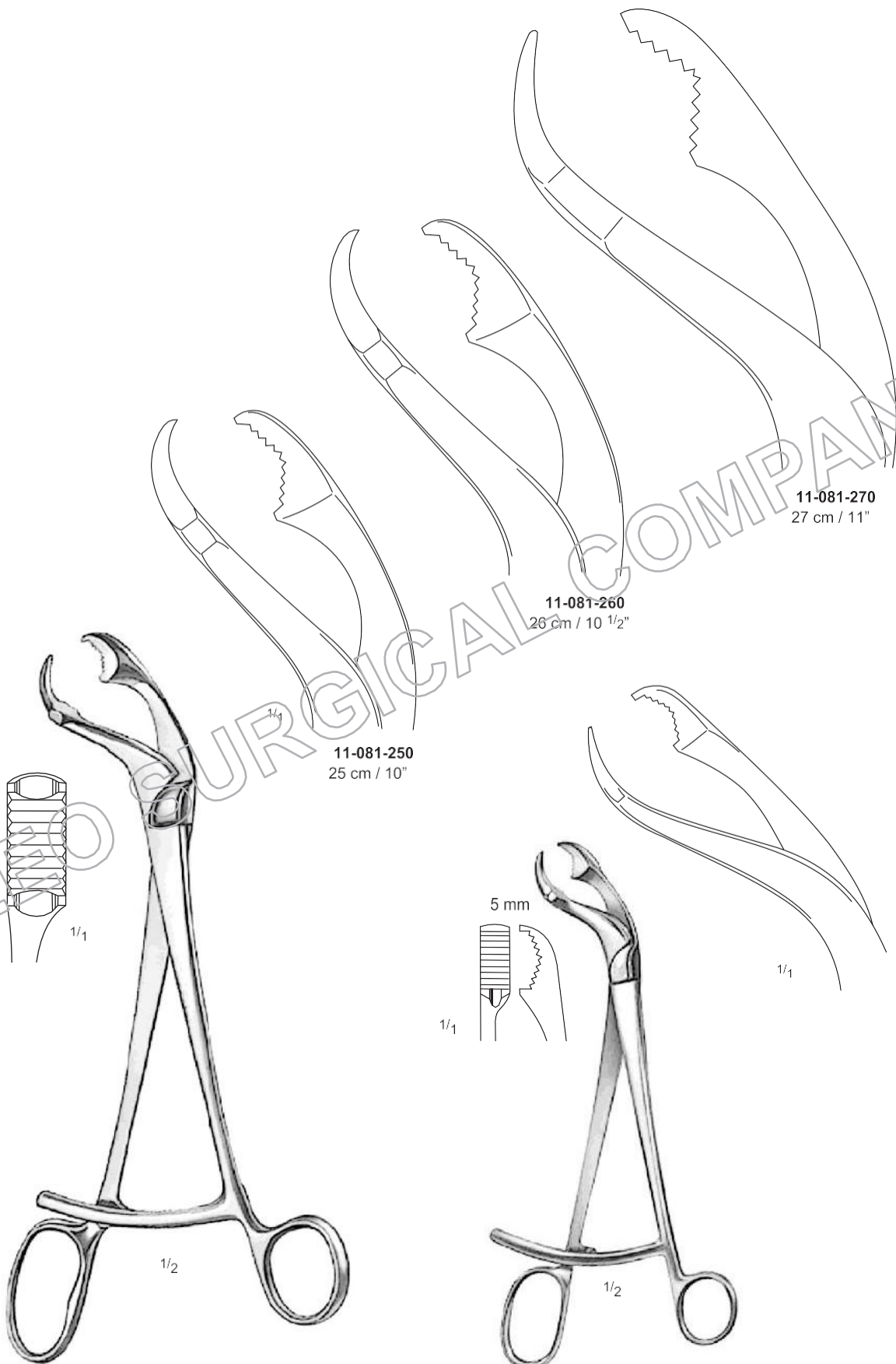

11-081-250
 25 cm / 10"

11-081-260
 26 cm / 10 1/2"

11-081-270
 27 cm / 11"

VERBRUGGE

VERBRUGGE
11-082-175
 17.5 cm / 6 3/4"

Amputating Saws, Wire Saws, Wire Saw Handles



LANGENBECK
11-083-230
 23 cm / 9"



CHARRIERE
11-084-270 – 27 cm / 10 3/4"
 Blade Length 15 cm / 6"

11-084-300 – 30 cm / 12"
 Blade Length 20 cm / 8"

11-084-340 – 34 cm / 13 1/2"
 Blade Length 25 cm / 10"



SATERLEE
11-085-290
 29 cm / 11 1/2"
 Blade Length 21 cm / 8 1/4"



CHARRIERE
11-086-350
 35 cm / 14"



GIGLI
11-087-300 – 30 cm / 12"
11-087-400 – 40 cm / 15 3/4"
11-087-500 – 50 cm / 19 3/4"
11-087-600 – 60 cm / 23 3/4"
11-087-700 – 70 cm / 27 1/2"



GIGLI
11-088-000
 (Pair of Handles)

Flat Nose Pliers, Wire Cutting Pliers, with Tungsten Carbide, T/C Inserts



18 cm / 7"

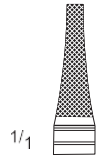

11-089-180



11-090-180



18-091-180

with Tungsten Carbide, T/C

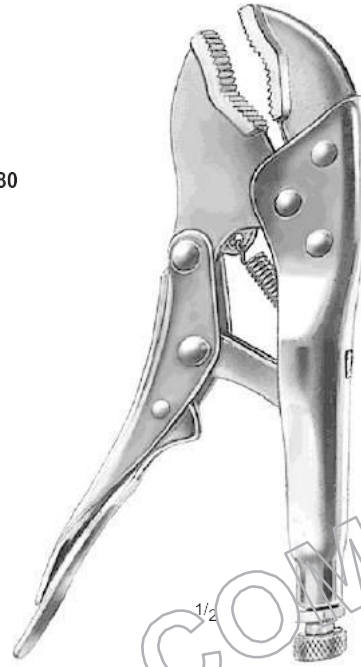

11-092-180
18 cm / 7"



1/4



11-093-160
16 cm / 6 1/4"



For hard wires
upto \varnothing 1.5 mm

For soft wires
upto \varnothing 2.0 mm



11-094-180
18 cm / 7"

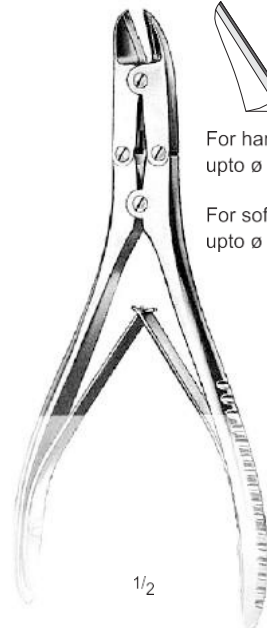

11-095-170
17 cm / 6 3/4"

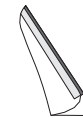

For hard wires
upto \varnothing 1.6 mm

For soft wires
upto \varnothing 2.0 mm

LEO SURGICAL COMPANY

Wire Cutting Pliers, with Tungsten Carbide, T/C Inserts

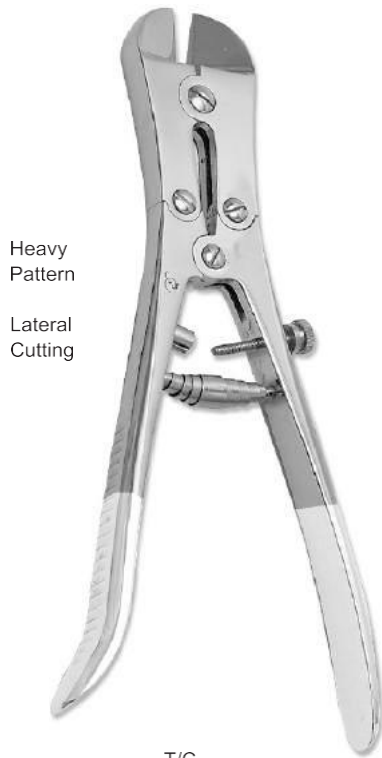

Heavy Pattern
 Lateral Cutting

T/C
11-096-240
 24 cm / 9 1/2"



For Hard Wires
 upto ø 2.5 mm

T/C
11-097-220
 22 cm / 8 3/4"



MEGA CUT
11-100-470
 47 cm / 17 3/4"
 For cutting off
 Kirschner wires,
 Tibia head screws,
 bolts, pins upto
 6.0 mm ø

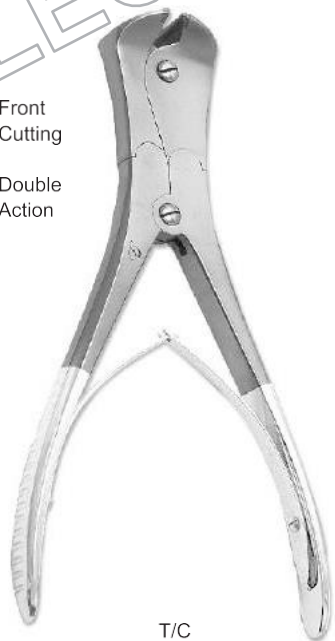

Front Cutting
 Double Action

T/C
11-098-150
 15 cm / 6"
11-098-230

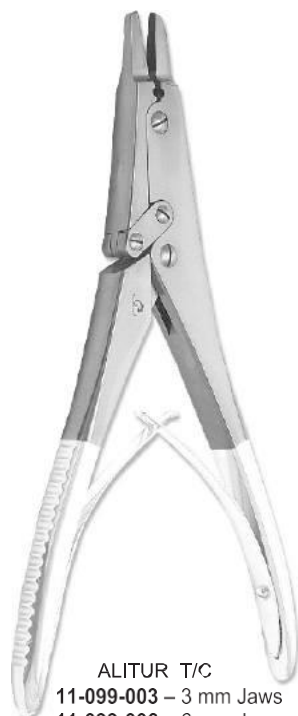

ALITUR T/C
11-099-003 – 3 mm Jaws
11-099-006 – 6 mm Jaws
 18 cm / 7"

11-100-560
 56 cm / 22 1/2"
 T/C
 For hard wires
 upto ø 2.5 mm

Bone Chisels

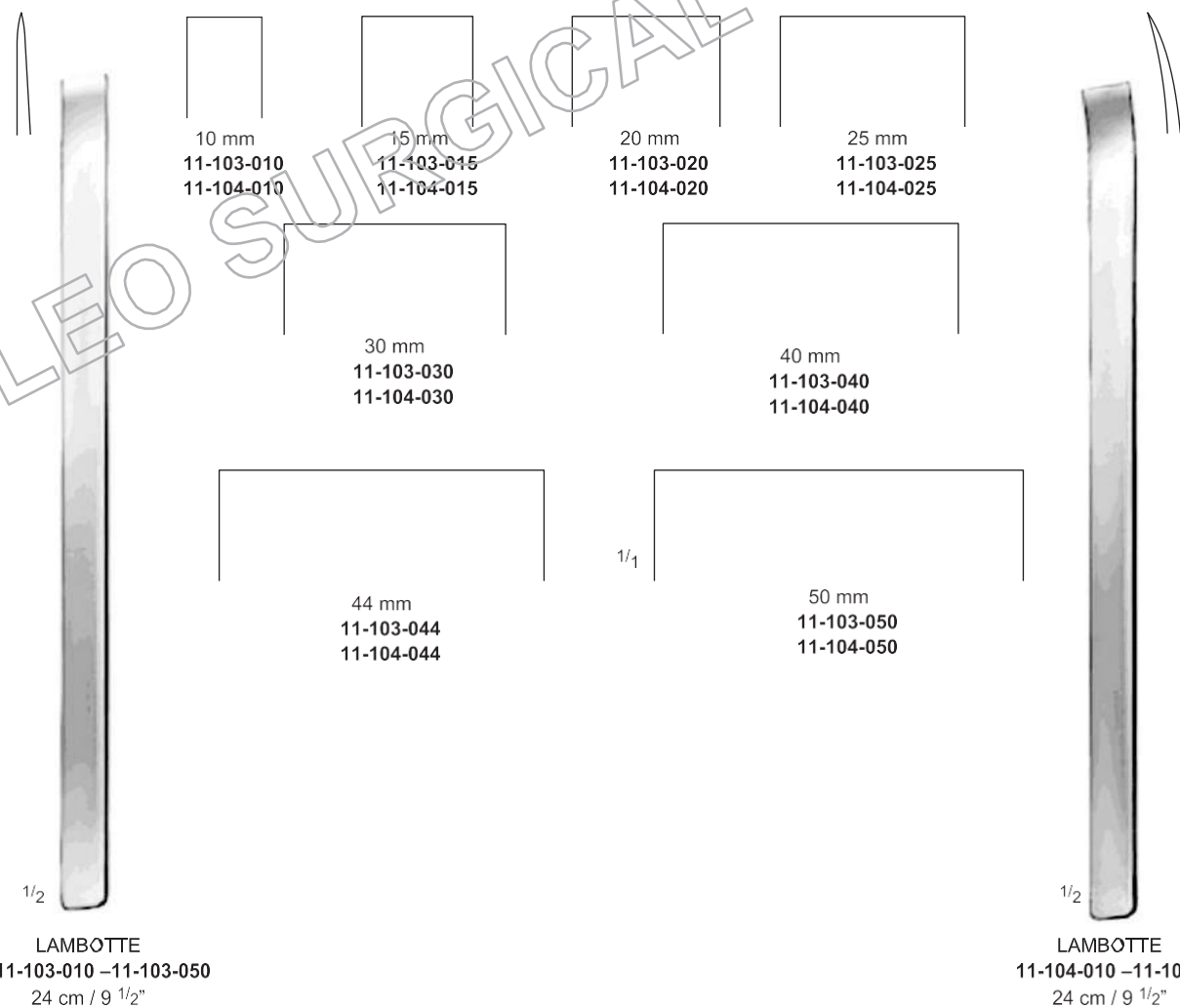
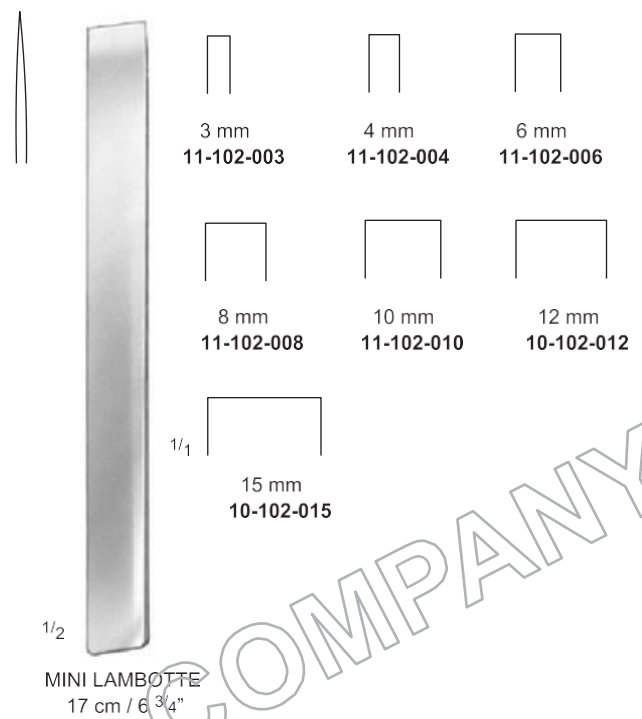
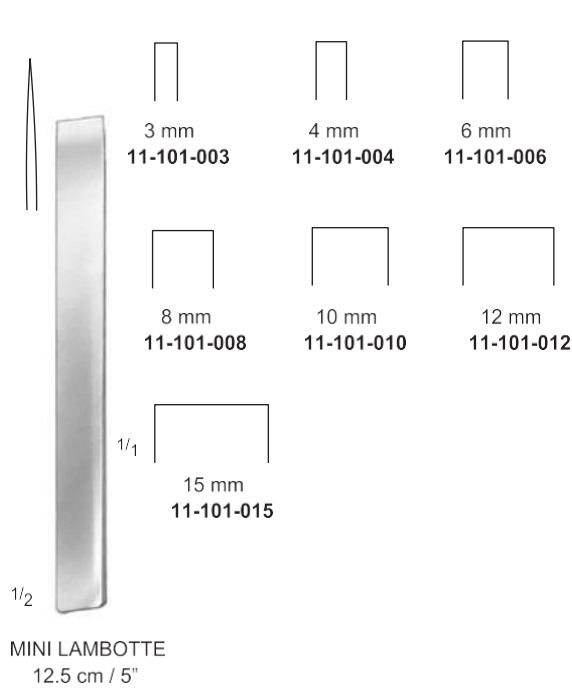

Bone Chisels and Gouges

13.5 cm / 5 1/4"



2 mm
11-105-002

17 cm / 6 3/4"



2 mm
11-106-002

13.5 cm / 5 1/4"



2 mm
11-107-002

17 cm / 6 3/4"



2 mm
11-108-002



4 mm
11-109-004



4 mm
11-110-004



6 mm
11-109-006



6 mm
11-110-006



3 mm
11-105-003



3 mm
11-106-003



3 mm
11-107-003



3 mm
11-108-003



8 mm
11-109-008



8 mm
11-110-008



4 mm
11-105-004



4 mm
11-106-004



4 mm
11-107-004



4 mm
11-108-004



10 mm
11-109-010



10 mm
11-110-010



5 mm
11-105-005



5 mm
11-106-005



5 mm
11-107-005



5 mm
11-108-005



12 mm
11-109-012



12 mm
11-110-012



6 mm
11-105-006



6 mm
11-106-006



6 mm
11-104-007



6 mm
11-108-006



14 mm
11-109-014



14 mm
11-110-014



PARTSCH



PARTSCH



ALEXANDER
18 cm / 7"



Bone Chisels and Gouges



10 mm
 11-111-010



10 mm
 11-112-010

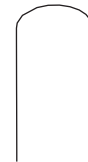

10 mm
 11-113-010

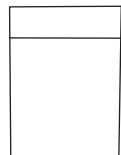

15 mm
 11-111-015



15 mm
 11-112-015



15 mm
 11-113-015



20 mm
 11-111-020



20 mm
 11-112-020

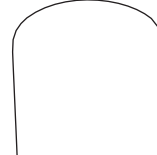

20 mm
 11-113-020

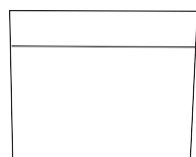

25 mm
 11-111-025



25 mm
 11-112-025

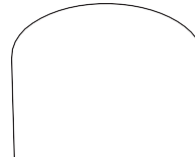

25 mm
 11-113-025



STILLE
 20 cm / 8"



STILLE
 20 cm / 8"



STILLE
 20 cm / 8"

Bone Chisels and Gouges

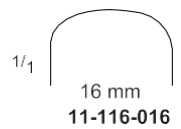
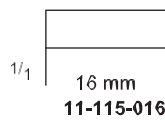
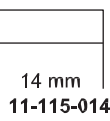
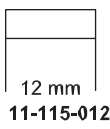
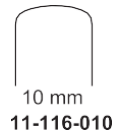
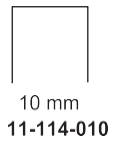
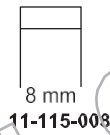

13.5 cm / 5 1/4"



13.5 cm / 5 1/4"



13.5 cm / 5 1/4"

Bone Chisels and Gouges

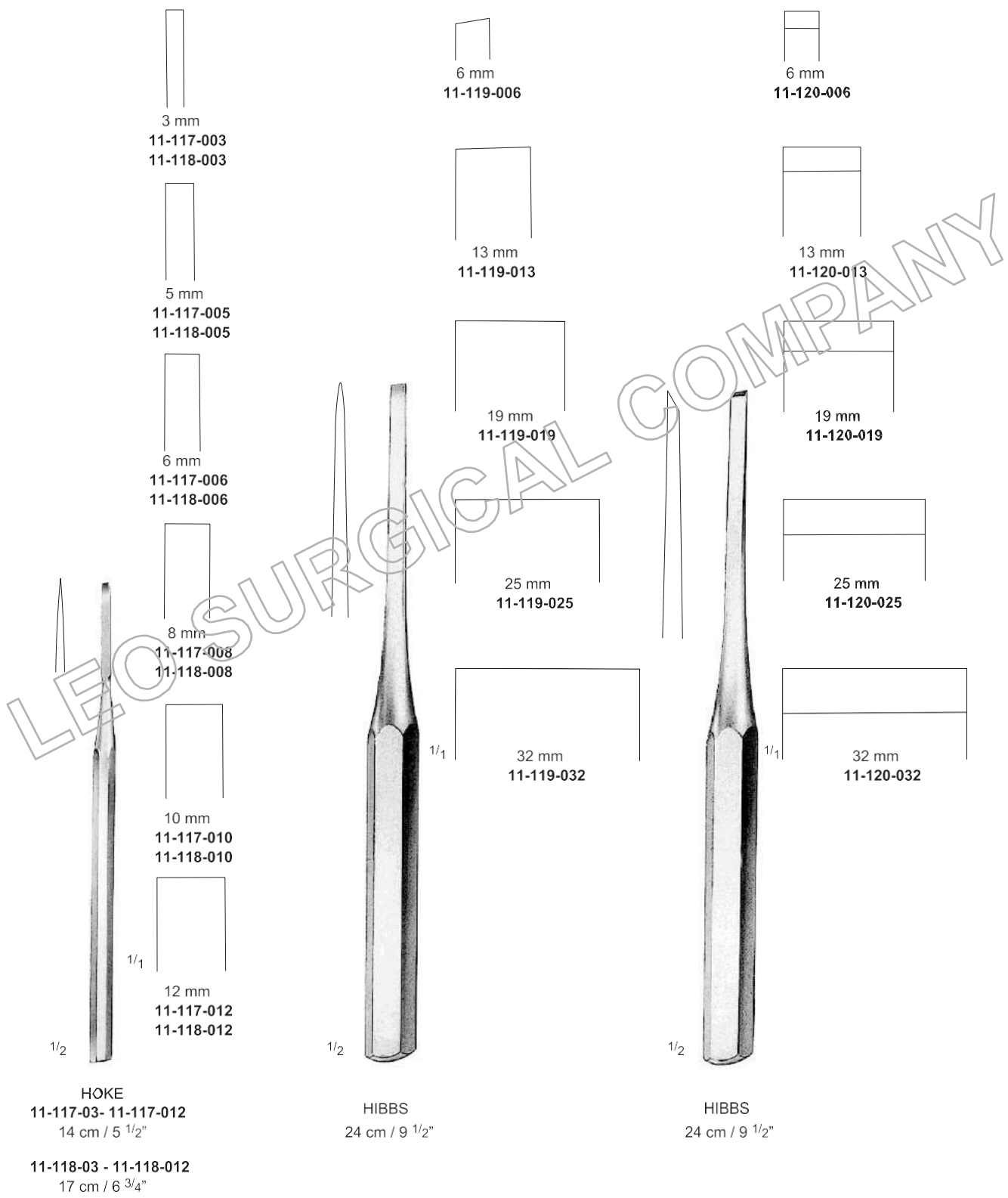

HOKE
11-117-03 - 11-117-012
14 cm / 5 1/2"
11-118-03 - 11-118-012
17 cm / 6 3/4"

HIBBS
24 cm / 9 1/2"

HIBBS
24 cm / 9 1/2"

3 mm
11-117-003
11-118-003

5 mm
11-117-005
11-118-005

6 mm
11-117-006
11-118-006

8 mm
11-117-008
11-118-008

10 mm
11-117-010
11-118-010

12 mm
11-117-012
11-118-012

6 mm
11-119-006

13 mm
11-119-013

19 mm
11-119-019

25 mm
11-119-025

32 mm
11-119-032

6 mm
11-120-006

13 mm
11-120-013

19 mm
11-120-019

25 mm
11-120-025

32 mm
11-120-032

Bone Chisels and Gouges

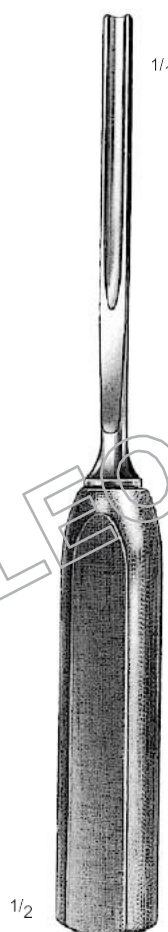
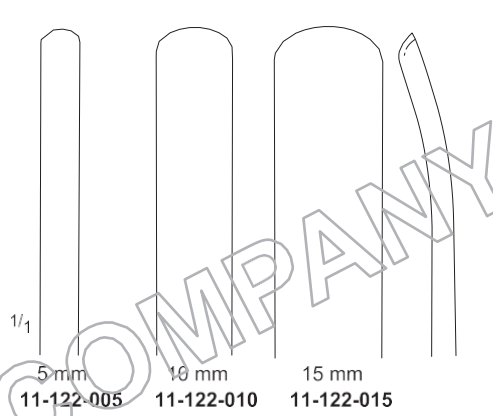
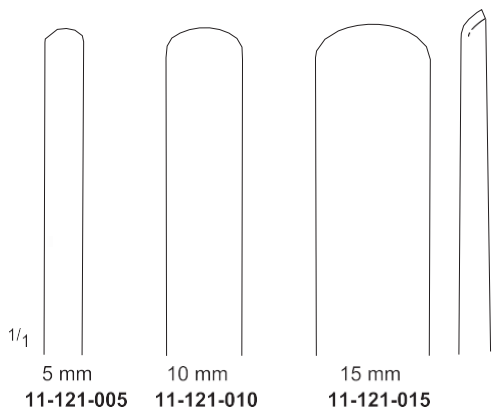

LEXER
25 cm / 10"
Handle from artificial wood



LEXER
25 cm / 10"
Handle from artificial wood

Bone Chisels and Gouges

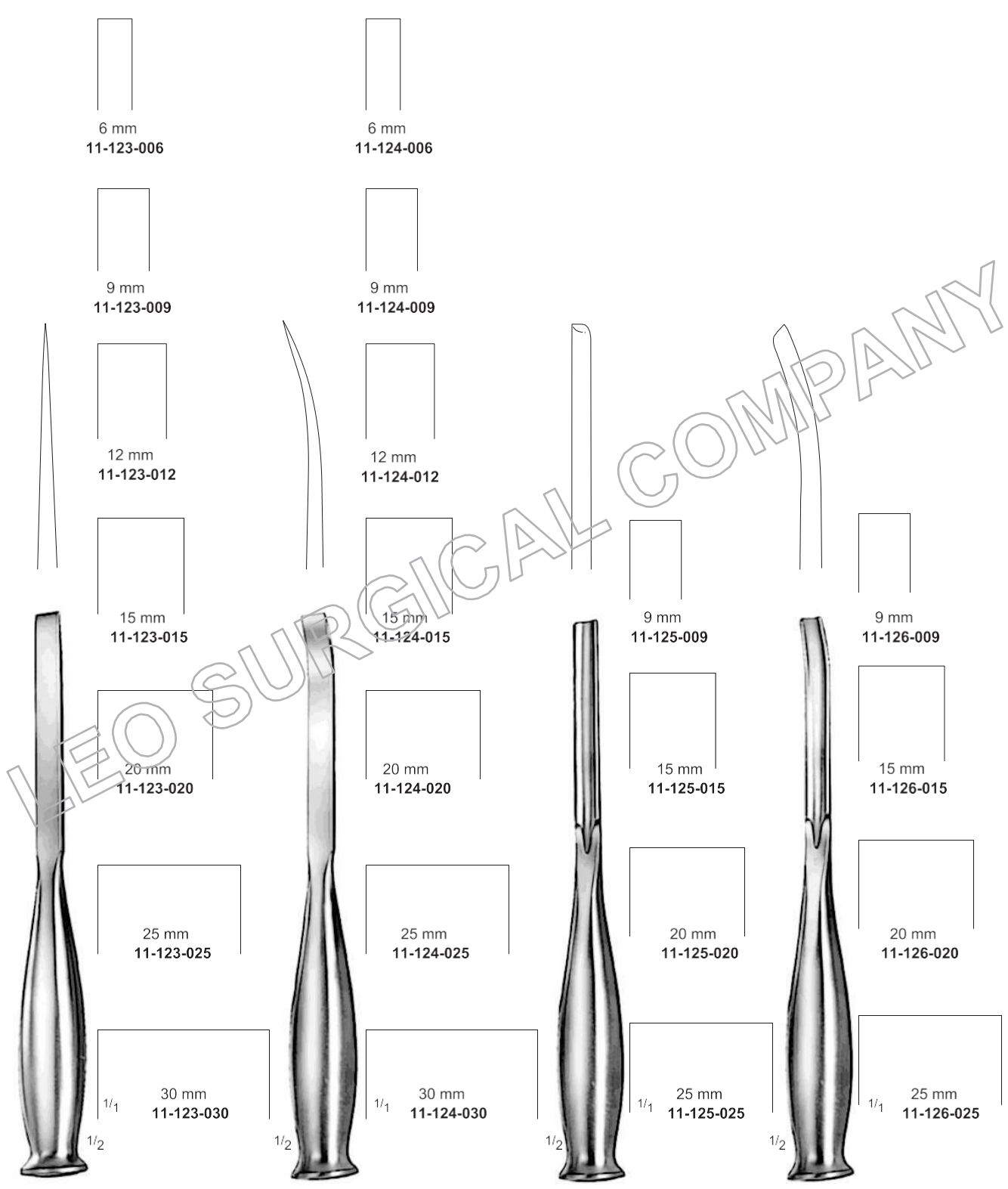

SMITH - PETERSON
20 cm / 8"

Bone Chisels and Gouges, Meniscotome Knives

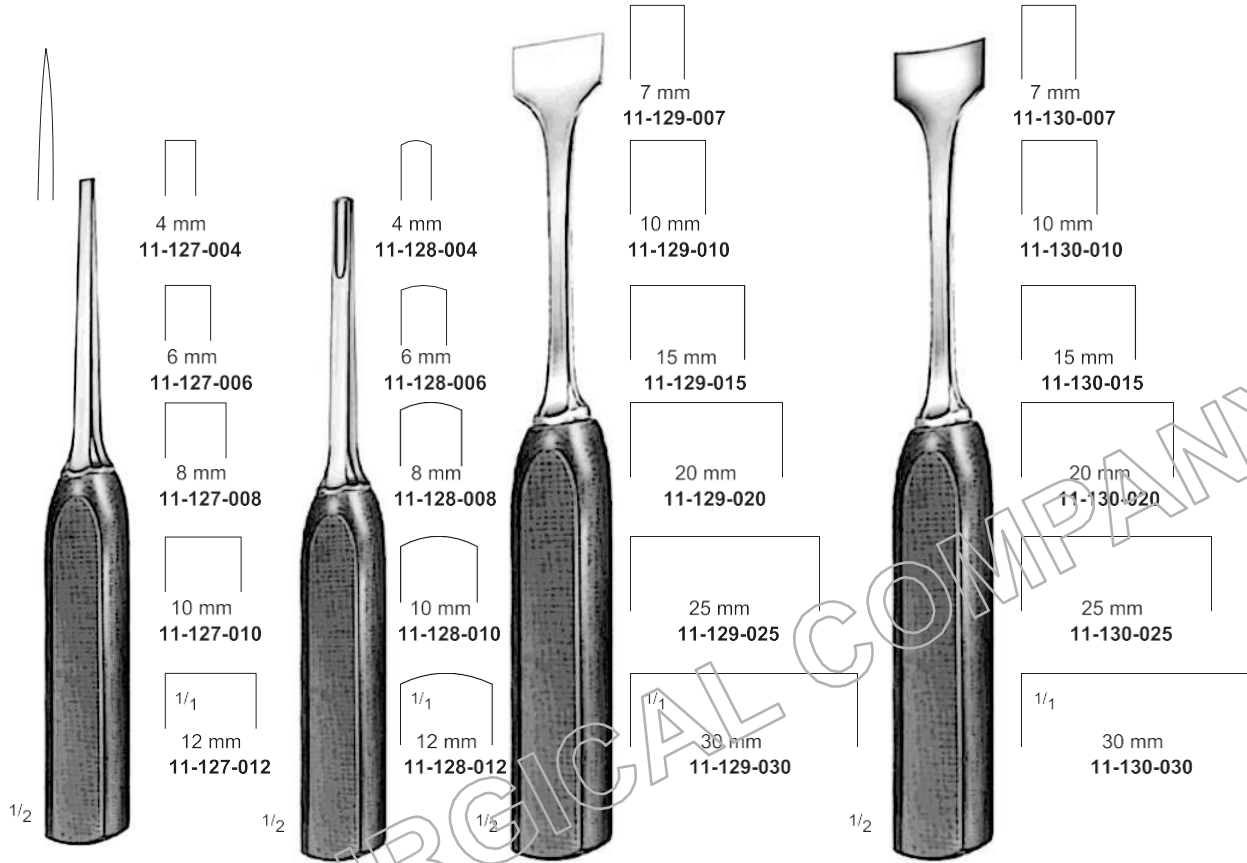

MINI-LEXER
 18 cm / 7"

LEXER
 22 cm / 8 3/4"

All handles from
 artificial wood



SMILLE
 17 cm / 6 3/4"

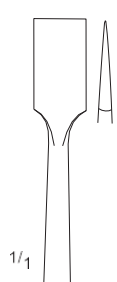

11-131-170

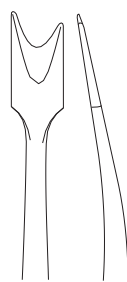

11-132-170

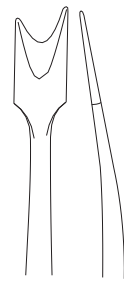

11-133-170

Bone Currettes



11-134-001
Fig. # 0000



11-134-002
Fig. # 000



11-134-003
Fig. # 00



11-134-004
Fig. # 0



11-134-005
Fig. # 1



11-134-006
Fig. # 2



11-134-007
Fig. # 3



11-134-008
Fig. # 4



11-134-009
Fig. # 5

1/1



11-134-009
Fig. # 5



11-135-001
Fig. # 0000



11-135-002
Fig. # 000



11-135-003
Fig. # 00



11-135-004
Fig. # 0



11-135-005
Fig. # 1

1/1



11-136-002
Fig. # 2



11-136-003
Fig. # 3



11-136-004
Fig. # 4



11-136-005
Fig. # 5



11-136-006
Fig. # 6



11-137-000
Fig. # 0



11-137-001
Fig. # 1



11-137-002
Fig. # 2



11-137-003
Fig. # 3



11-137-004
Fig. # 4

1/1



1/2

BRUNS
23 cm / 9"



1/2

BRUNS
27 cm / 10 3/4"



1/2

BRUNS
17 cm / 6 3/4"

All handles from
artificial wood

Bone Curettes

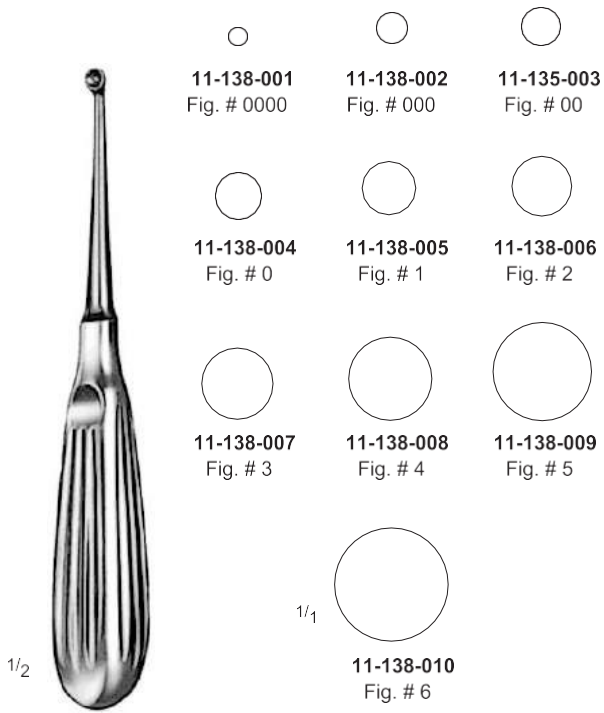

BRUNS
17 cm / 6 3/4"

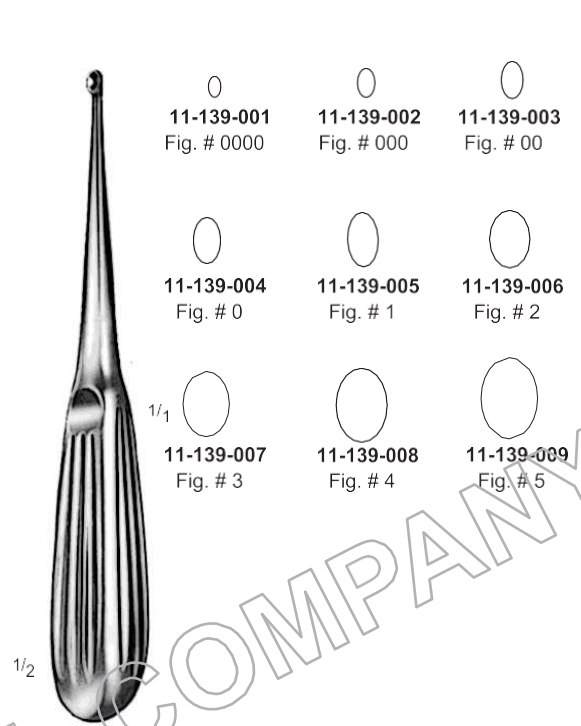

SPRATT
17 cm / 6 3/4"

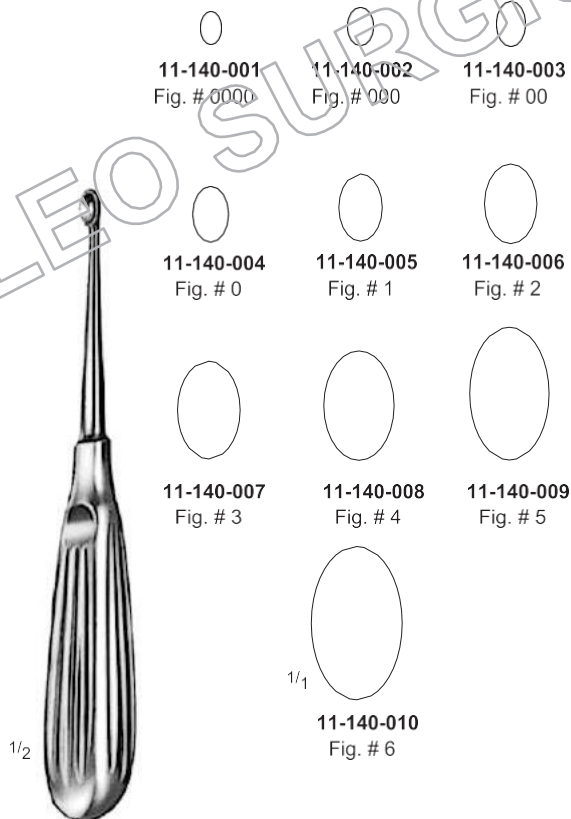

VOLKMANN
17 cm / 6 3/4"

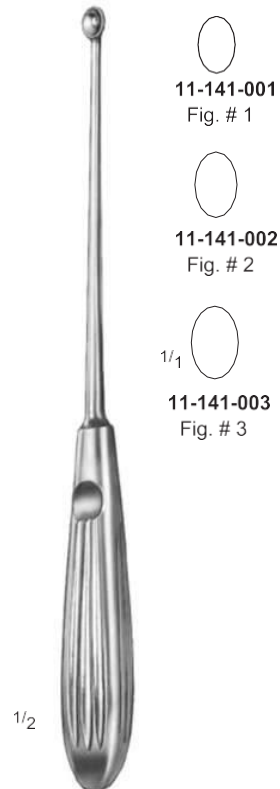











HALLE
21 cm / 8 1/4"

Bone Currettes









BRUNS-VOLKMAN
23 cm / 9"

- | | | | | |
|---|---|---|--|---|
|  |  |  |  |  |
| 11-142-001
Fig. # 0000 | 11-142-002
Fig. # 000 | 11-142-003
Fig. # 00 | 11-142-004
Fig. # 0 | 11-142-005
Fig. # 1 |
|  |  |  |  |  |
| 11-142-006
Fig. # 2 | 11-142-007
Fig. # 3 | 11-142-008
Fig. # 4 | 11-142-009
Fig. # 5 | 11-142-010
Fig. # 6 |









VOLKMAN

- | | | |
|---|---|---|
|  |  |  |
|  |  |  |
| 11-143-130
13 cm / 5" | 11-143-140
14 cm / 5 1/2" | 11-143-170
17 cm / 6 3/4" |



WILLIGER
13.5 cm / 5 1/4"

- | |
|---|
|  |
|  |
|  |
|  |
|  |
|  |



VOLKMAN
22 cm / 8 3/4"

- | |
|---|
|  |
|  |
|  |
|  |
|  |
|  |

11-145-001
Fig # 1

11-145-002
Fig # 2

11-145-003
Fig # 3

Bone Rongeurs

Upper side of
Jaw Open

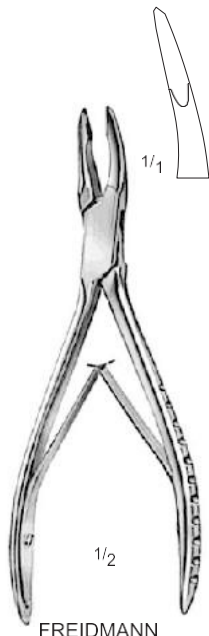

FREIDMANN
11-146-140
14 cm / 5 1/2"

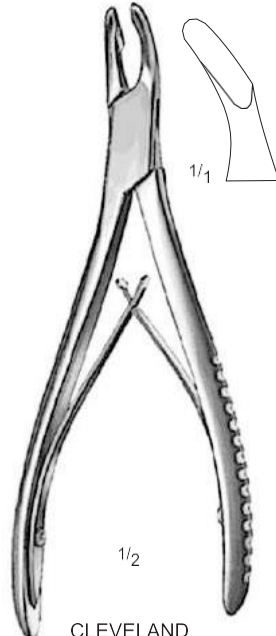

CLEVELAND
11-147-170
17 cm / 6 3/4"

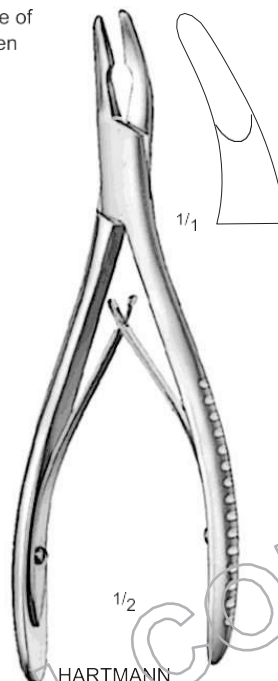

HARTMANN
11-148-190
19 cm / 7 1/2"



MEAD
11-149-140
14 cm / 5 1/2"
11-150-170
17 cm / 6 3/4"

20. 10.14
20. 10.17

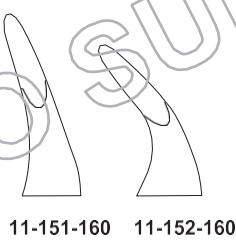

11-151-160

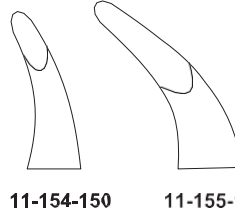

11-154-150

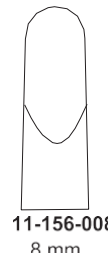

11-156-008
8 mm

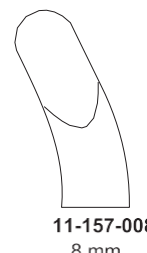

11-157-008
8 mm



BLUMENTHAL
16 cm / 6 1/4"

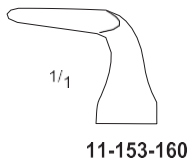

11-153-160

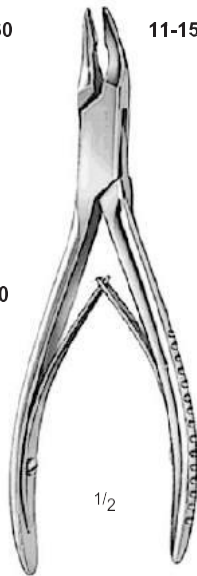

LUER
15 cm / 6"

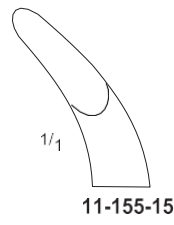

11-155-150

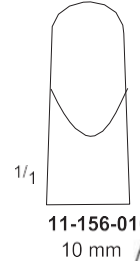

11-156-010
10 mm

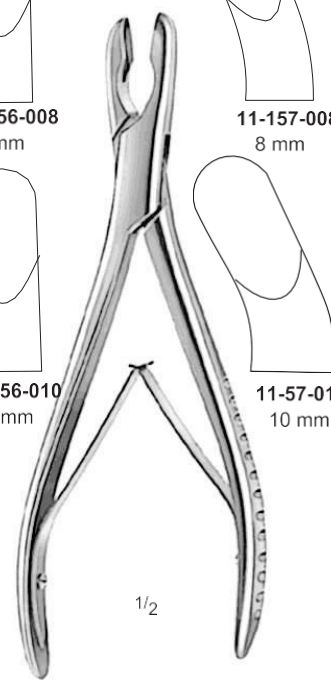

LUER
18 cm / 7"

11-57-010
10 mm

Bone Rongeurs

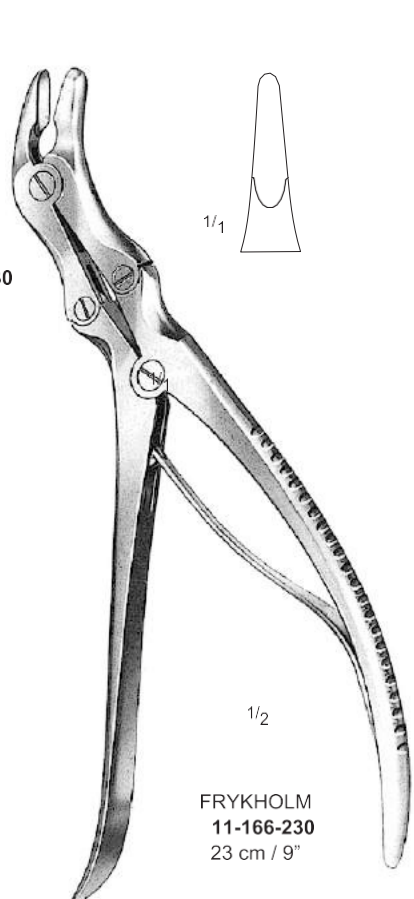
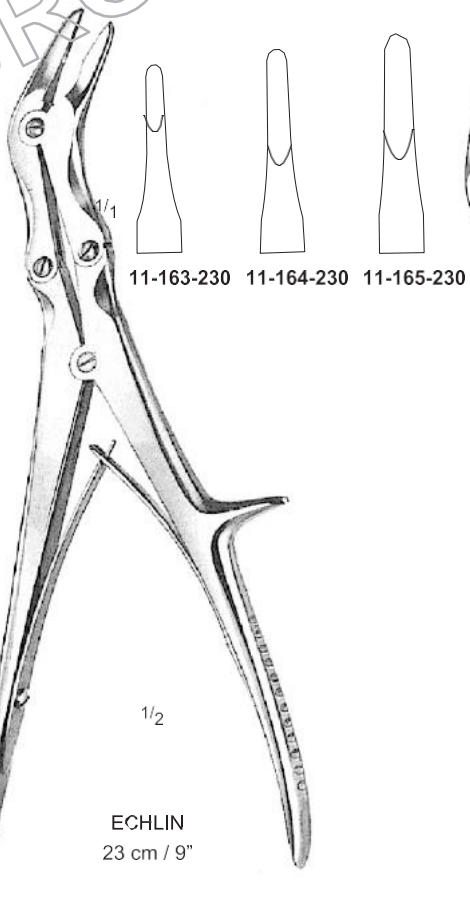
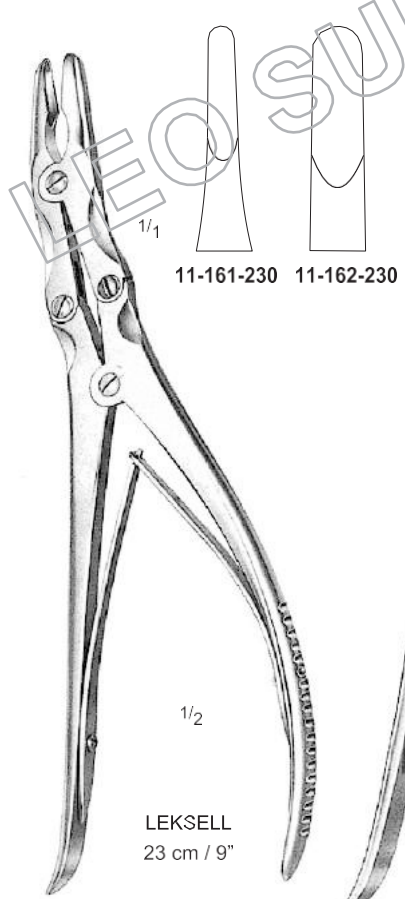
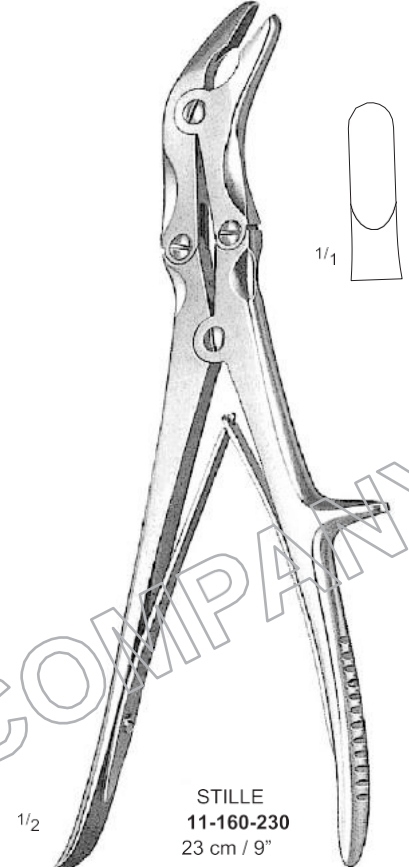
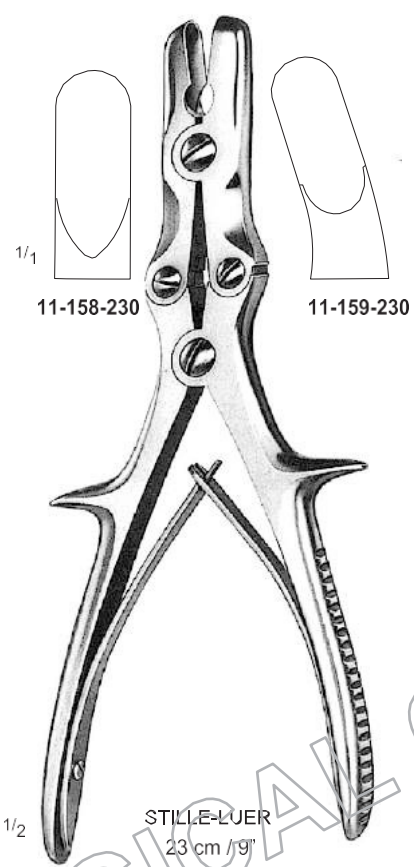
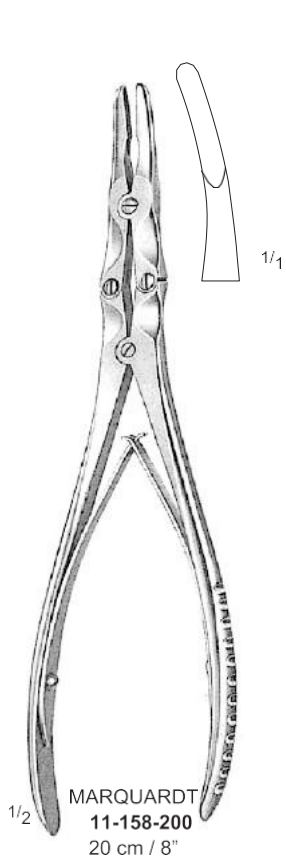

Bone Rongeurs

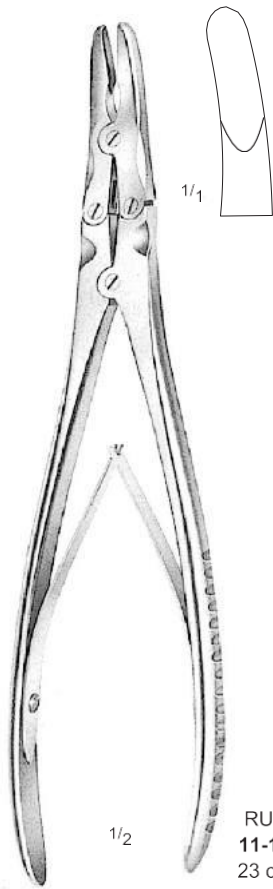

RUSKIN
11-167-230
23 cm / 9"

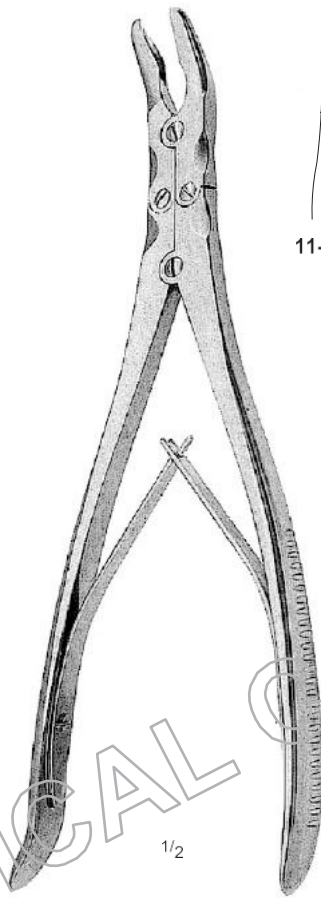

SMITH PETERSON
24 cm / 9 1/2"

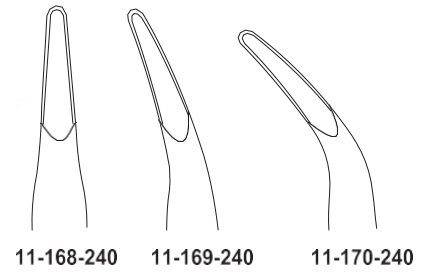

11-168-240 11-169-240 11-170-240

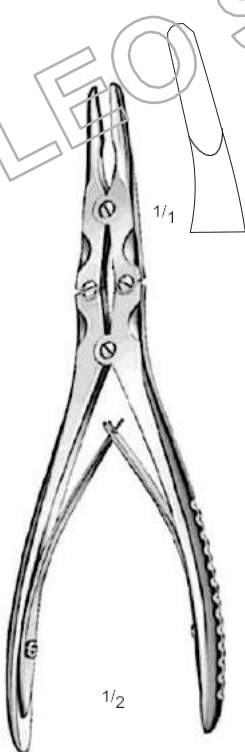

ZAUFAL-JANSEN
11-171-180

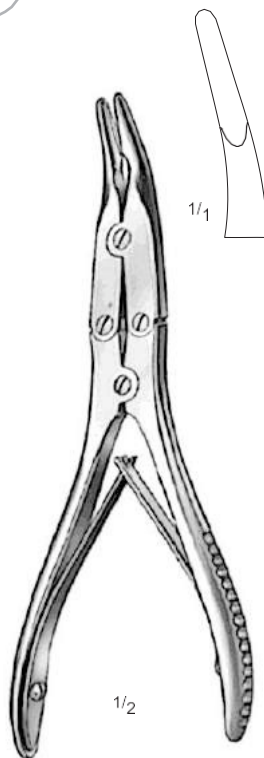

BEYER
11-172-180

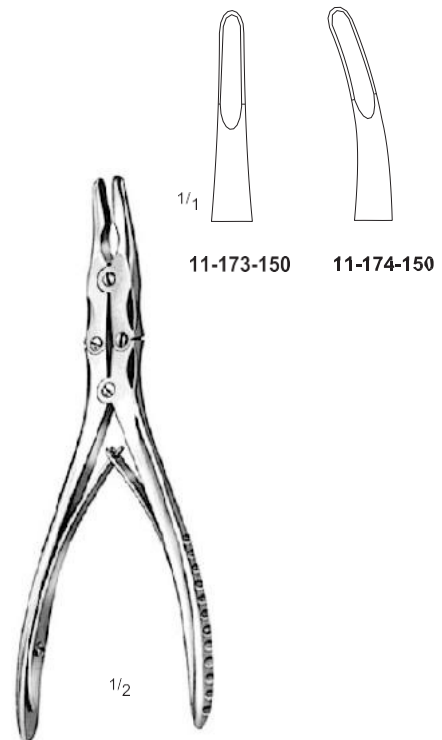

BOHLER

11-173-150 11-174-150

Bone Rongeurs

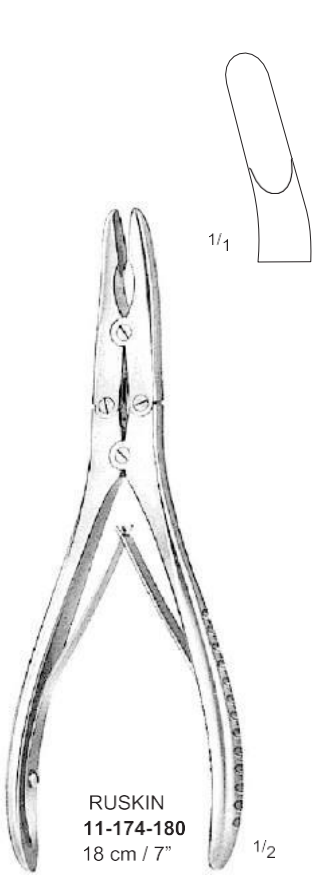

RUSKIN
 11-174-180
 18 cm / 7"

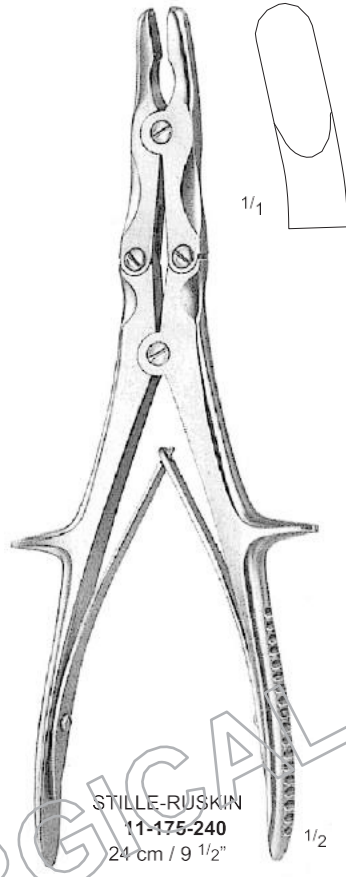

STILLE-RUSKIN
 11-175-240
 24 cm / 9 1/2"



11-176-230
 23 cm / 9"

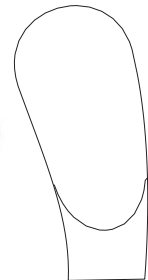

11-178-230
 23 cm / 9"

11-176-270
 27 cm / 10 1/2"

11-179-270
 27 cm / 10 1/2"

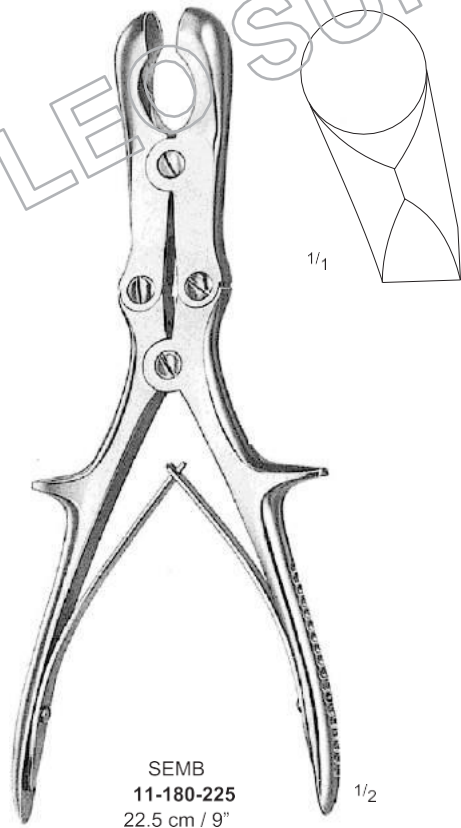

SEMB
 11-180-225
 22.5 cm / 9"

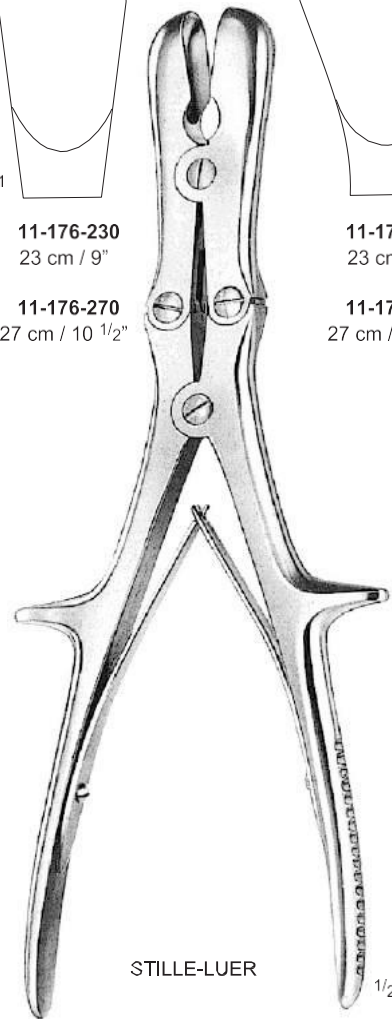

STILLE-LUER

1/2