

Retractors

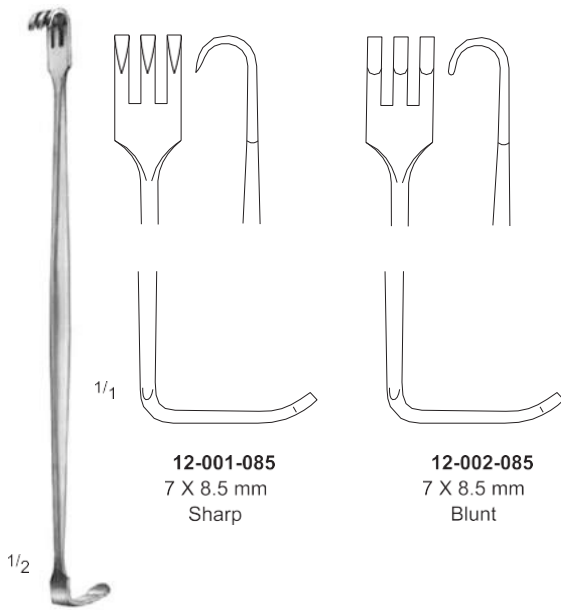

Hooks and Retractors



12-001-085
7 X 8.5 mm
Sharp

12-002-085
7 X 8.5 mm
Blunt

SEN MILLER
16 cm / 6 1/4"

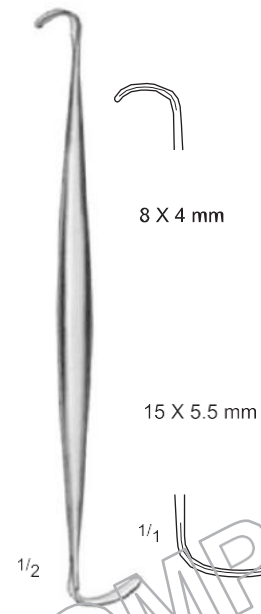

8 X 4 mm

15 X 5.5 mm

RAGNELL - DAVIS
12-003-160
16 cm / 6 1/4"

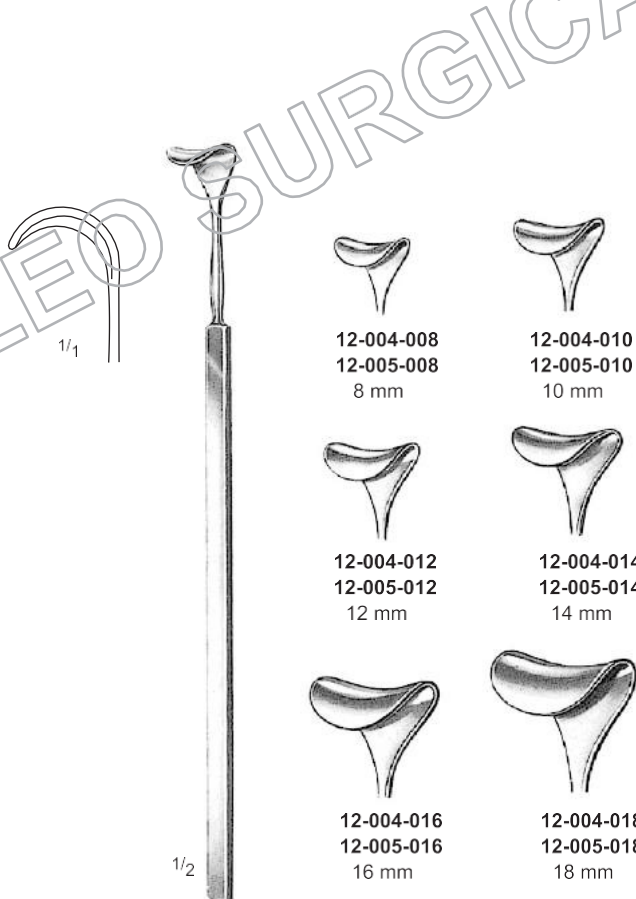

12-004-008
12-005-008
8 mm

12-004-010
12-005-010
10 mm

12-004-012
12-005-012
12 mm

12-004-014
12-005-014
14 mm

12-004-016
12-005-016
16 mm

12-004-018
12-005-018
18 mm

CUSHING
12-004-008 - 12-004-018
20 cm / 8"

CUSHING
12-005-008 - 12-005-018
24 cm / 9 1/2"

Hooks and Retractors

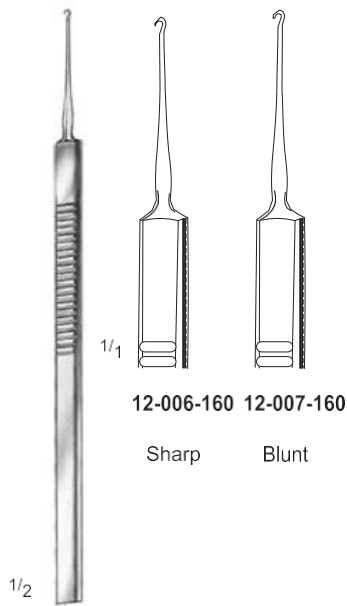

12-006-160 12-007-160
Sharp Blunt

GRAEFE
16 cm / 6 1/4"

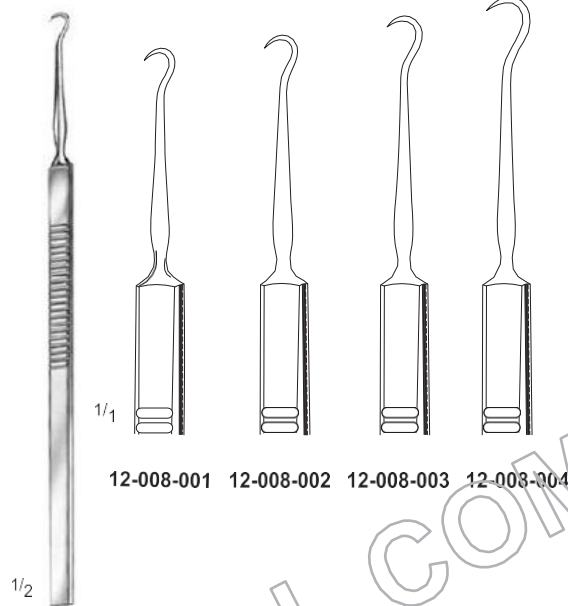

12-008-001 12-008-002 12-008-003 12-008-004

GILLIES
16 cm / 6 1/4"

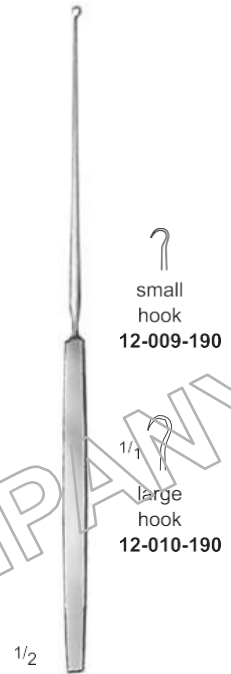

small hook
12-009-190
large hook
12-010-190

GILLIES
19 cm / 7 1/2"

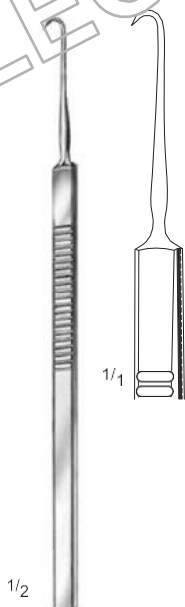

O'CONNOR
12-011-160
16 cm / 6 1/4"

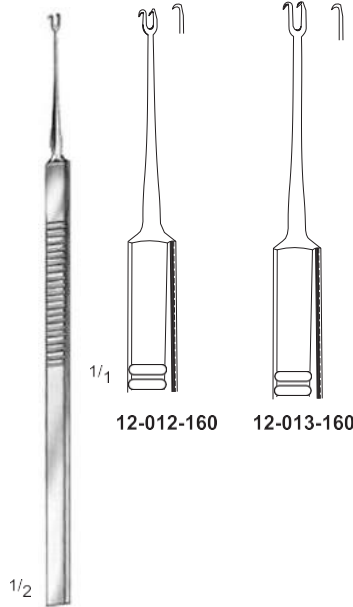

GUTHRIE
16 cm / 6 1/4"



12-014-160
16 cm / 6 1/4"

LEO SURGICAL COMPANY

Retractors

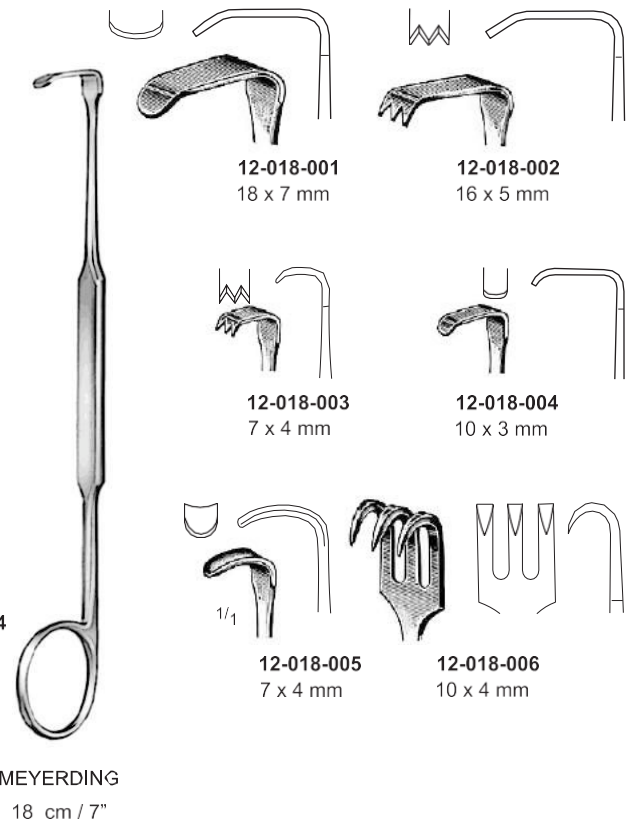
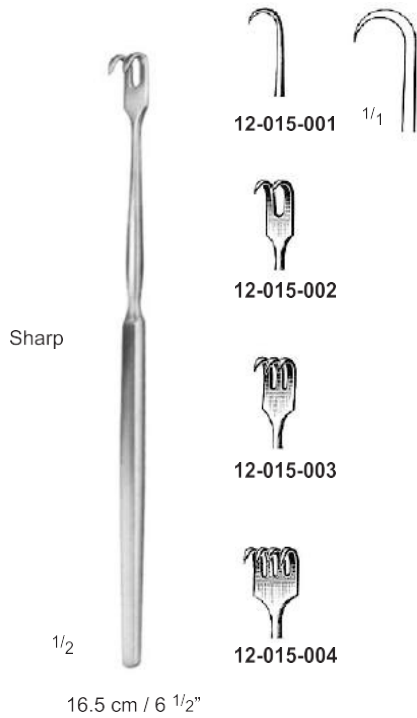

Retractors

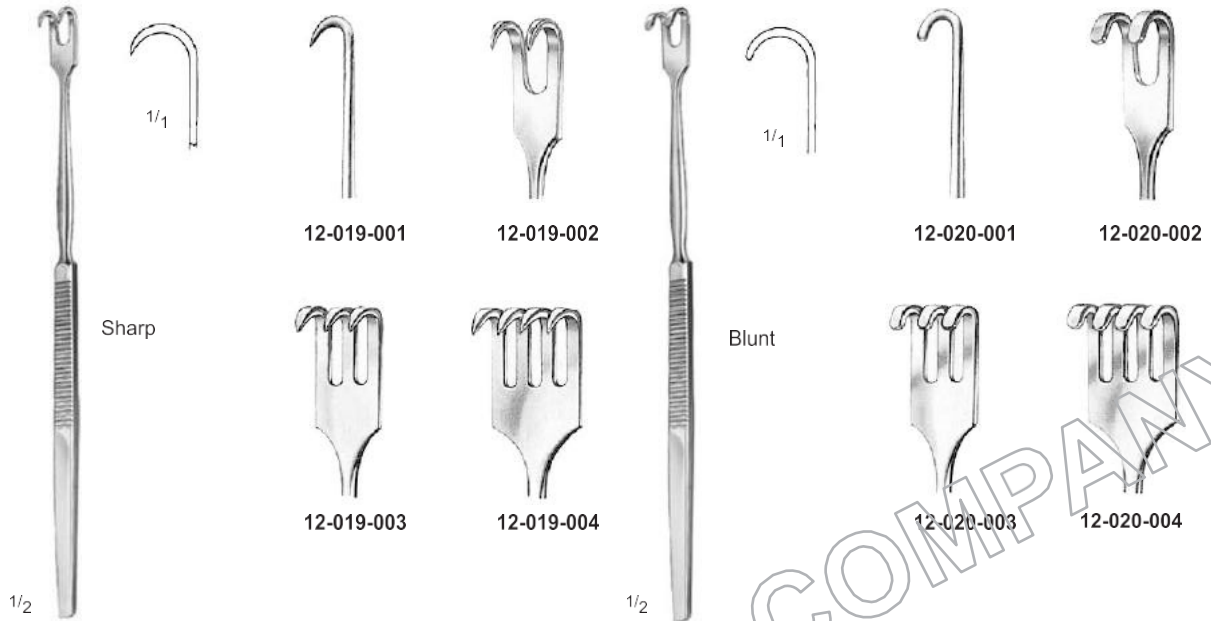

21. 27.01—21. 27.04
16 cm / 6 1/4"

21. 27.11—21. 27.14
16 cm / 6 1/4"

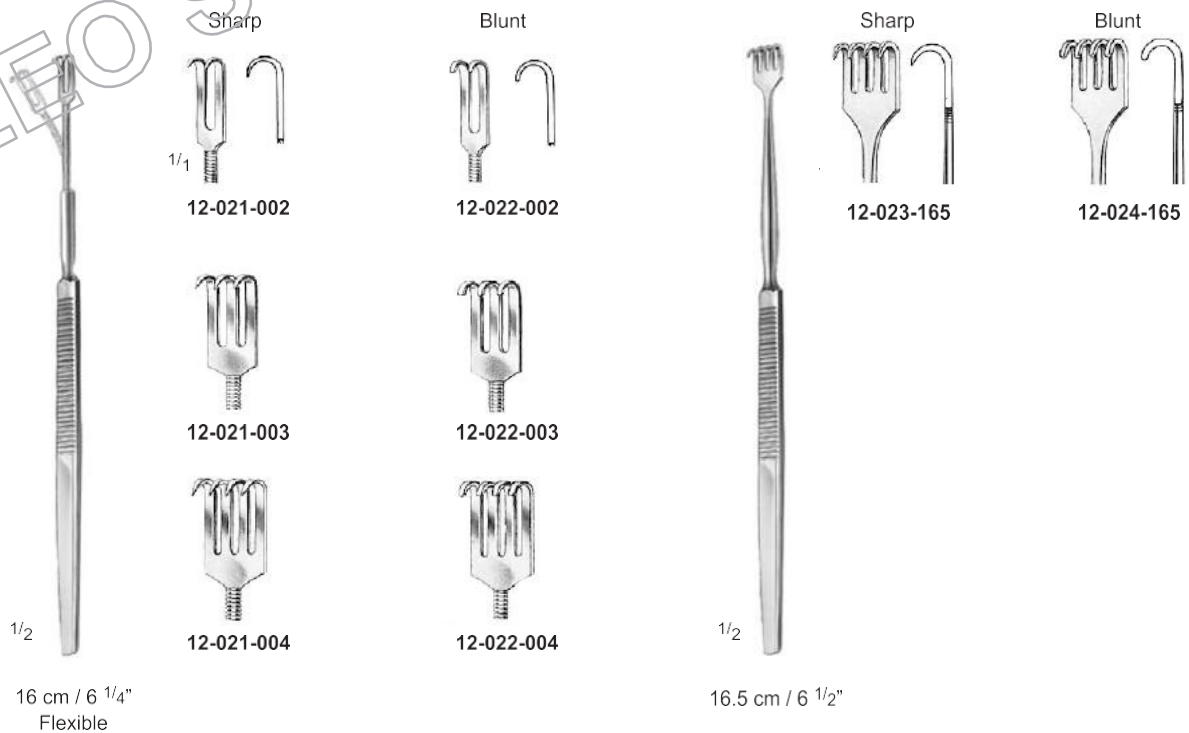

16 cm / 6 1/4"
Flexible

16.5 cm / 6 1/2"

Abdominal Spatulas, Ribbon Retractors

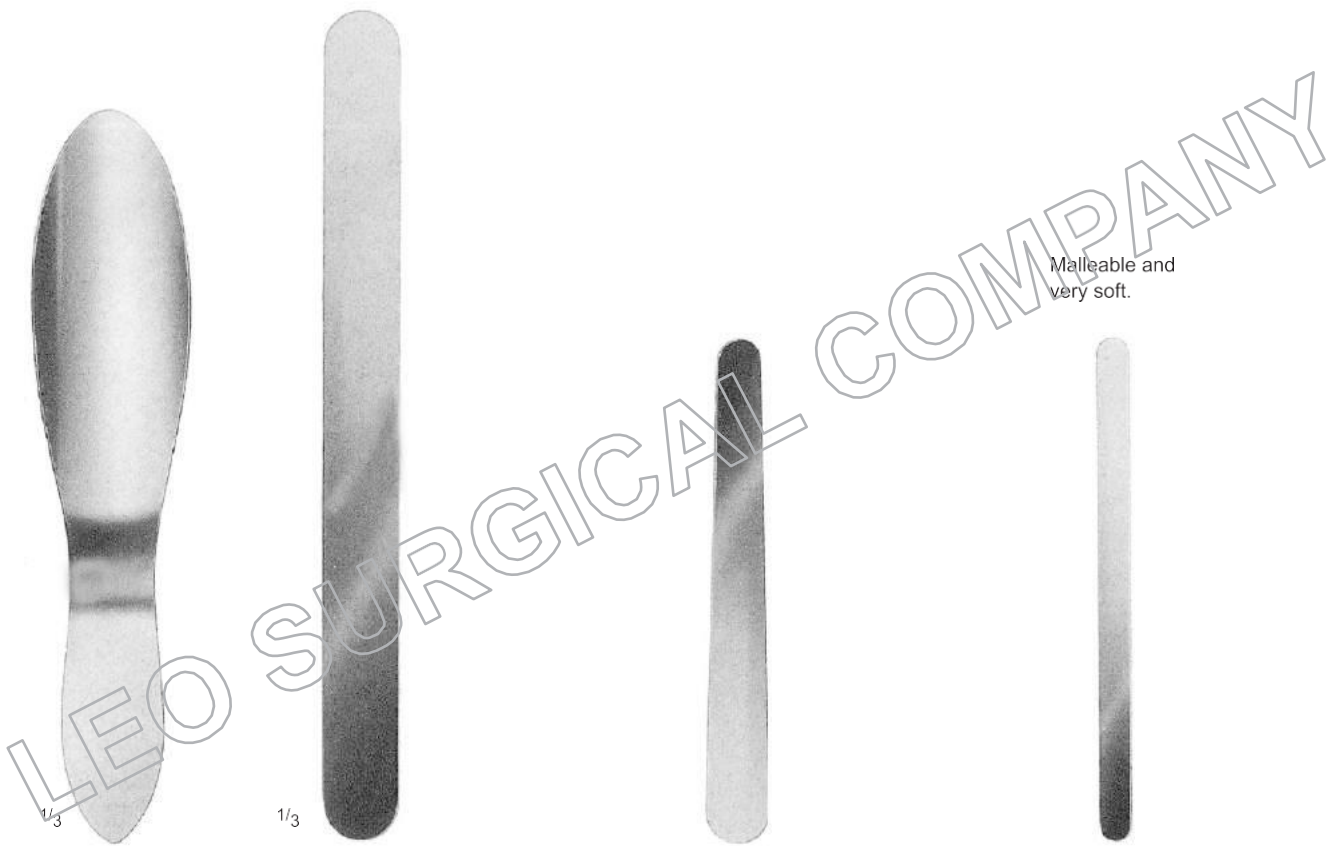

REVERDIN
12-025-280
28 cm / 11"
45 x 60 mm

OCHSNER
12-026-030 30 mm
12-026-040 40 mm
12-026-050 50 mm
33 cm / 13"

Flexible

HABERER
12-027-200
20 cm / 8", 17/25 mm
12-027-280
28 cm / 11", 25/30 mm
12-027-300
30 cm / 12", 37/45 mm

Flexible

12-028-006 – 6 x 200 mm
12-028-010 – 10 x 200 mm
12-028-012 – 12 x 200 mm
12-028-017 – 17 x 200 mm
12-028-020 – 20 x 200 mm
12-028-025 – 25 x 200 mm
12-028-027 – 27 x 250 mm
12-028-035 – 35 x 250 mm

Retractors

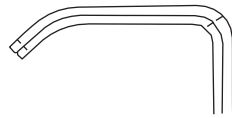
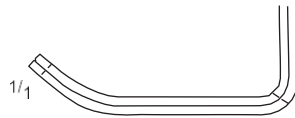

Fig. 2 = 30 x 10 mm
Fig. 1 = 26 x 10 mm

Fig. 1 = 30 x 13 mm
Fig. 2 = 34 x 13 mm



FARABEU
12-029-120 – Set of 2
12 cm / 4 3/4"

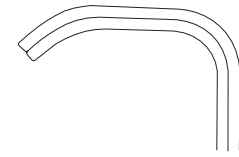
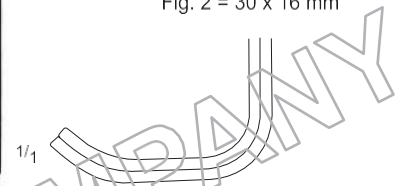

Fig. 2 = 27 x 16 mm
Fig. 1 = 23 x 16 mm

Fig. 1 = 26 x 16 mm
Fig. 2 = 30 x 16 mm



FARABEU
12-030-150 – Set of 2
15 cm / 6"

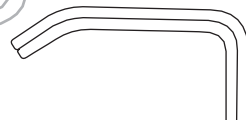
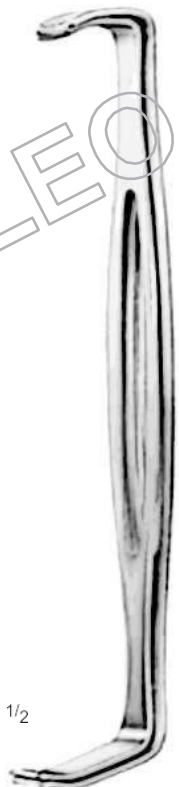

Fig. 2 = 25 x 15 mm
Fig. 1 = 21 x 15 mm

Fig. 1 = 40 x 15 mm
Fig. 2 = 45 x 15 mm



PARKER - LANGENBECK
12-031-210 – Set of 2
21 cm / 8 1/4"

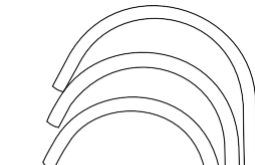
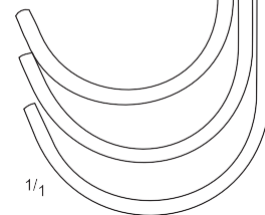

Fig. 1 = 24 x 20 mm
Fig. 2 = 29 x 26 mm
Fig. 3 = 33 x 29 mm

Fig. 1 = 30 x 28 mm
Fig. 2 = 36 x 36 mm
Fig. 3 = 38 x 43 mm



ROUX
12-032-150 – Fig 1 = 15 cm / 6"
12-032-160 – Fig 2 = 16 cm / 6 1/4"
12-032-170 – Fig 3 = 17 cm / 6 3/4"

Set of 3
21. 49.10

Retractors, Hooks

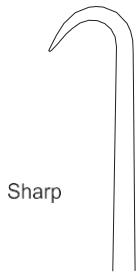

Sharp

12-033-001

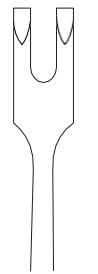

12-033-002

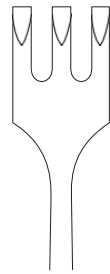

12-033-003

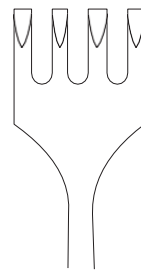

12-033-004

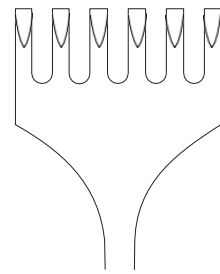

12-033-005

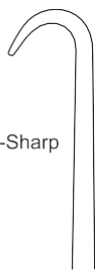

Semi-Sharp

12-034-001

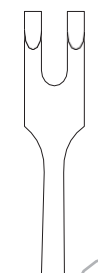

12-034-002

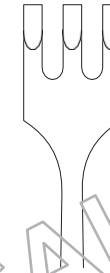

12-034-003

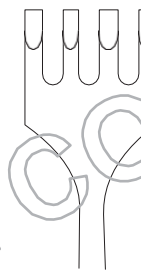

12-034-004

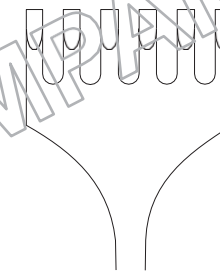

12-034-005



Blunt

1/4

12-035-001

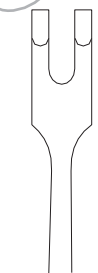

12-035-002



12-035-003

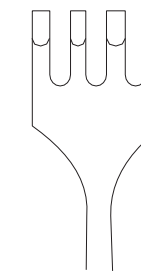

12-035-004

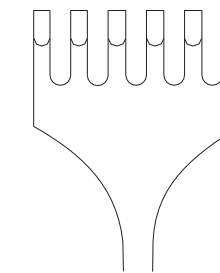

12-035-005



1/2

VOLKMANN
22 cm / 8 3/4"

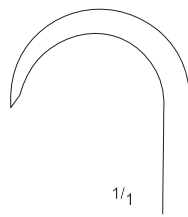

1/4

12-036-220
22 cm / 8 3/4"

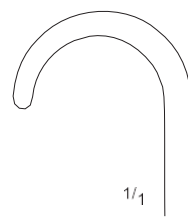

1/4

12-037-220
22 cm / 8 3/4"

Retractors

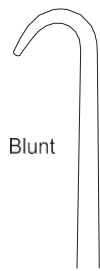

Blunt

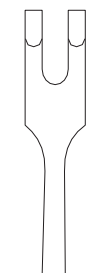

12-038-002

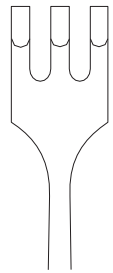

12-038-003

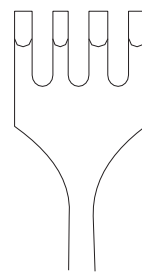

12-038-004

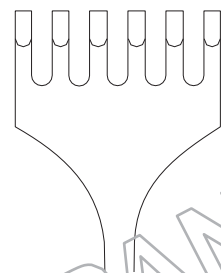

12-038-005

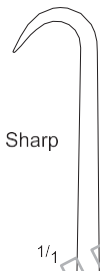

Sharp

1/1

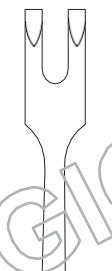

12-039-002



12-039-003

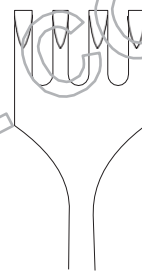

12-039-004

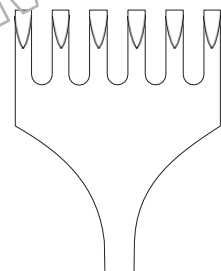

12-039-005

1/2

VOLKMANN
21.5 cm / 8 1/2"

Retractors

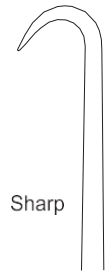

Sharp

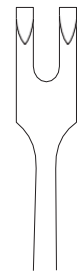

12-040-002

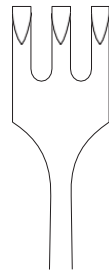

12-040-003

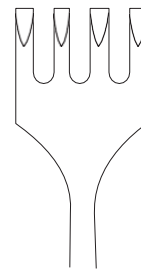

12-040-004

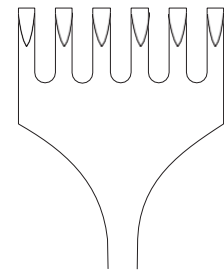

12-040-005



Blunt

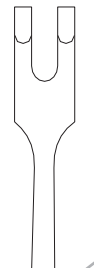

12-041-002

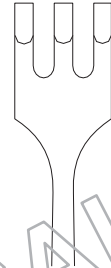

12-041-003

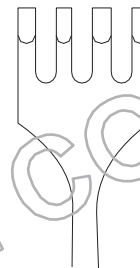

12-041-004

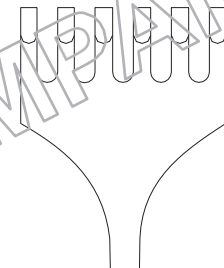

12-041-005

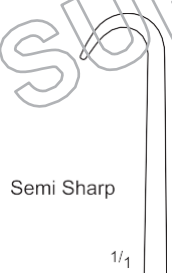

Semi Sharp

1/1

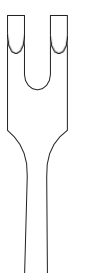

12-042-002

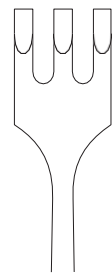

12-042-003

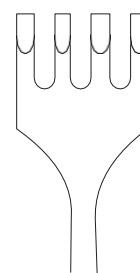

12-042-004

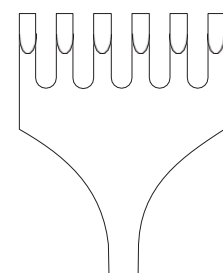

12-042-005



1/2

KOCHER
22 cm / 8 3/4"

Retractors

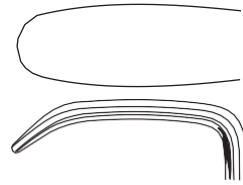

12-043-001
30 x 11 mm

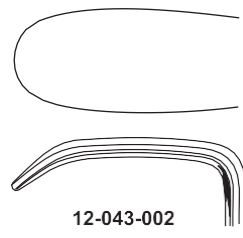

12-043-002
30 x 14 mm



12-043-003
30 x 16 mm

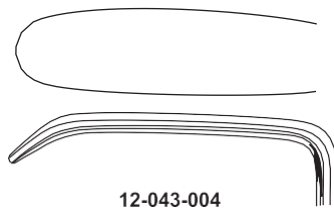

12-043-004
40 x 11 mm

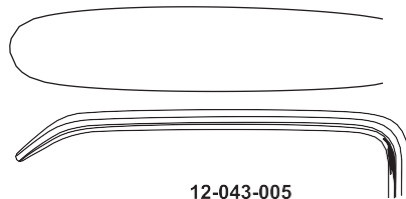

12-043-005
50 x 11 mm



1/2

LANGENBECK
21 cm / 8 1/4"

LEO SURGICAL COMPANY

Retractors

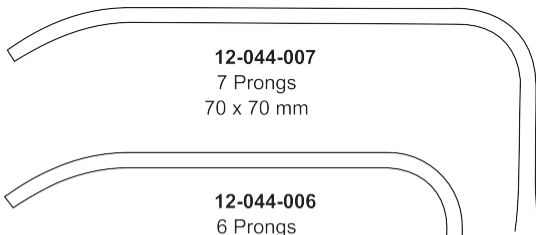

12-044-007
7 Prongs
70 x 70 mm

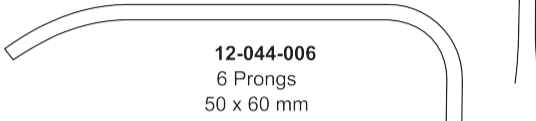

12-044-006
6 Prongs
50 x 60 mm

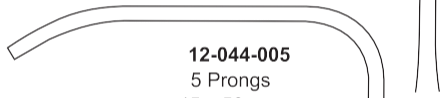

12-044-005
5 Prongs
45 x 50 mm

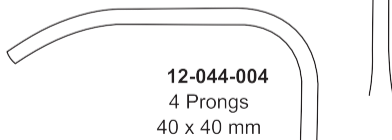

12-044-004
4 Prongs
40 x 40 mm



1/1



1/2

ISRAEL
25 cm / 10"



12-045-007
7 x 20 mm

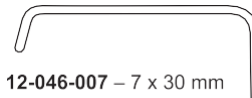

12-046-007 – 7 x 30 mm
12-046-010 – 10 x 30 mm
12-046-015 – 15 x 30 mm
12-046-020 – 20 x 30 mm

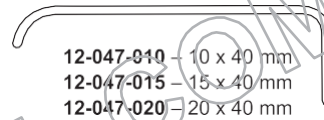

12-047-010 – 10 x 40 mm
12-047-015 – 15 x 40 mm
12-047-020 – 20 x 40 mm



12-048-020 – 20 x 45 mm

1/2

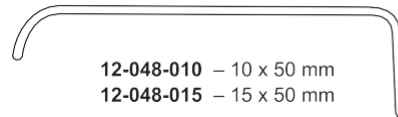

12-048-010 – 10 x 50 mm
12-048-015 – 15 x 50 mm

LANGENBECK-KOCHER
21 cm / 8 1/4"

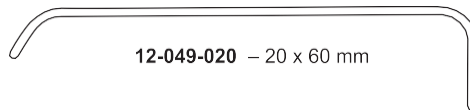

12-049-020 – 20 x 60 mm

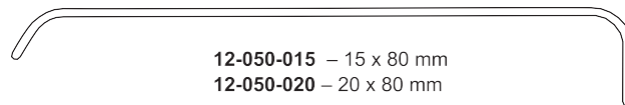

12-050-015 – 15 x 80 mm
12-050-020 – 20 x 80 mm

1/1

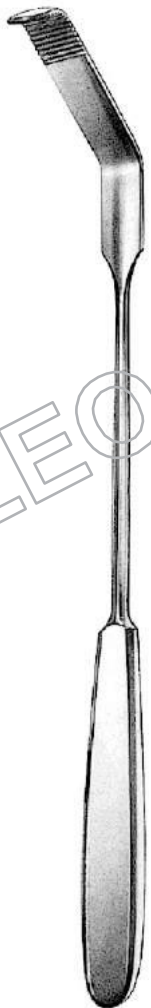

ZENKER

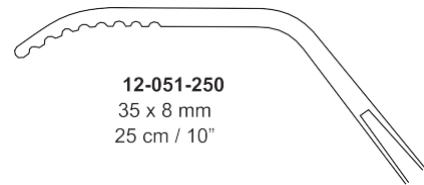

12-051-250
35 x 8 mm
25 cm / 10"

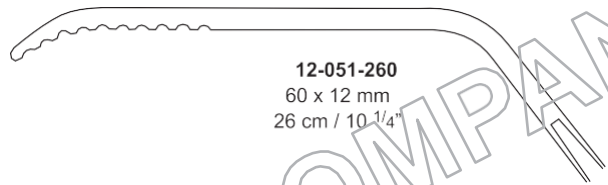

12-051-260
60 x 12 mm
26 cm / 10 1/4"

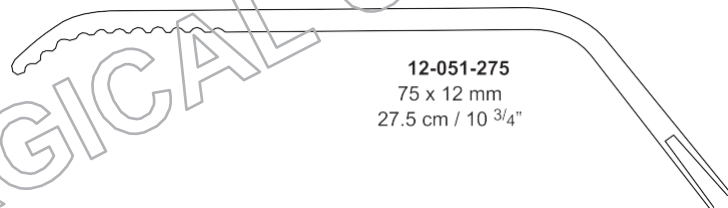

12-051-275
75 x 12 mm
27.5 cm / 10 3/4"

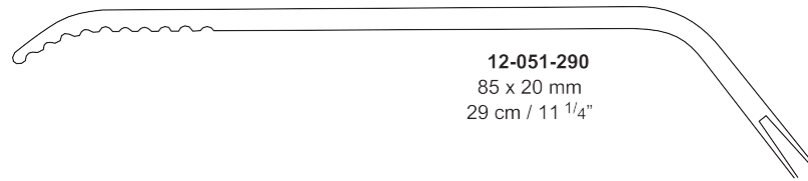

12-051-290
85 x 20 mm
29 cm / 11 1/4"

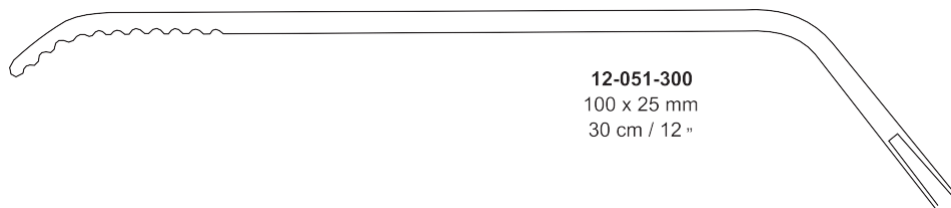

12-051-300
100 x 25 mm
30 cm / 12"

LEO SURGICAL COMPANY

Retractors

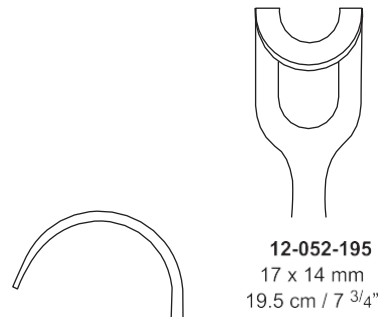

MIDDELDORPF

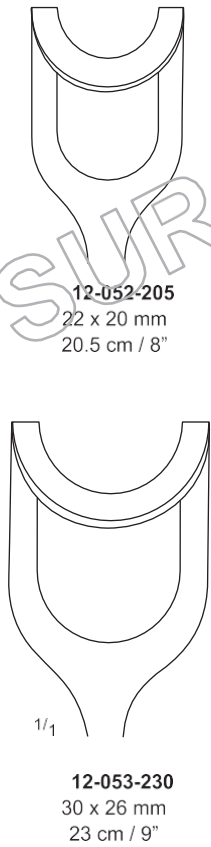

MIDDELDROPF
27.5 cm / 10 3/4"

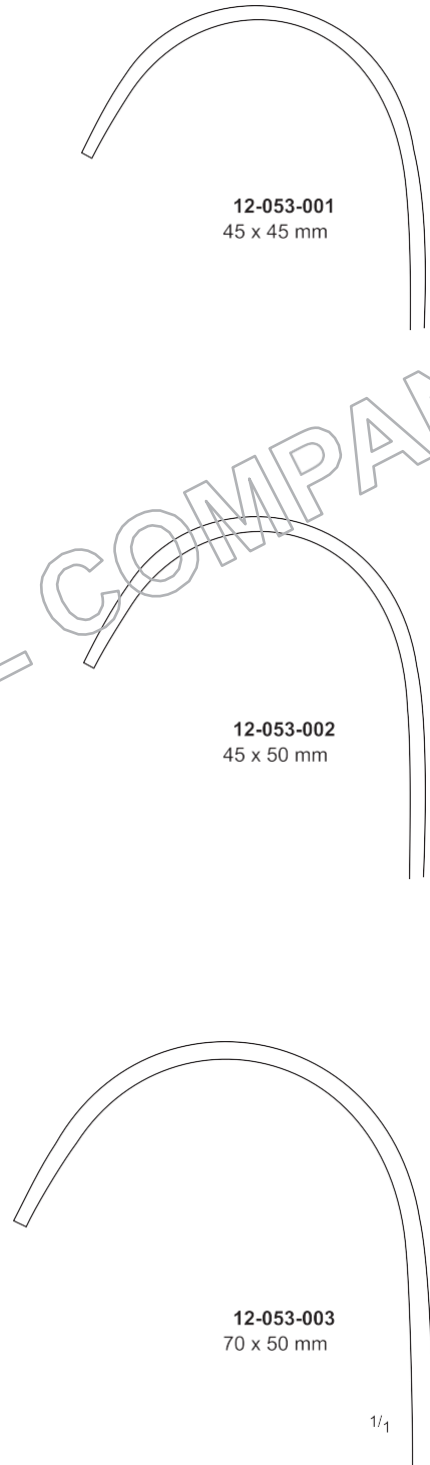

12-053-003
70 x 50 mm

Retractors

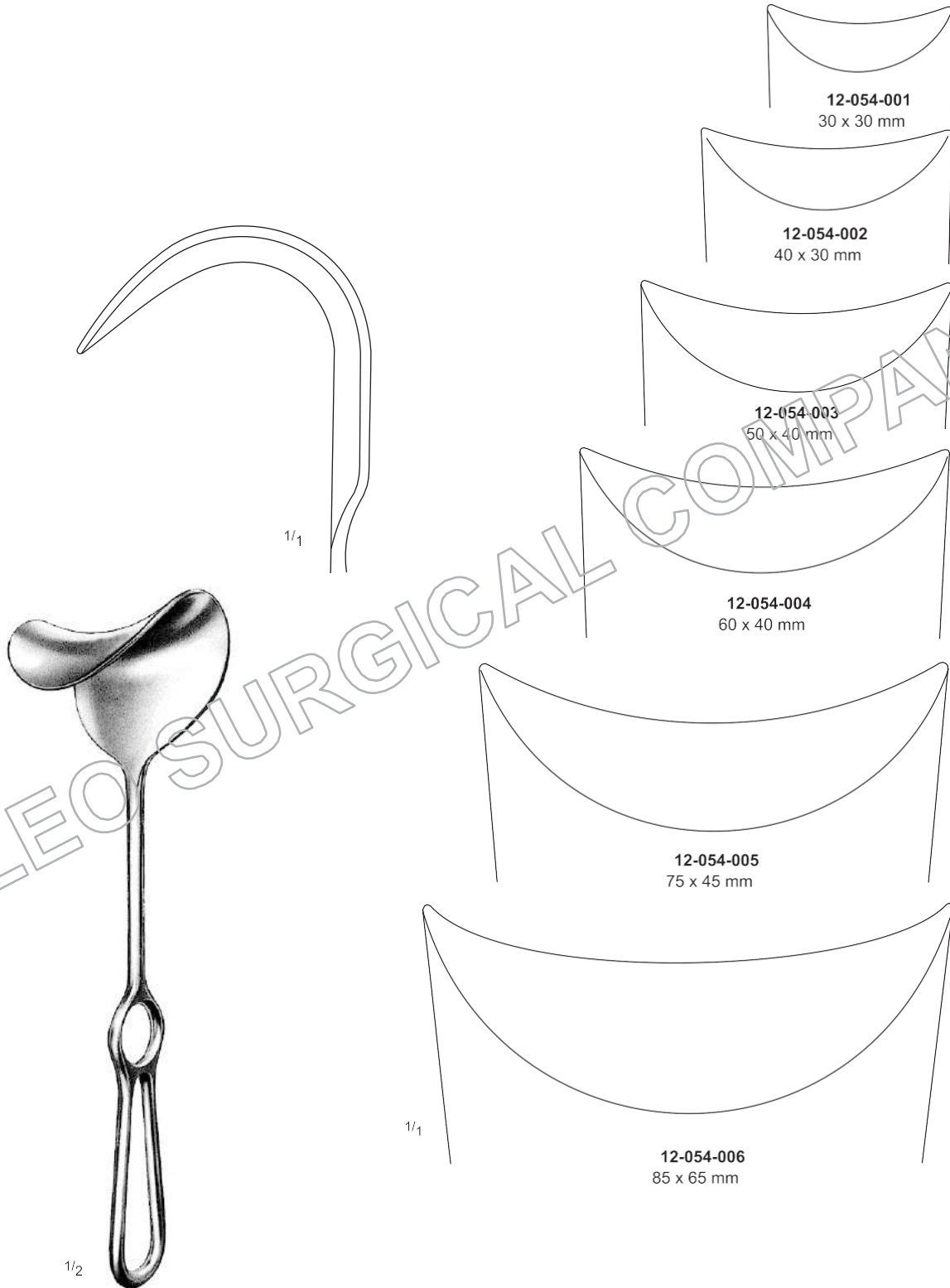

FRITSCH
23 cm / 9"

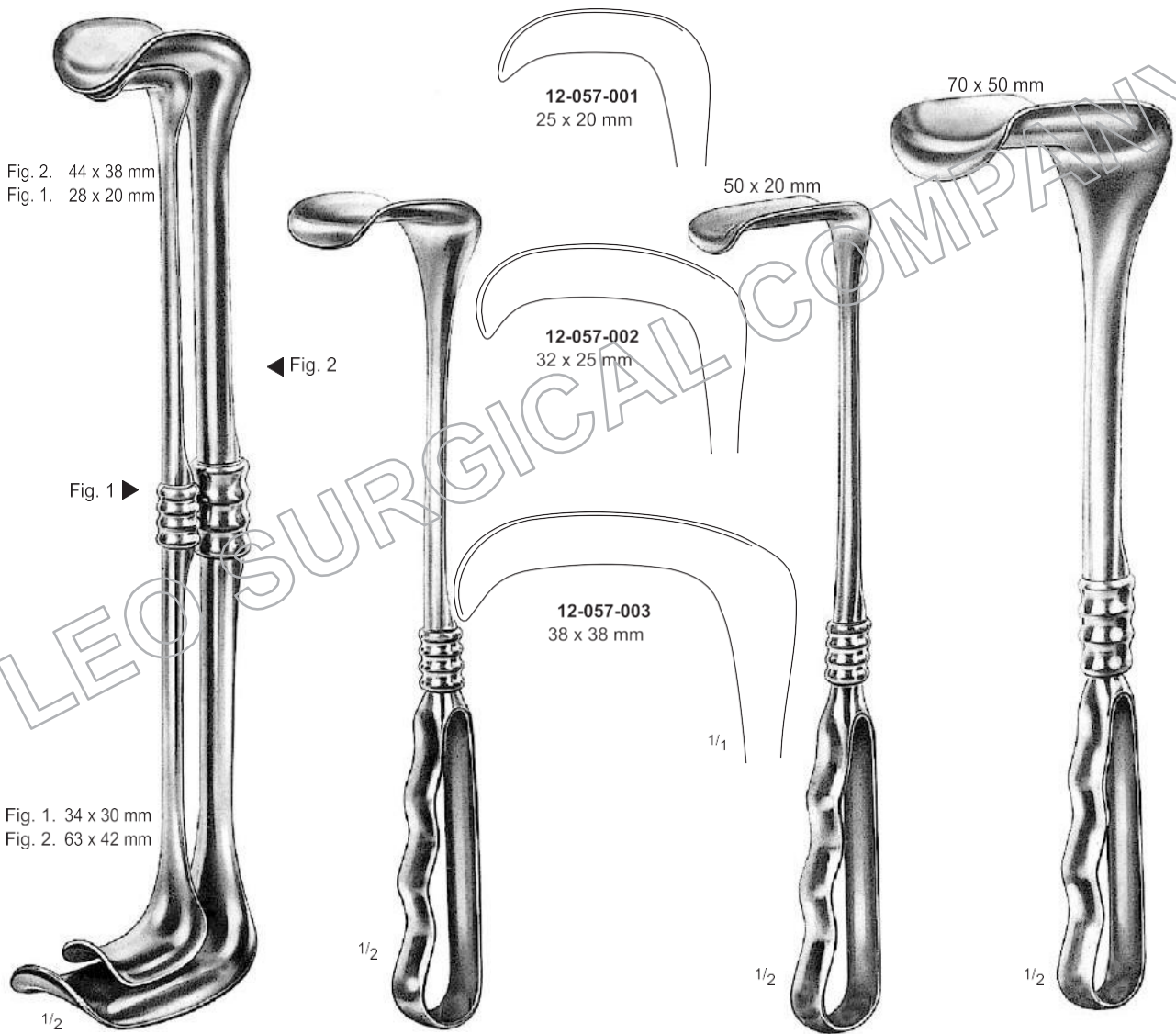

Fig. 2. 44 x 38 mm
Fig. 1. 28 x 20 mm

12-057-001
25 x 20 mm

50 x 20 mm

70 x 50 mm

◀ Fig. 2

12-057-002
32 x 25 mm

Fig. 1 ▶

12-057-003
38 x 38 mm

Fig. 1. 34 x 30 mm
Fig. 2. 63 x 42 mm

1/2

1/1

1/2

1/2

RICHARDSON-EASTMAN
12-055-000
complete set

RICHARDSON
24 cm / 9 1/2"

RICHARDSON
12-058-240
24 cm / 9 1/2"

KELLY
12-059-260
26 cm / 10 1/4"

12-056-001 Fig 1 = 26 cm / 10 1/4"
12-056-002 Fig 2 = 28 cm / 11"

Retractors

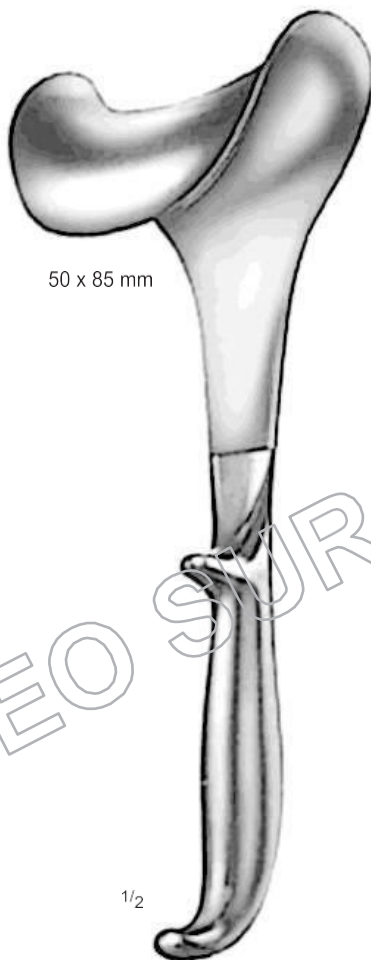
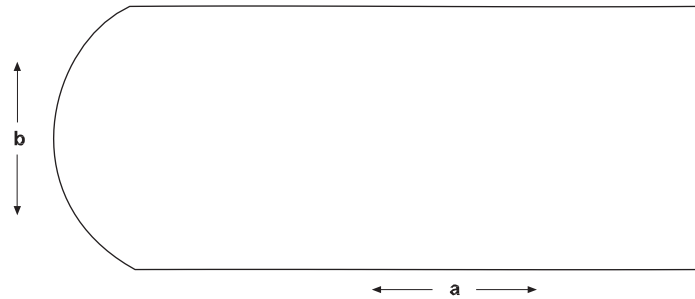

50 x 85 mm

1/2

DOYEN
12-060-240
24 cm / 9 1/2"



1/2

DOYEN
24 cm / 9 1/2"

a mm	b mm	Slightly Concave	Medium Hollow
55	35	12-061-001	12-062-001
85	35	12-061-002	12-062-002
115	35	12-061-003	12-062-003
55	45	12-061-004	12-062-004
85	45	12-061-005	12-062-005
115	45	12-061-006	12-062-006
160	45	12-061-007	12-062-007
55	60	12-061-008	12-062-008
85	60	12-061-009	12-062-009
115	60	12-061-010	12-062-010
160	60	12-061-011	12-062-011

Retractors

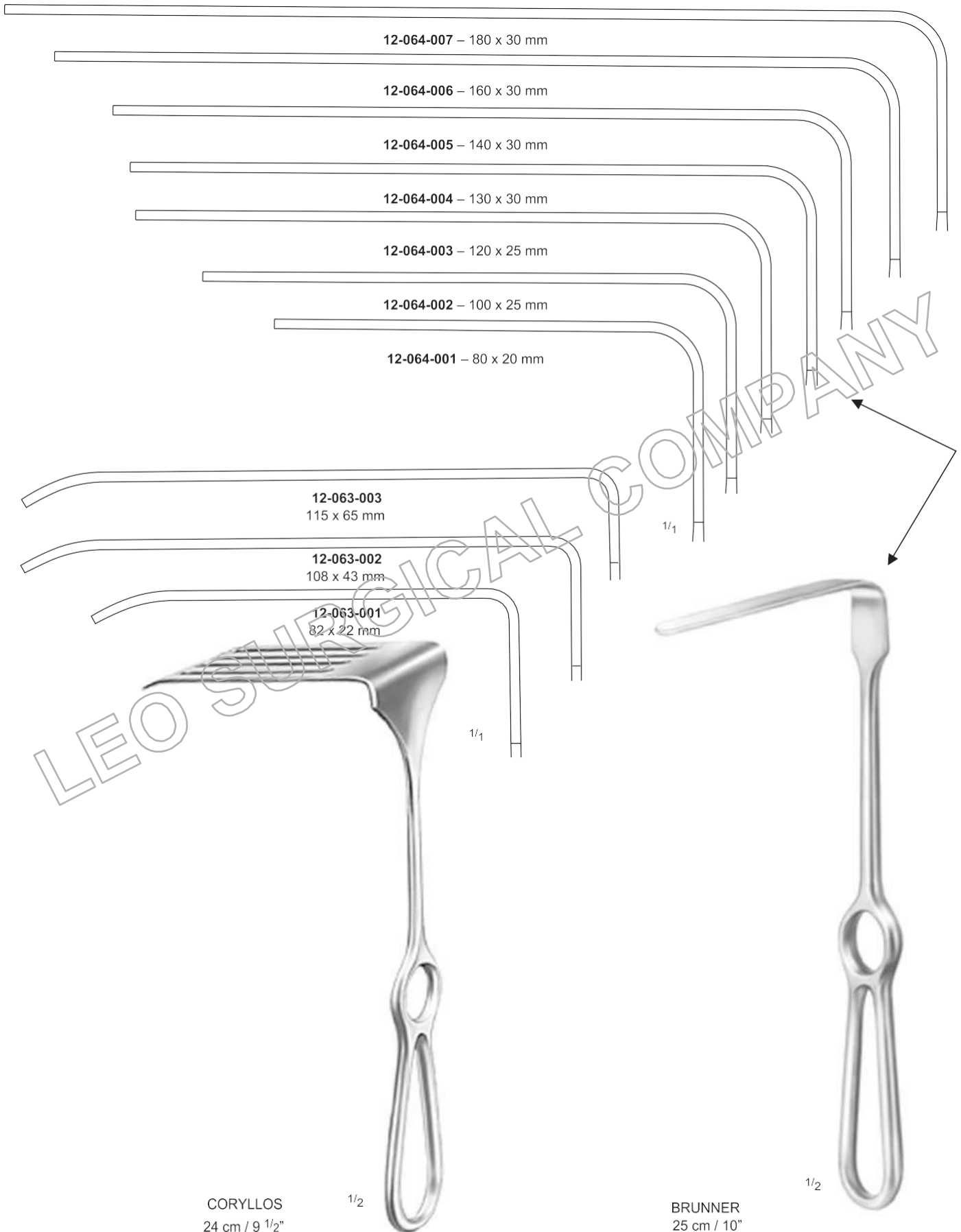

Splanchnic Retractors

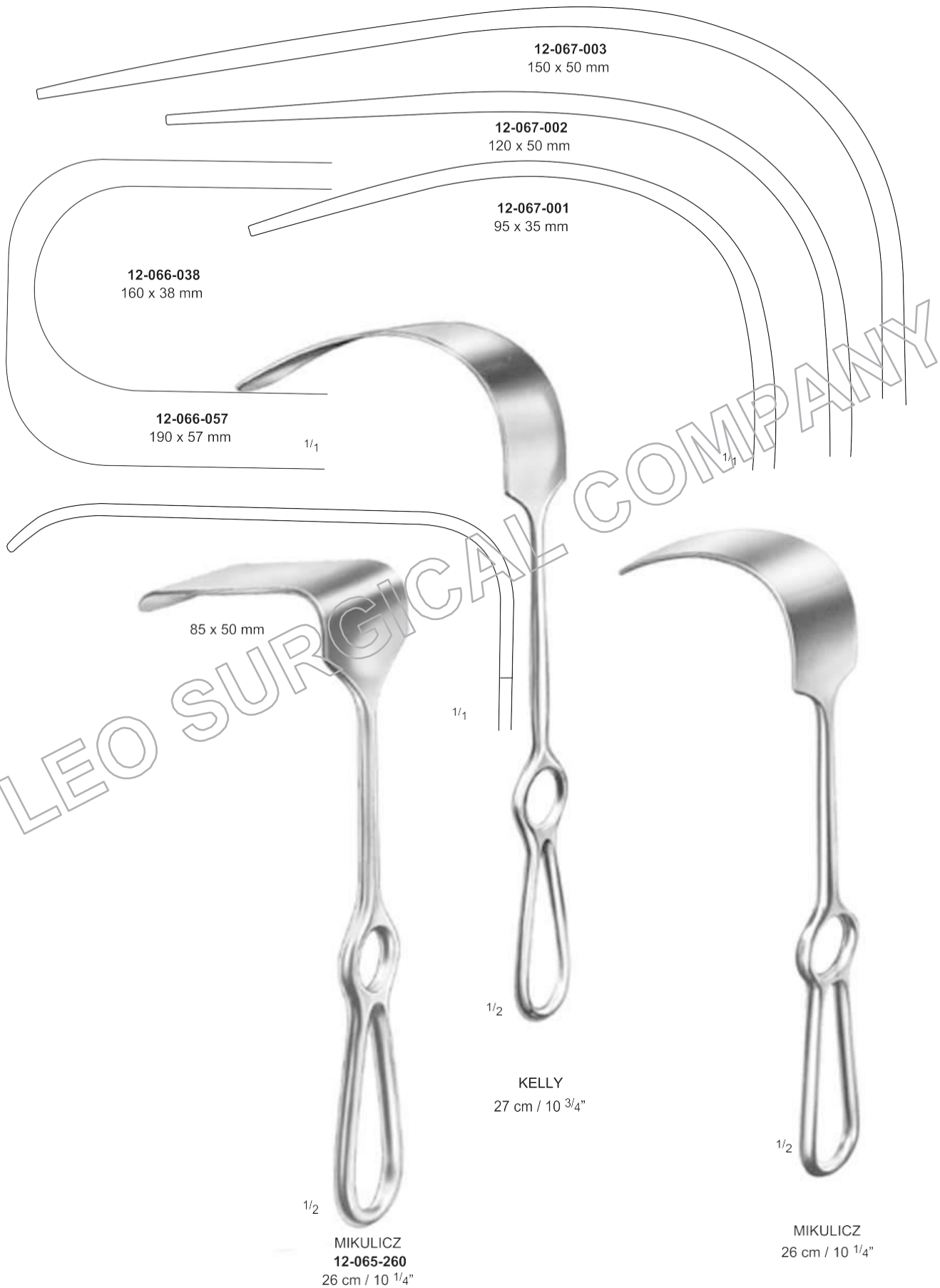

Splanchnic Retractors

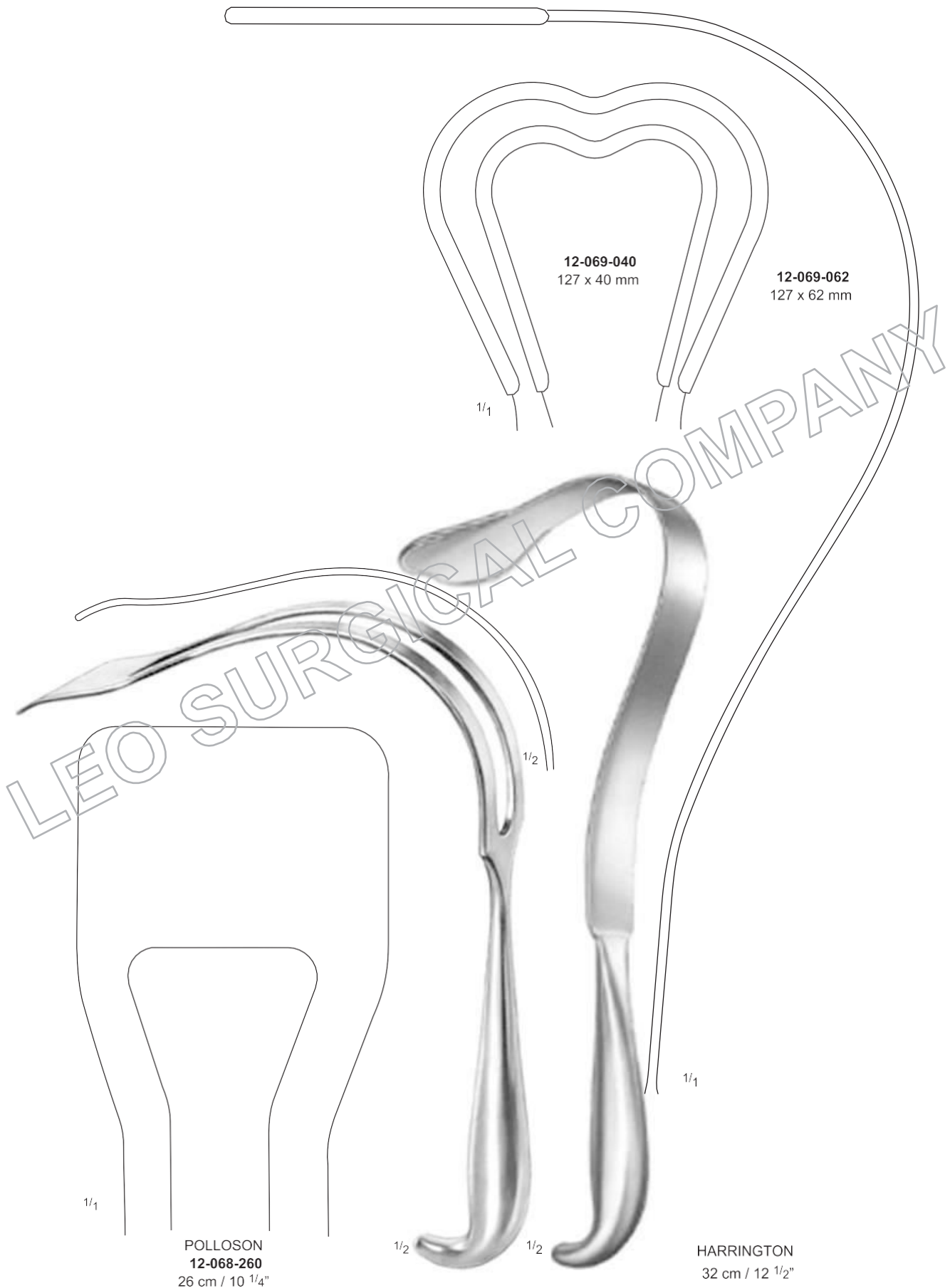

Deaver Retractors



Deaver Retractors



12-076-300
30 cm / 12"

12-077-300
30 cm / 12"

12-078-075 – 75 mm
30 cm / 12"

12-078-100 – 100 mm
30 cm / 12"

Abdominal Retractors, Spatula

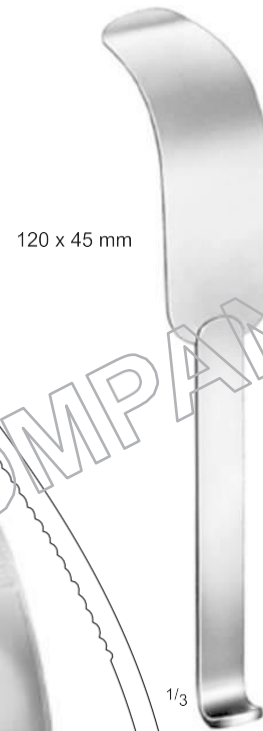
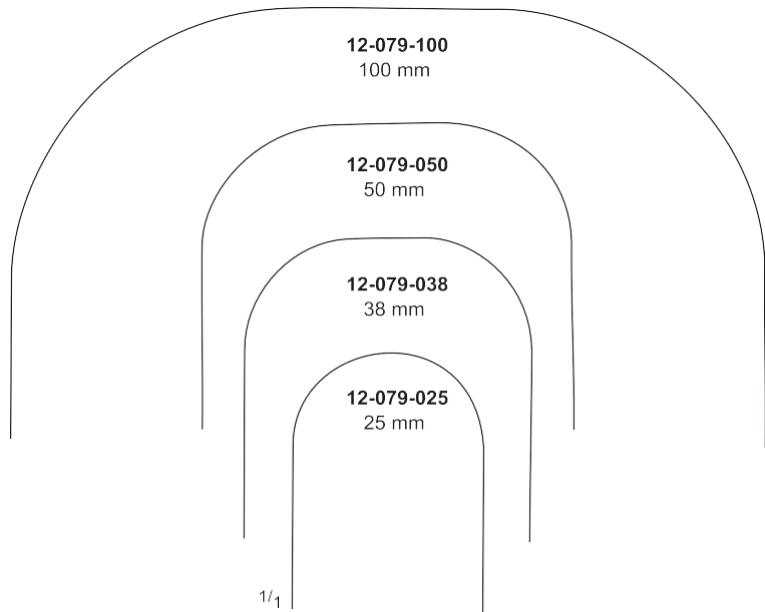

KOERTE
12-083-300
30 cm / 12"



DEAVER
32 cm / 12 1/2"

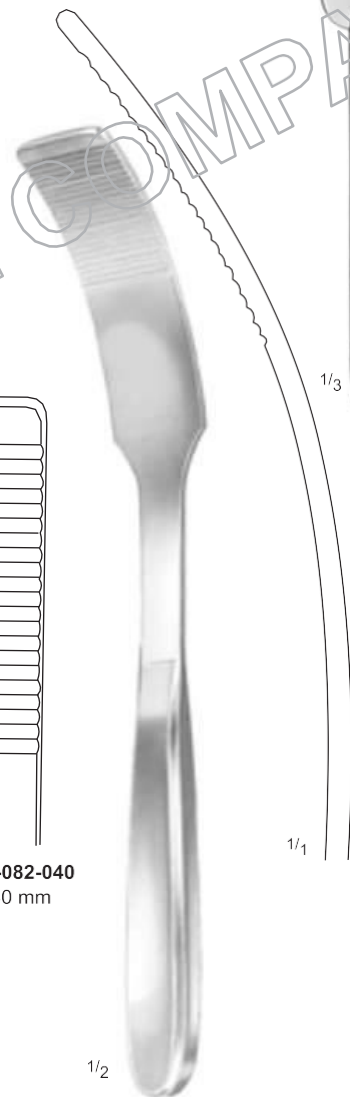
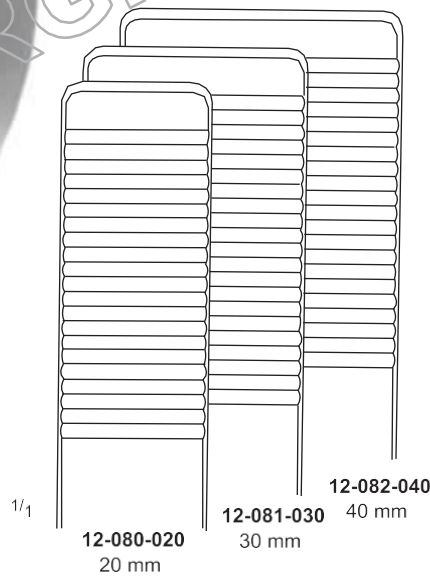

KADER
27 cm / 10 3/4"

Self-retaining Retractors



1/2

JANSEN
12-084-100
10 cm / 4"
3 x 3 teeth

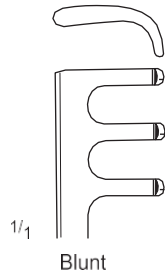

1/4

Blunt



1/2

ALM
4 X 4 teeth



12-085-070
7 cm / 2 3/4"
Sharp

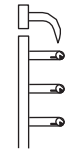

12-085-100
10 cm / 4"
Sharp



1/4

12-086-070
7 cm / 2 3/4"
Blunt

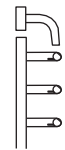

12-086-100
10 cm / 4"
Blunt



1/2

WEITLANER
20 cm / 8"
3 x 4 teeth

80 mm

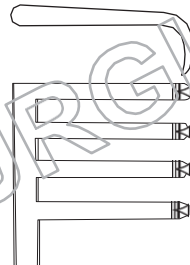

12-087-200
Sharp

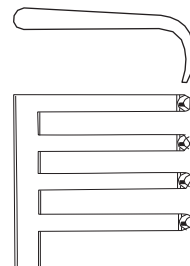

1/4

12-088-200
Blunt

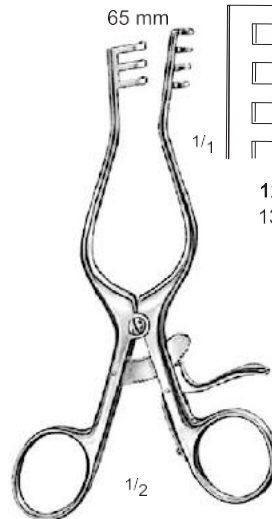

1/2

WEITLANER
3 x 4 teeth

65 mm

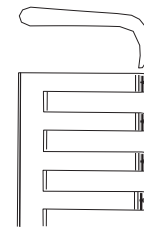

12-089-130
13 cm / 5"
Sharp

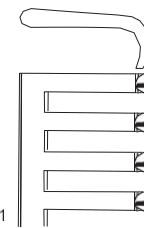

1/4

12-090-130
13 cm / 5"
Blunt

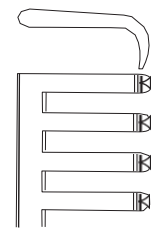

12-089-165
16.5 cm / 6 1/2"
Sharp

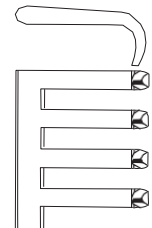

12-090-165
16.5 cm / 6 1/2"
Blunt

Self-retaining Retractors

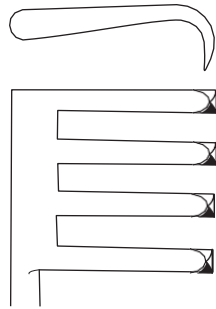

12-091-265
Sharp
3 x 4 teeth

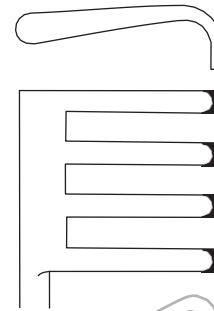

12-092-265
Blunt
3 x 4 teeth



ADSON
26.5 cm / 10 1/2"

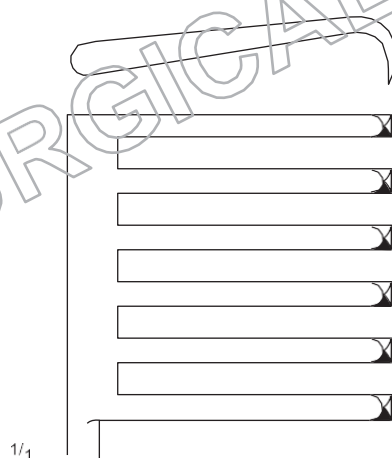

12-093-265
Sharp
6 x 6 teeth

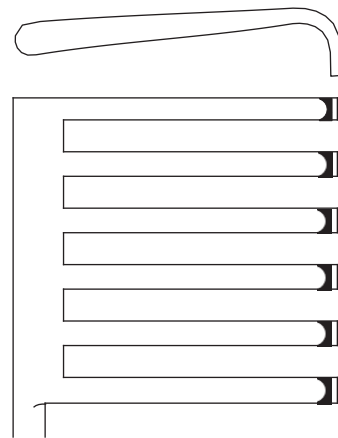

12-094-0265
Blunt
6 x 6 teeth

Self-retaining Retractors

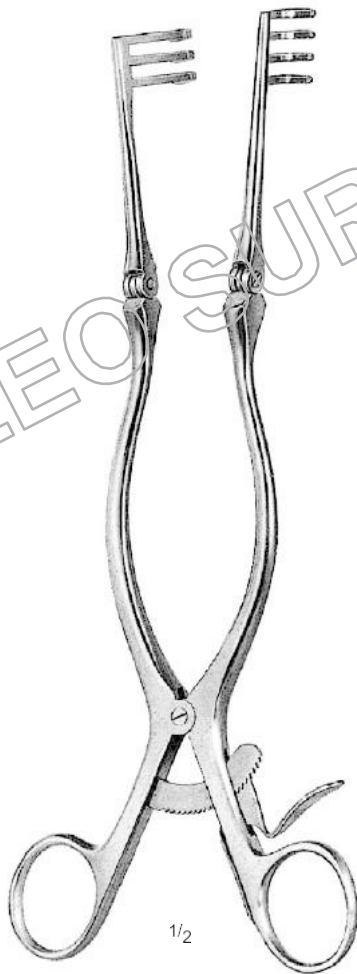

ADSON
3 x 4 teeth

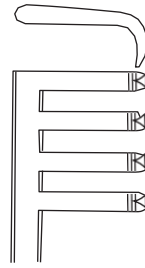

12-095-130
13 cm / 5"

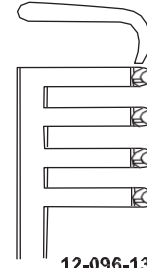

12-096-130
13 cm / 5"

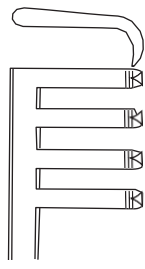

12-095-160
16 cm / 6 1/4"

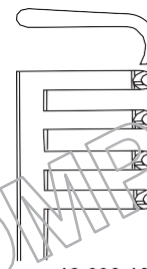

12-096-160
16 cm / 6 1/4"

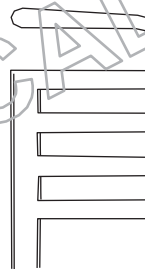

12-095-200
20 cm / 8"

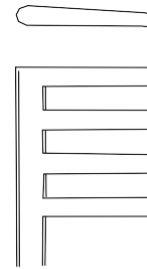

12-096-200
20 cm / 8"

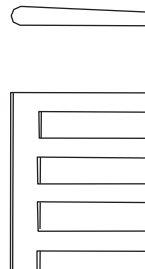

1/1

12-095-260
26 cm / 10 1/4"

Sharp

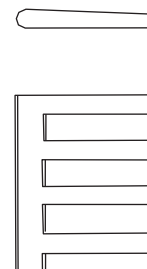

12-096-260
26 cm / 10 1/4"

Blunt

Self-retaining Retractors

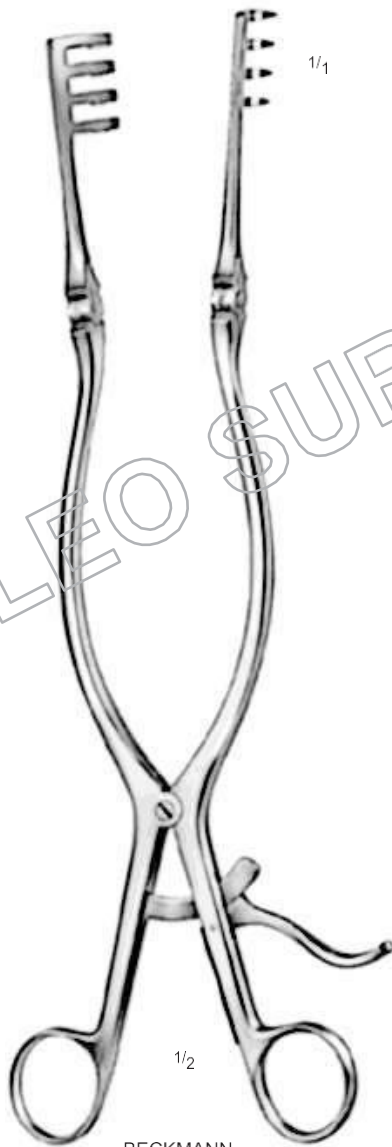
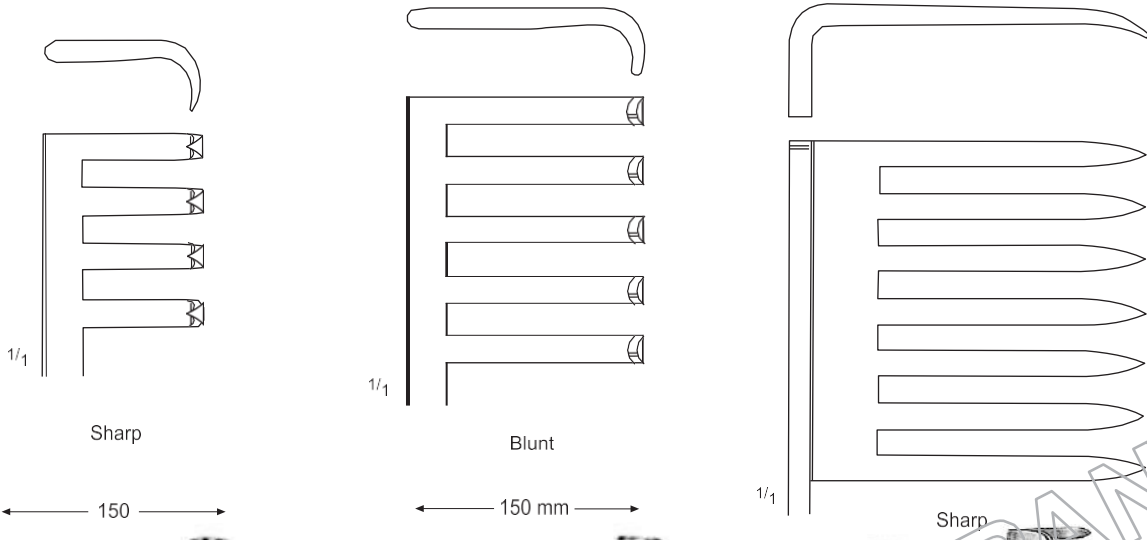

BECKMANN
12-097-310
31 cm / 12 1/4"
4 x 4 teeth



ADSON
12-098-320
32 cm / 12 1/2"
4 x 5 teeth

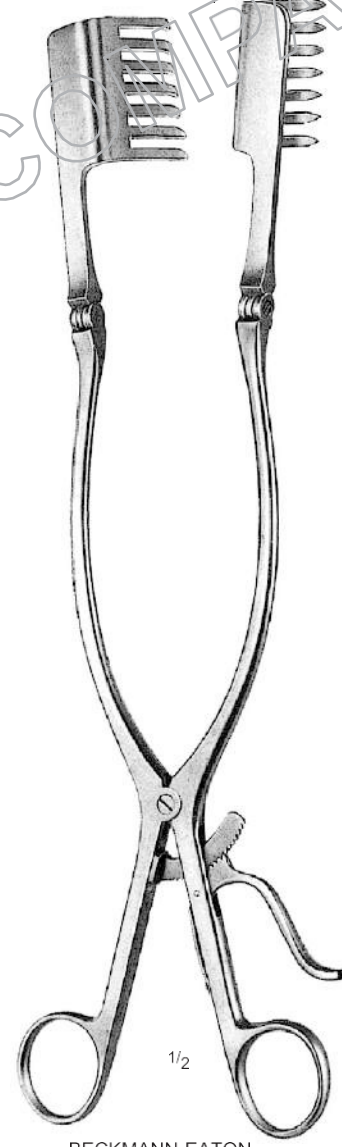

BECKMANN-EATON
12-099-320
32 cm / 12 1/2"
7 x 7 teeth

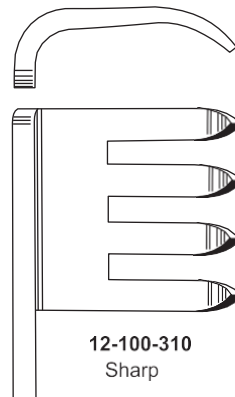

12-100-310
Sharp

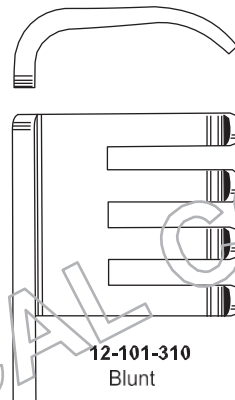

12-101-310
Blunt

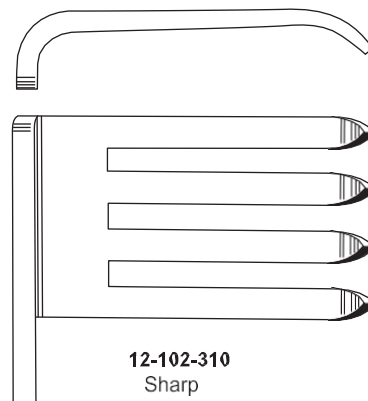

12-102-310
Sharp

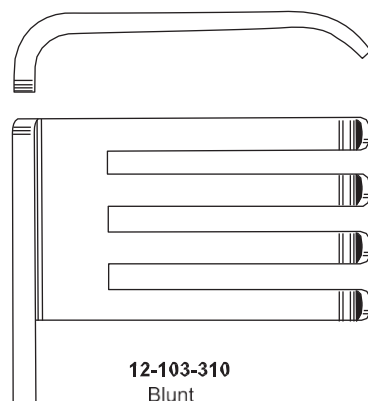

12-103-310
Blunt



BECKMANN-ADSON
31 cm / 12 1/4"
4 x 4 teeth

1/1

LEO SURGICAL COMPANY

Abdominal Retractors

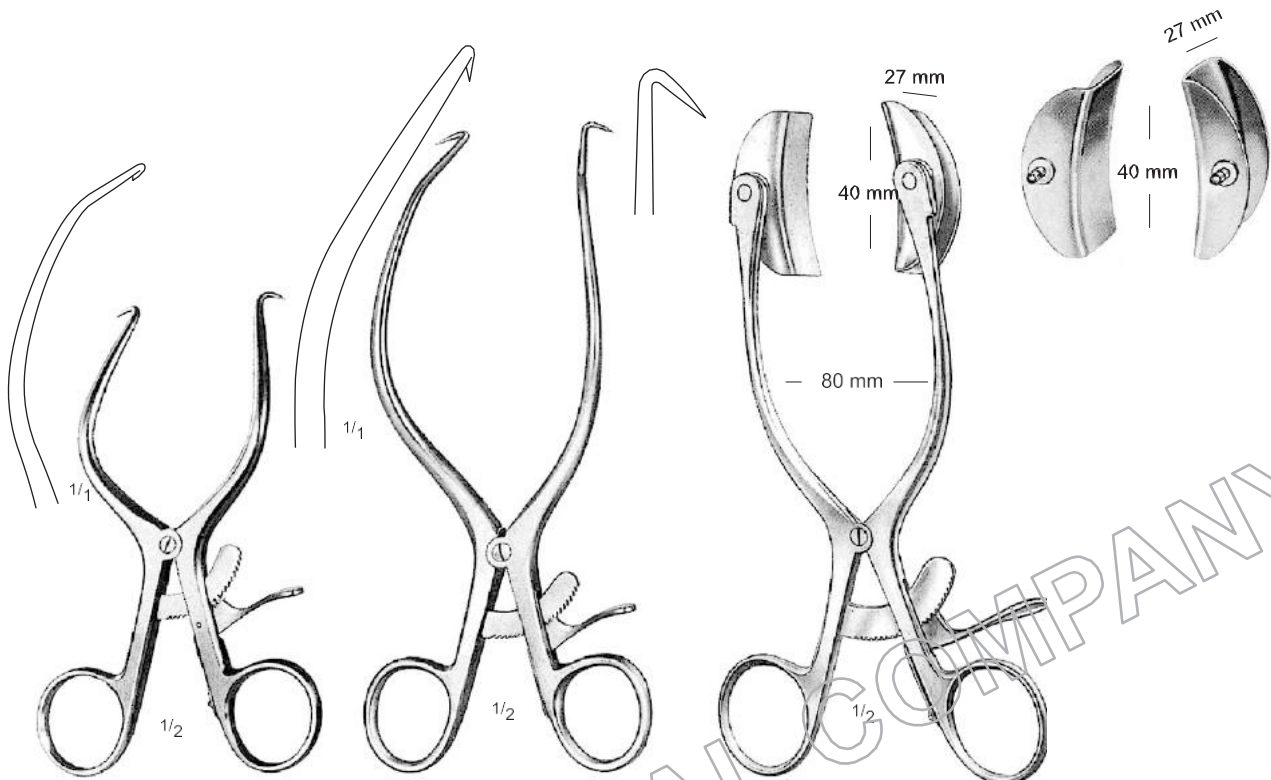

GELPI
12-104-140
14 cm / 5 1/2"

GELPI
12-105-170
17 cm / 6 3/4"

COLLIN BABY
12-106-000
complete with two pair of blades

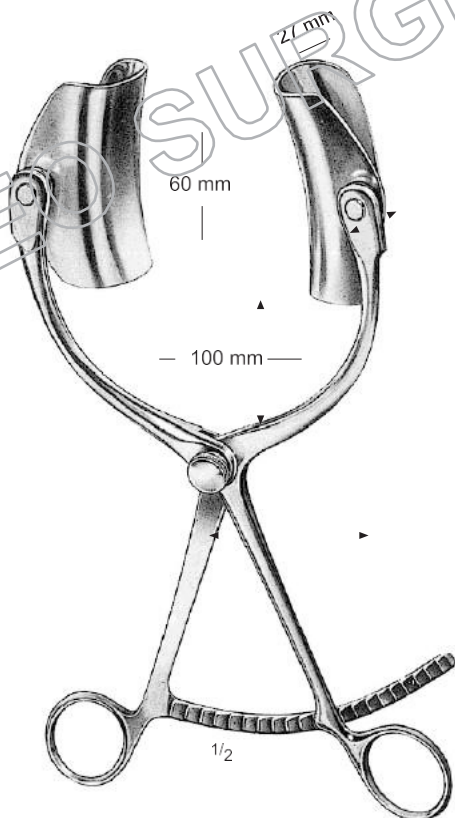

COLLIN
12-107-240
24 cm / 9 1/2"



COLLIN
Lateral Blades Centre Blades
12-108-001 = 38 x 60 mm 38 x 55 mm
12-108-002 = 38 x 80 mm 50 x 75 mm

Abdominal Retractors

Lateral Blades
50 x 58 mm 60 x 80 mm 72 x 85 mm

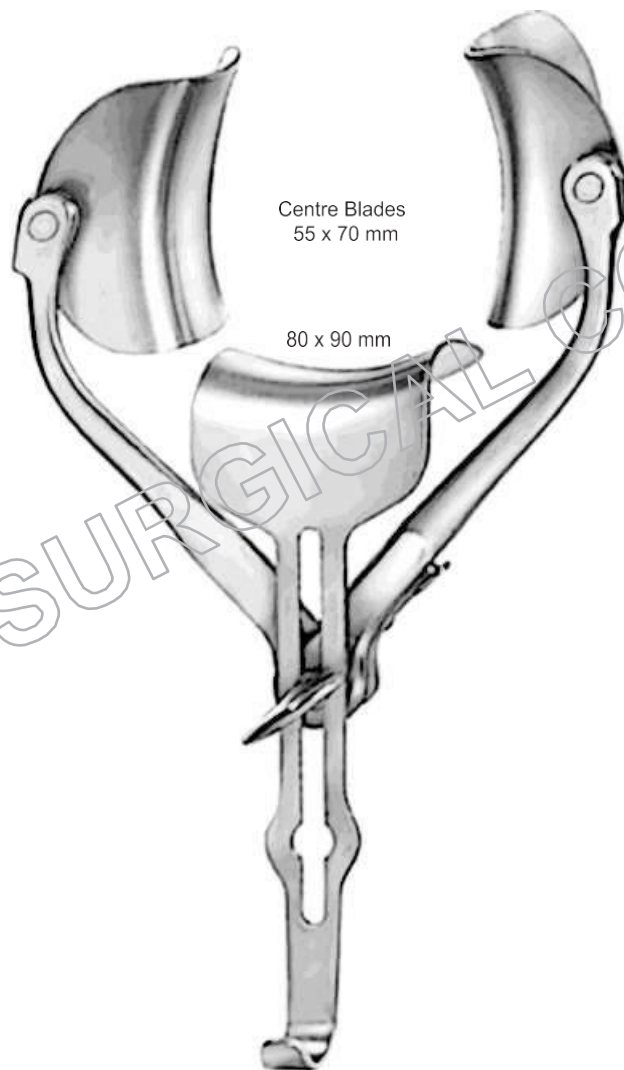

Centre Blades
55 x 70 mm

80 x 90 mm

RICARD
12-109-280 -28 cm / 11"
12-110-300 -30 cm / 12"
complete

Abdominal Retractors

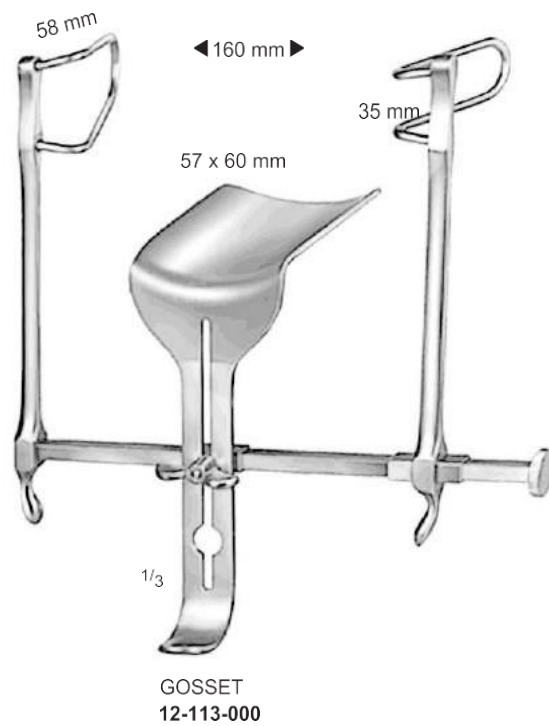
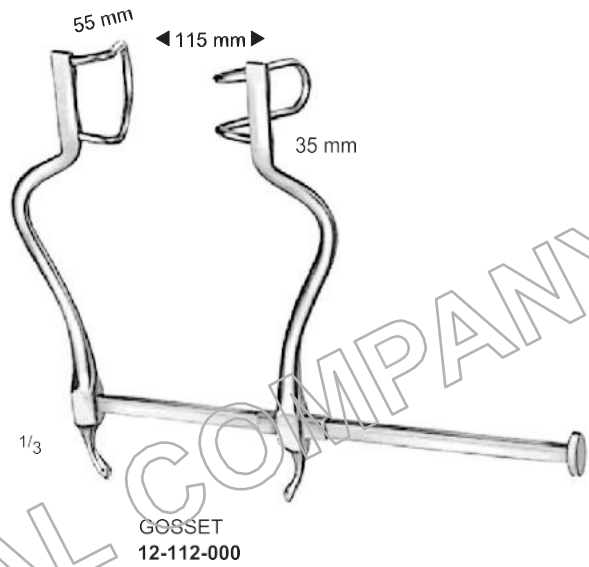
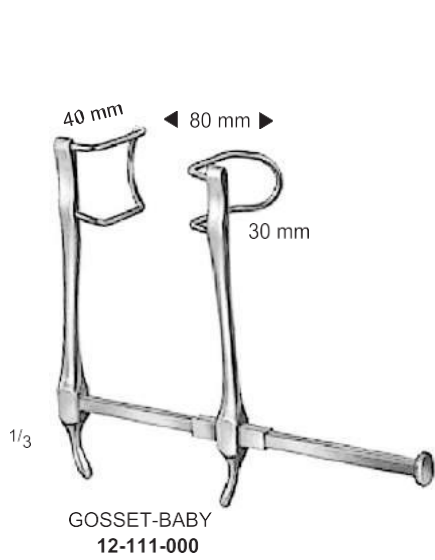

Abdominal Retractors

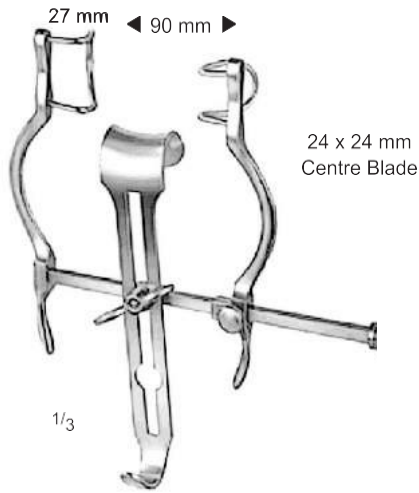

1/3

BALFOUR BABY
12-114-000

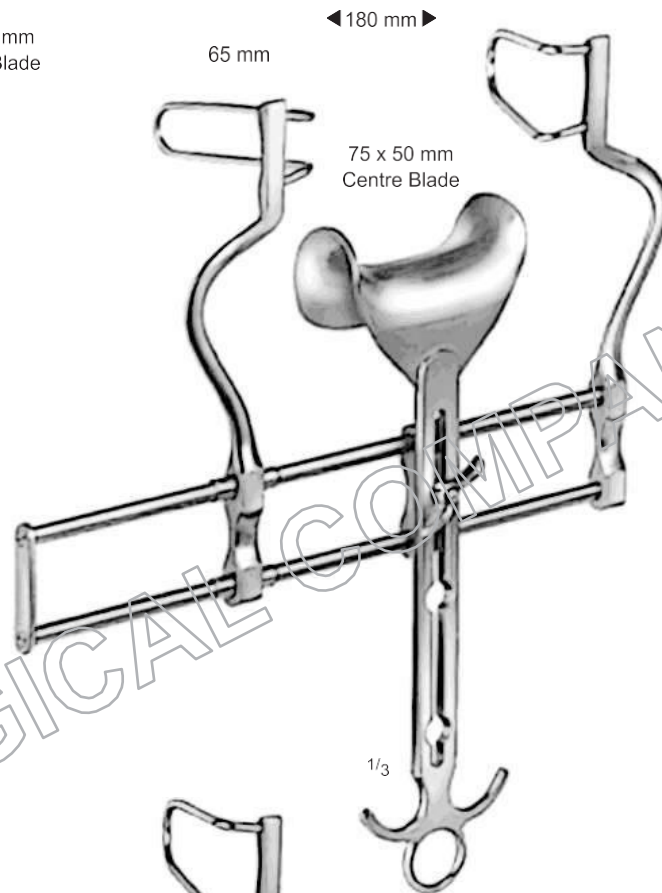

1/3

BALFOUR
12-115-000

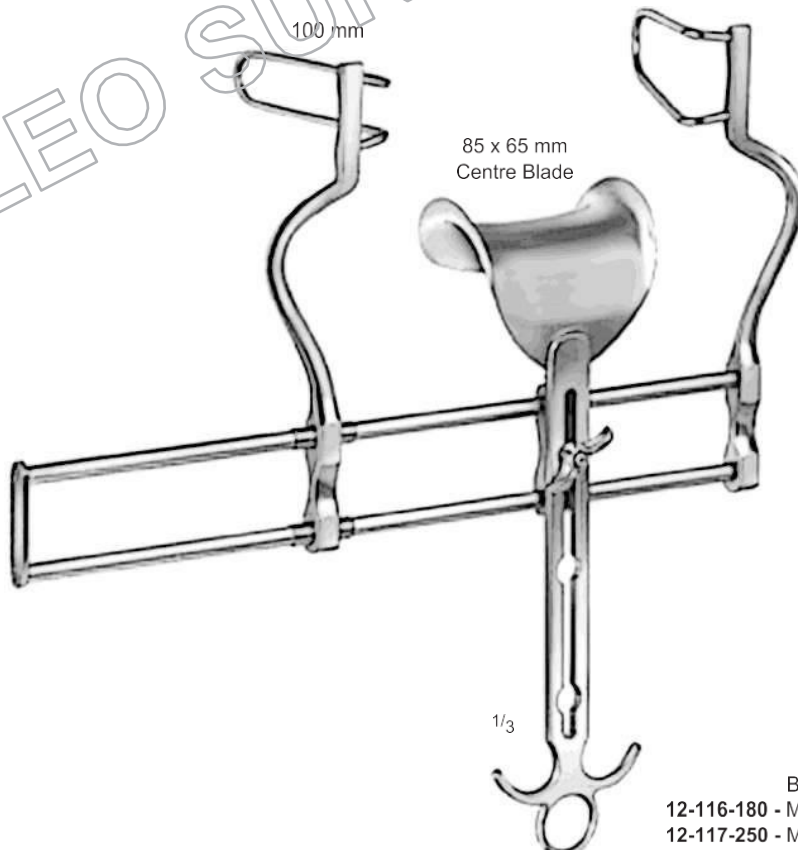

1/3

BALFOUR
12-116-180 - Maximum Spread 180 mm
12-117-250 - Maximum Spread 250 mm

Abdominal Retractors

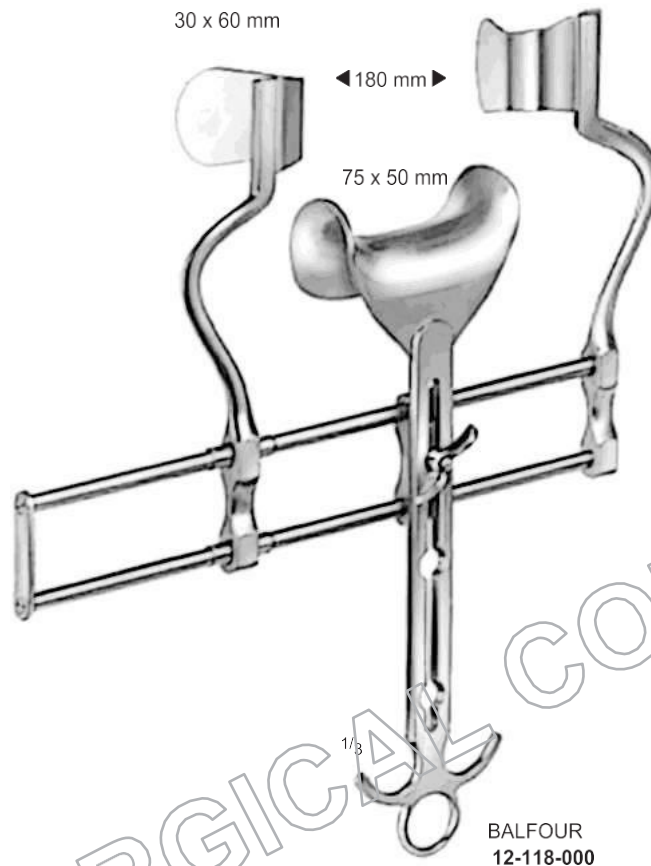

BALFOUR
12-118-000



BALFOUR
12-119-038 63 x 38 mm
12-119-050 75 x 50 mm



12-120-065 85 x 65 mm
12-120-080 80 x 80 mm



DOYEN
12-121-095 – 95 x 60 mm
12-121-105 – 105 x 65 mm
12-121-115 – 115 x 65 mm
12-121-125 – 125 x 65 mm

Abdominal Retractors

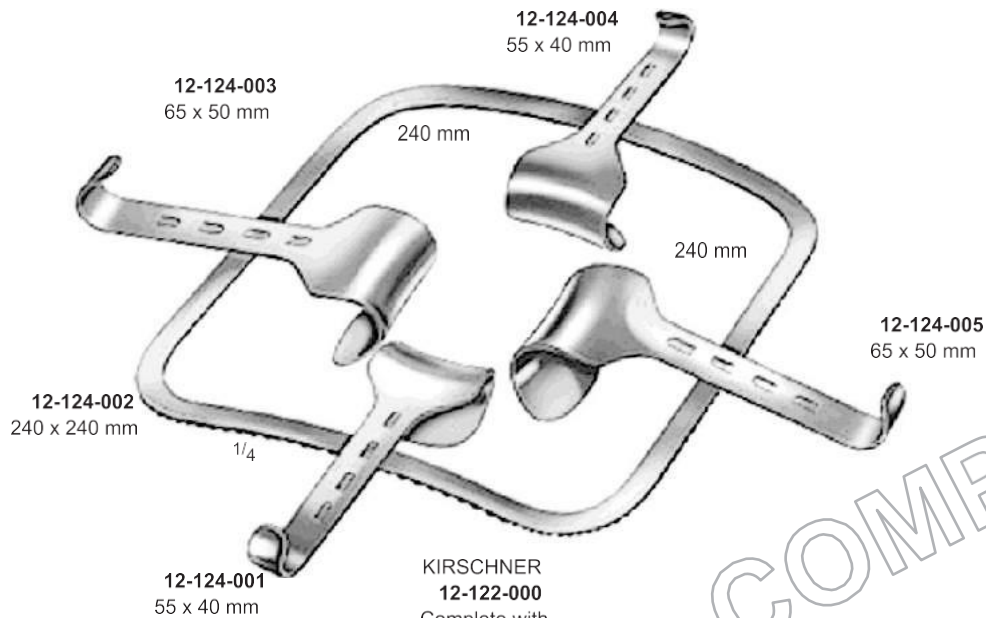

- KIRSCHNER**
12-122-000
Complete with
- 12-123-001 1 Frame rigid - 240 x 240 mm
 - 12-123-002 2 Hook on retractors, 65 x 50 mm
 - 12-123-003 2 Hook on Retractors, 55 x 40 mm

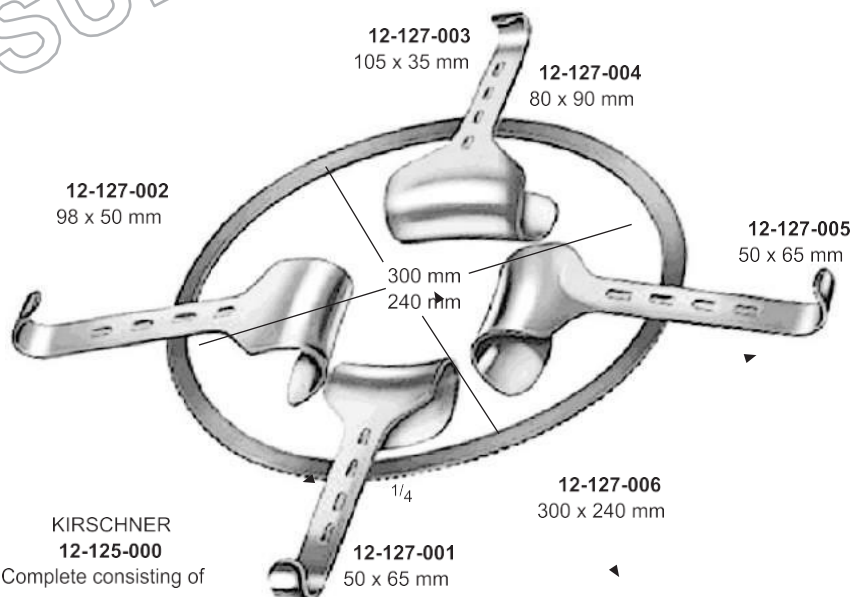

- KIRSCHNER**
12-125-000
Complete consisting of
- 12-126-001 1 Frame, 300 x 240 mm
 - 12-126-002 3 hook-on retractors, 50 x 65 mm
 - 12-126-003 1 retractor, 80 x 90 mm
 - 12-126-004 1 retractor, 98 x 50 mm
 - 12-126-005 1 retractor, 105 x 35 mm