

Cardiovascular

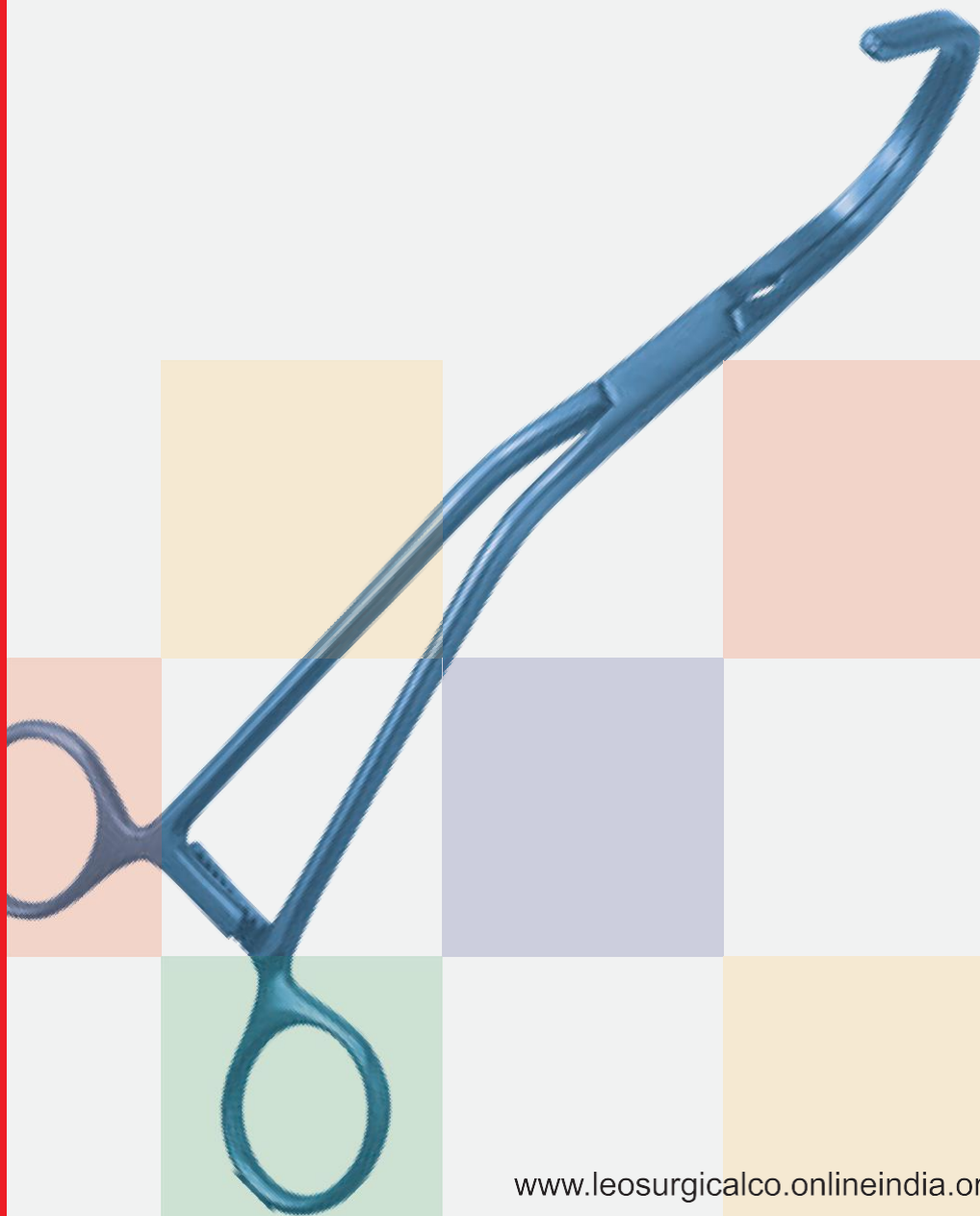

Atraumatic Bulldog Clamps

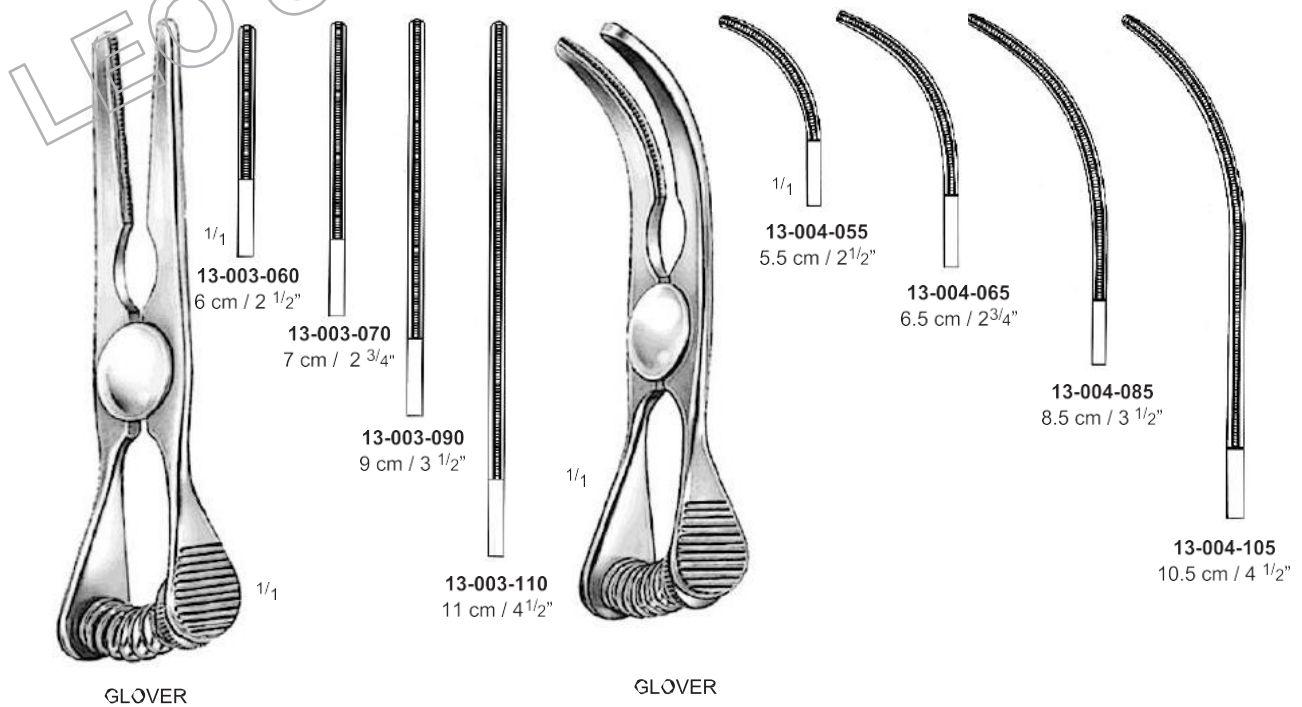
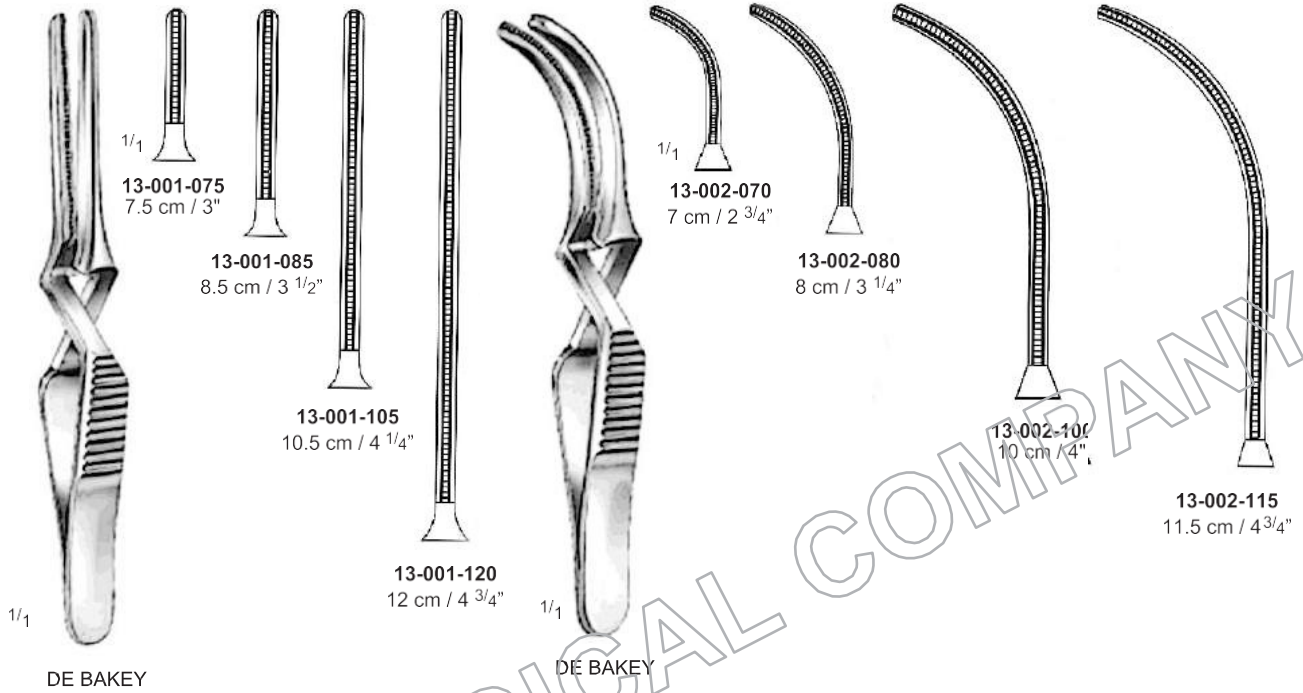

Atraumatic Cardiovascular Forceps

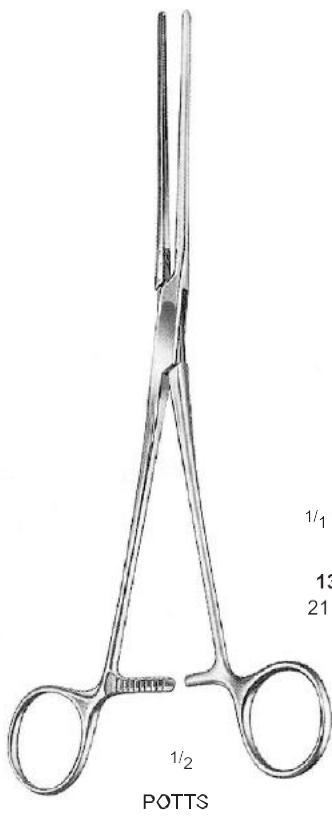

13-005-210
 21 cm / 8 1/4"



13-005-220
 22 cm / 8 3/4"

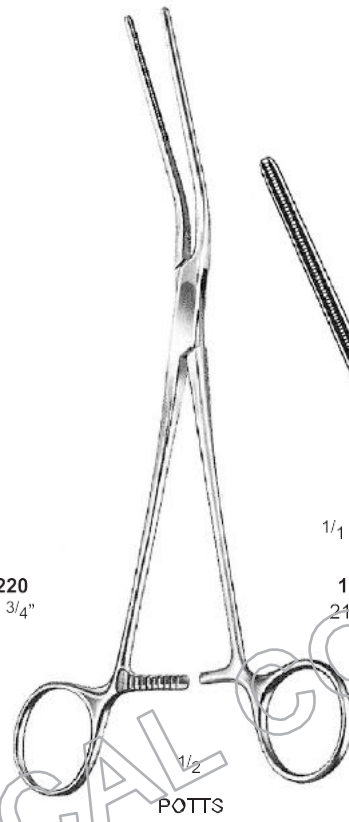

13-006-210
 21 cm / 8 1/4"



13-006-220
 22 cm / 8 3/4"

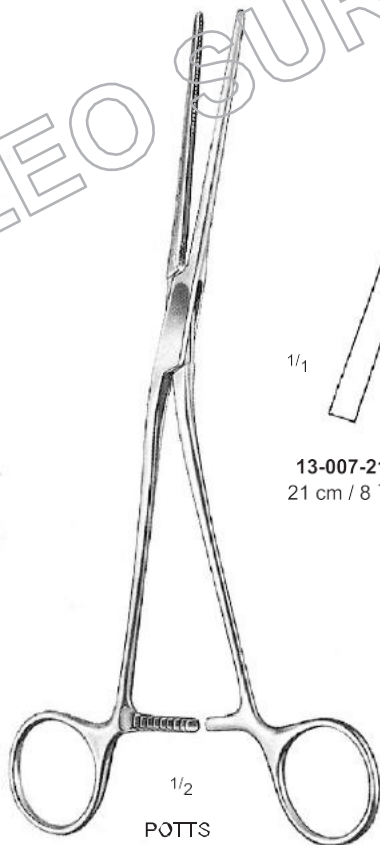
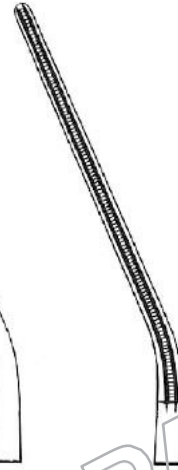

13-007-210
 21 cm / 8 1/4"



13-007-220
 22 cm / 8 3/4"



Atraumatic Cardiovascular Forceps

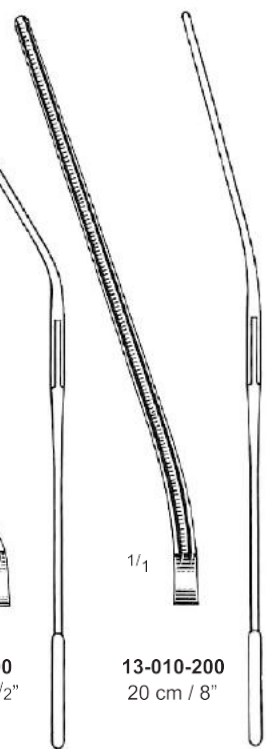
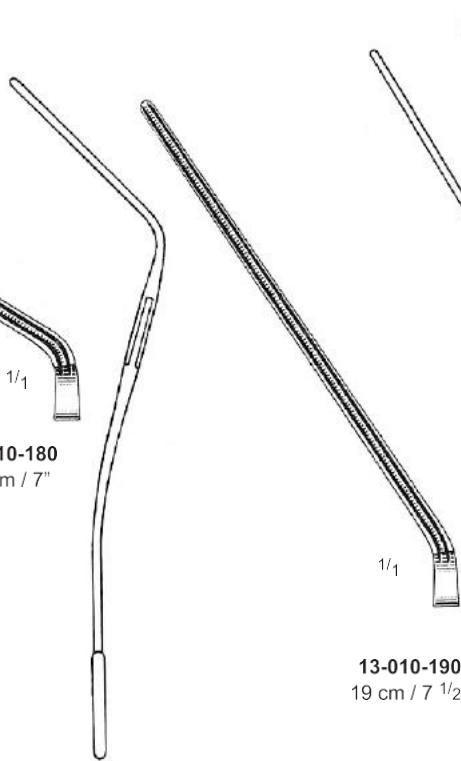
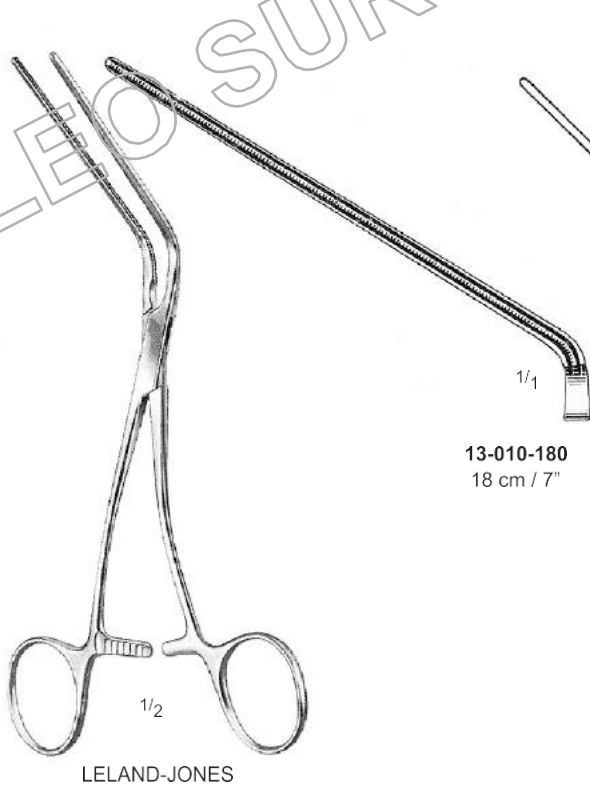
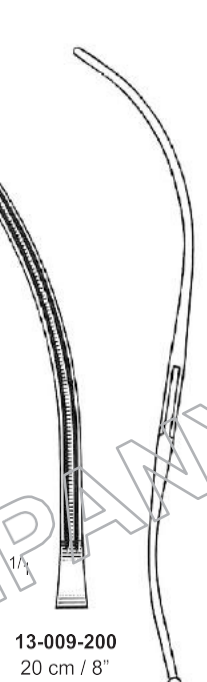
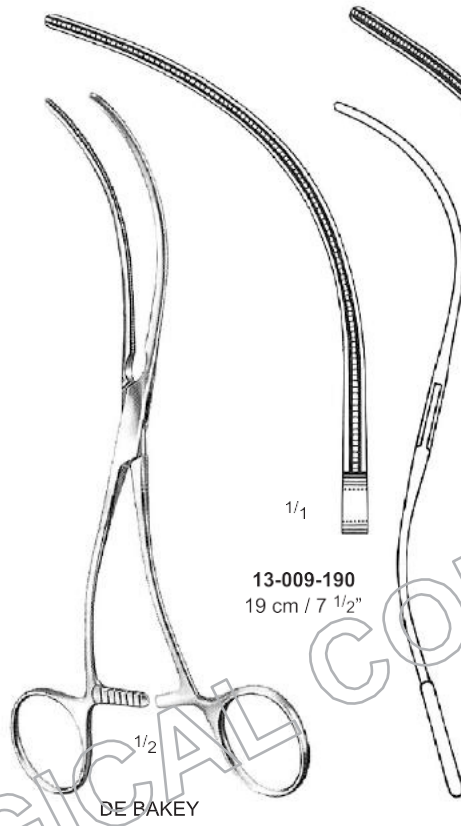
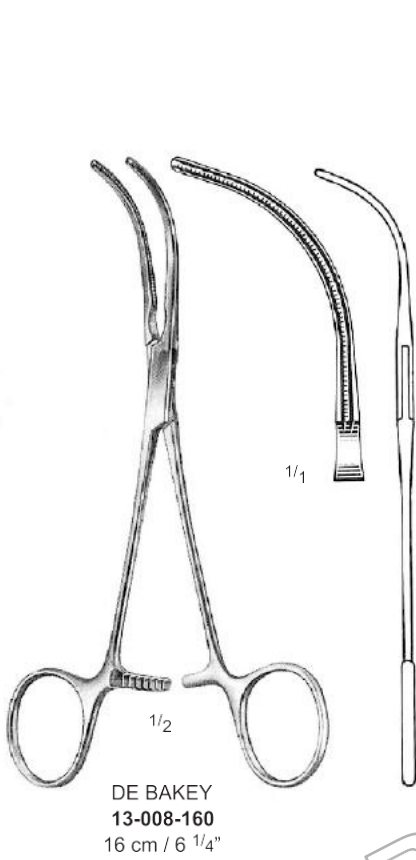

LELAND-JONES

Atraumatic Cardiovascular Forceps

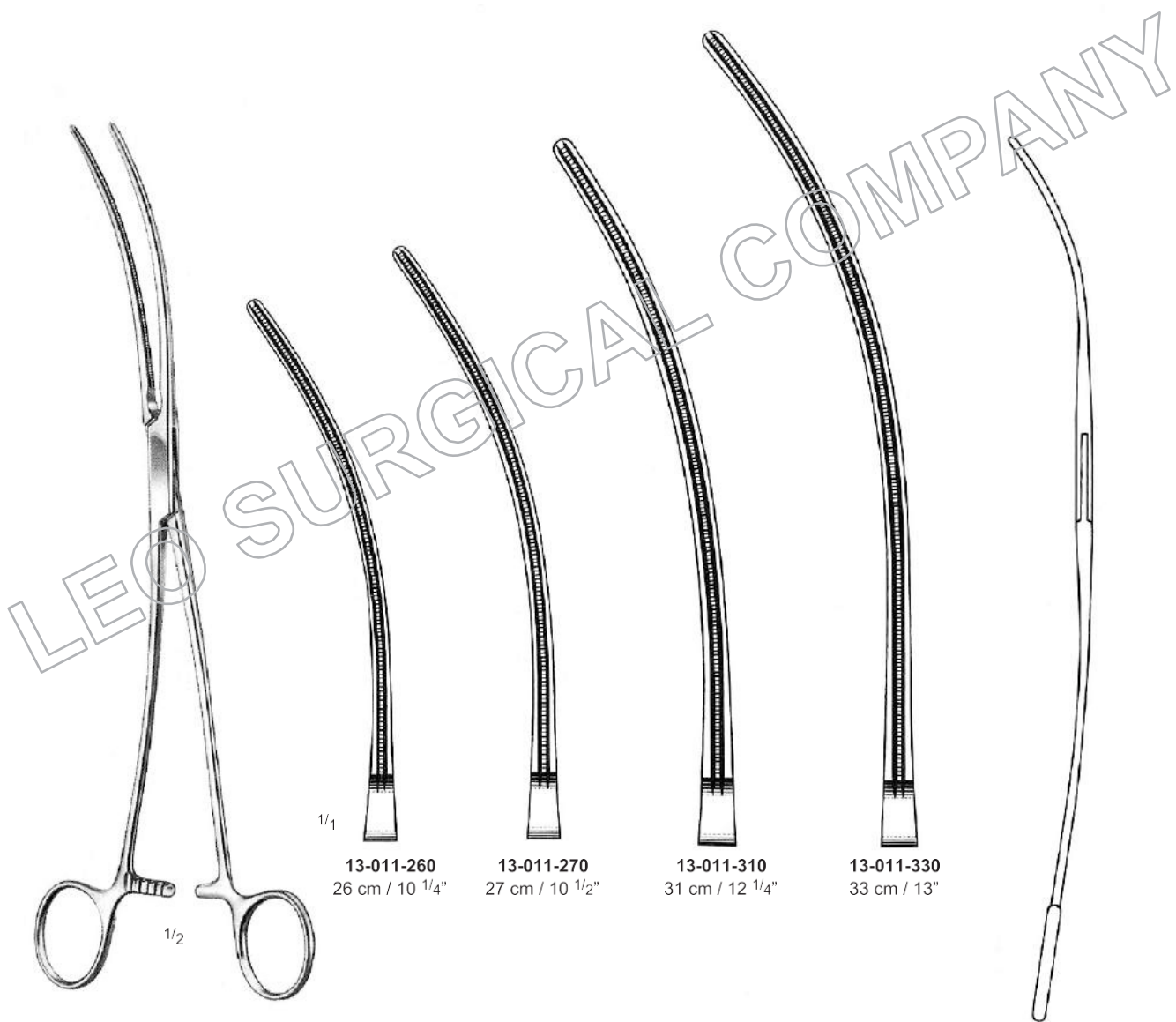

Atraumatic Cardiovascular Forceps



DE BAKEY
 13-012-260
 26 cm / 10 1/4"



SATINSKY

13-012-275
 27.5 cm / 10 3/4"

13-012-265
 26.5 cm / 10 1/2"

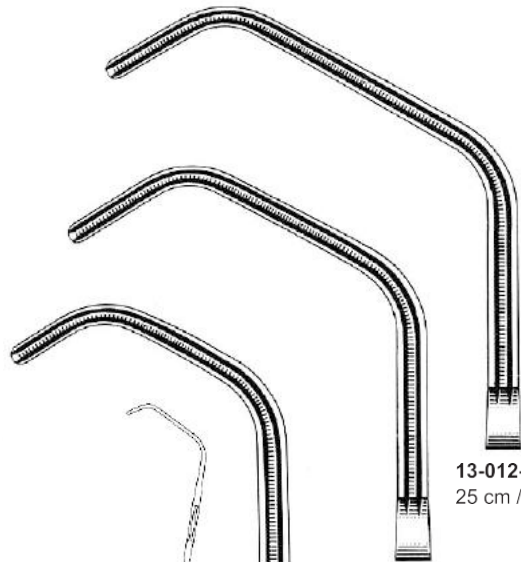

13-012-250
 25 cm / 10"

13-012-240
 24 cm / 9 1/2"

13-012-205
 20.5 cm / 8 1/4"

LEO SURGICAL COMPANY

Atraumatic Cardiovascular Forceps

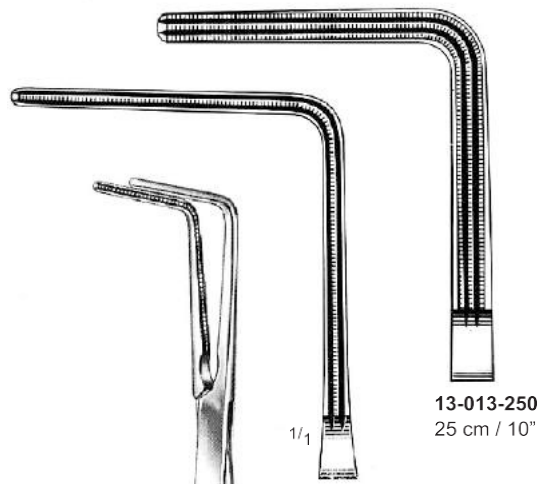

13-013-250
 25 cm / 10"



13-013-230
 23 cm / 9"



LAMBERT-KAY
 13-014-210
 21 cm / 8 1/4"



LEES

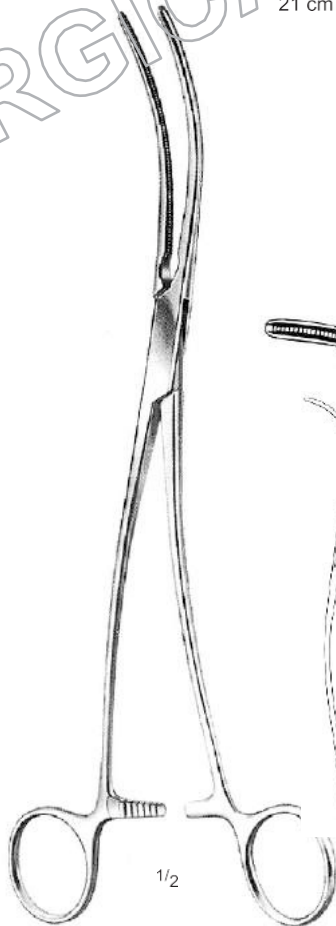

DE BAKEY

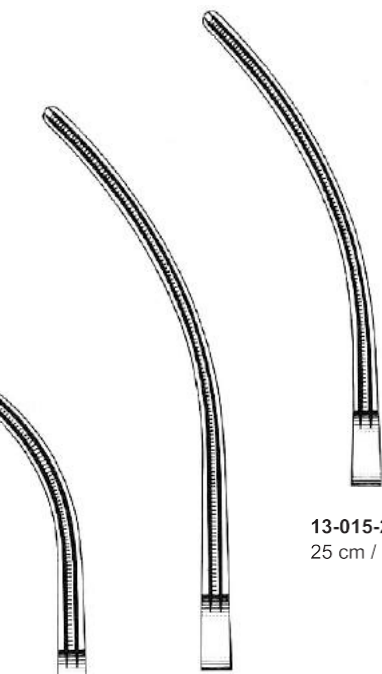

13-015-250
 25 cm / 10"

13-015-240
 24 cm / 9 1/2"

13-015-230
 23 cm / 9"

LEO SURGICAL COMPANY

Atraumatic Cardiovascular Forceps

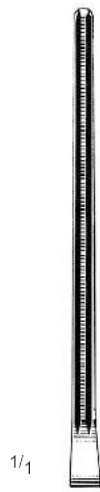
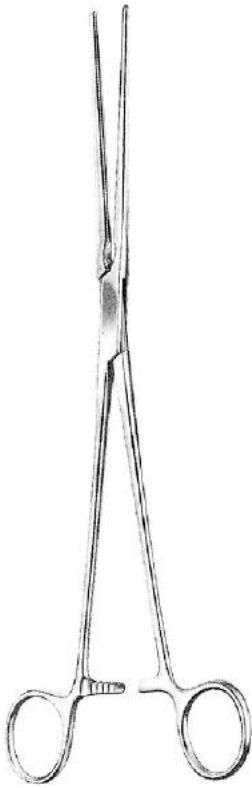

13-016-215
 21.5 cm / 8 1/2"



13-016-230
 23 cm / 9"



13-016-270
 27 cm / 10 1/2"



13-016-315
 31.5 cm / 12 1/2"

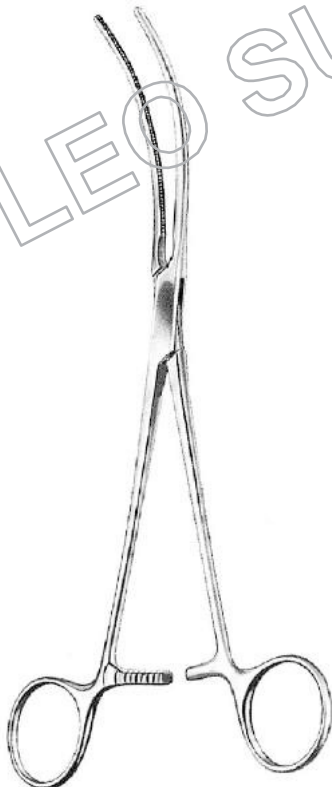

13-017-215
 21.5 cm / 8 1/2"



13-017-230
 23 cm / 9"



13-017-270
 27 cm / 10 1/2"

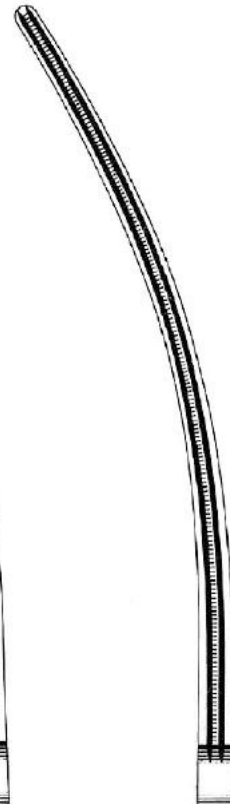

13-017-315
 31.5 cm / 12 1/2"

Atraumatic Cardiovascular Forceps

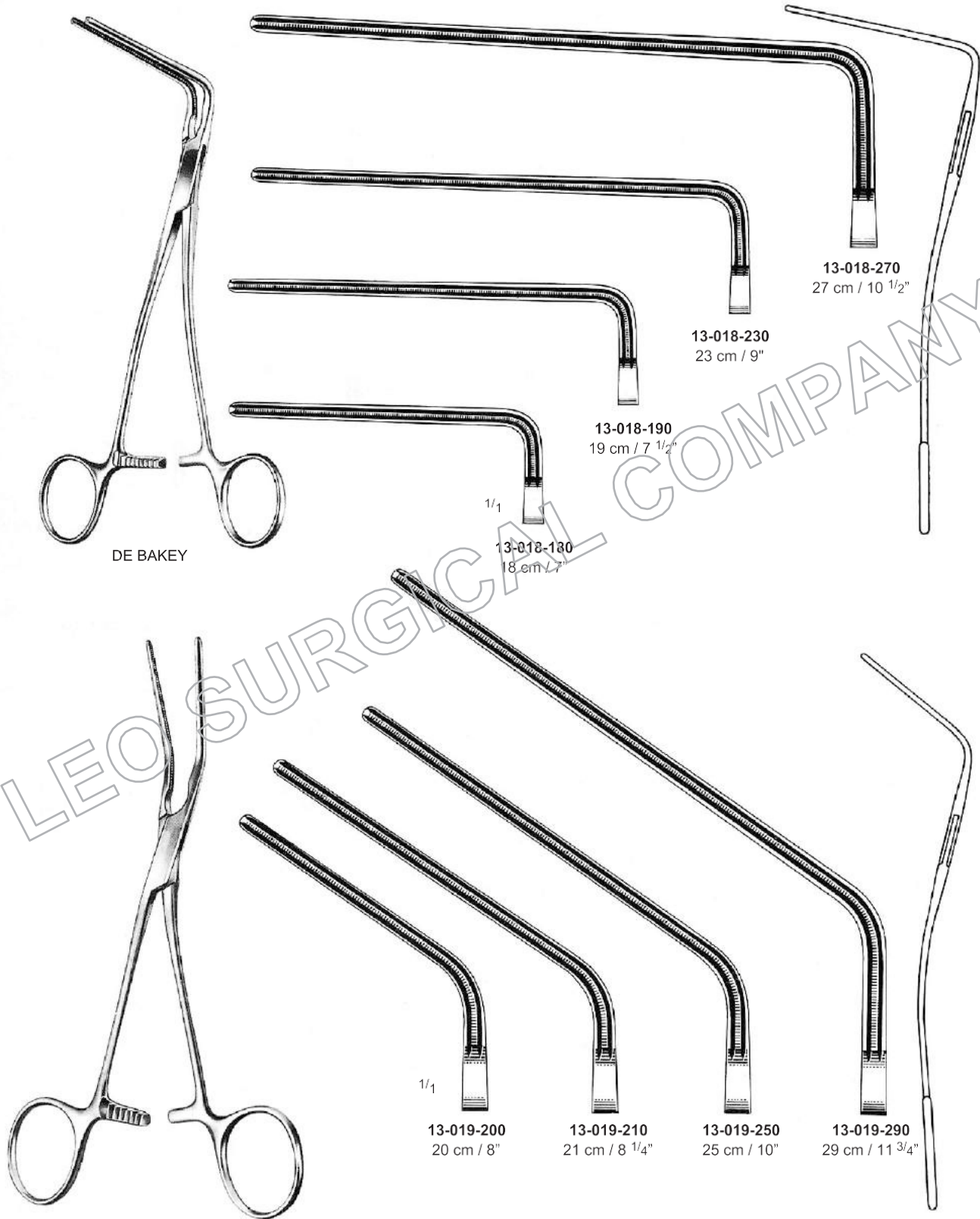

23. 42.20 – 23. 42.29 – Multi Purpose Clamps

Atraumatic Cardiovascular Forceps

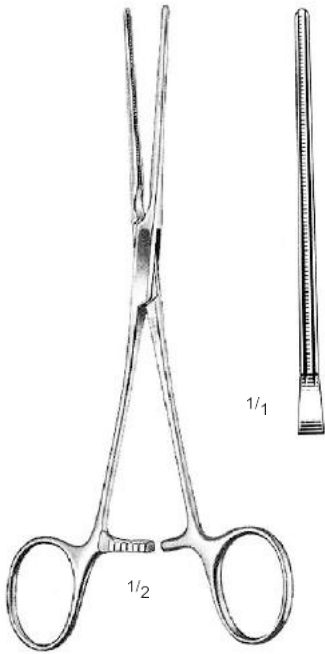

DE BAKEY
 13-020-170
 17 cm / 6 3/4"

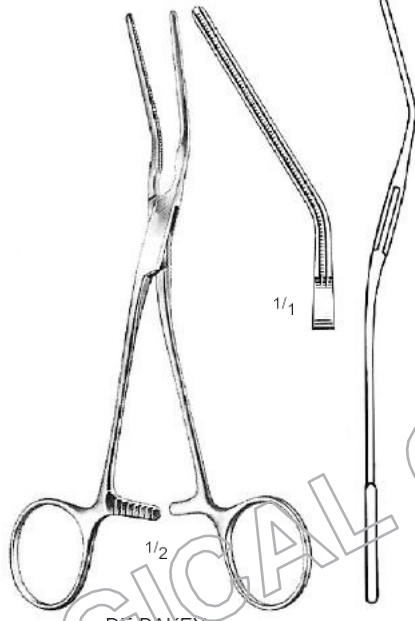

DE BAKEY
 13-021-160
 16 cm / 6 1/4"

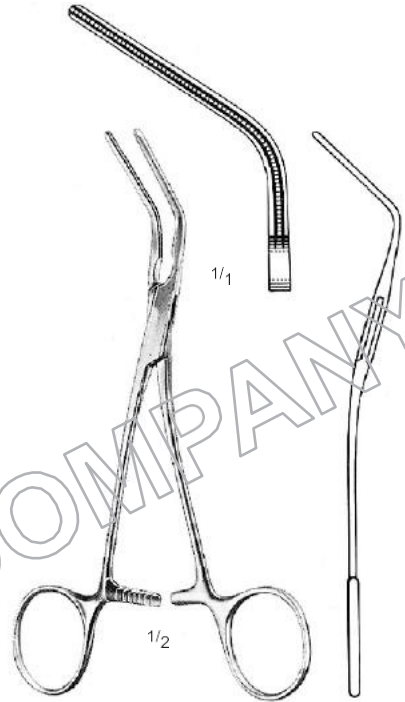

DE BAKEY
 13-022-150
 15 cm / 6"

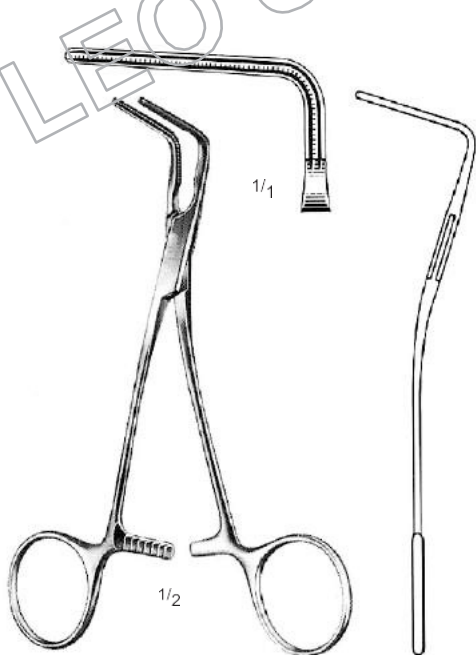

DE BAKEY
 13-023-150
 15 cm / 6"

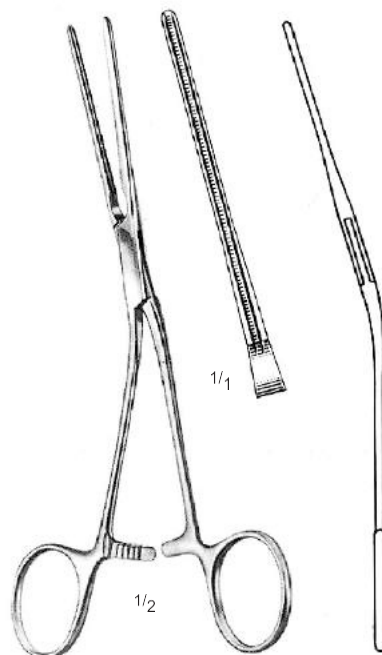

DE BAKEY
 13-024-170
 17 cm / 6 3/4"

Atraumatic Cardiovascular Forceps

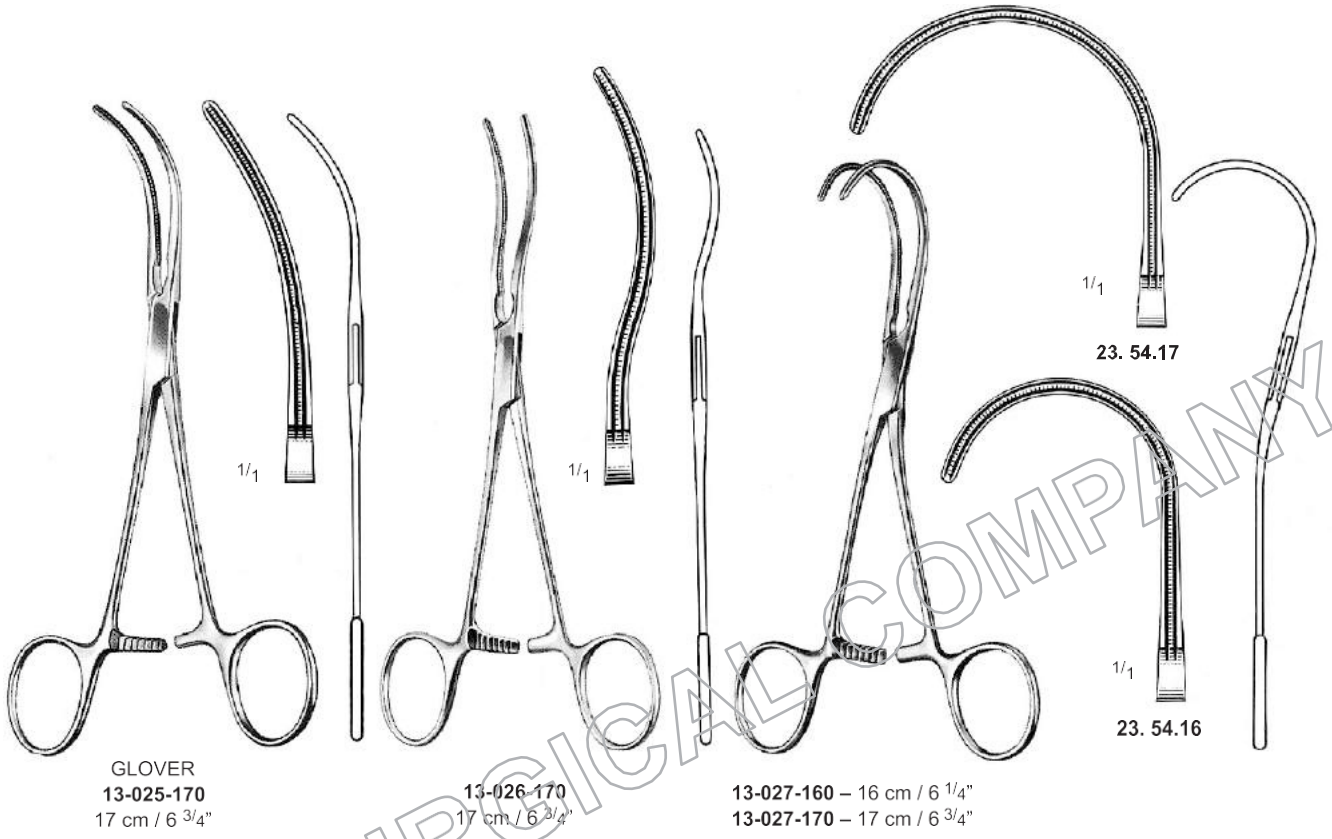

GLOVER
 13-025-170
 17 cm / 6 3/4"

13-026-170
 17 cm / 6 3/4"

13-027-160 – 16 cm / 6 1/4"
 13-027-170 – 17 cm / 6 3/4"

23. 54.17

23. 54.16

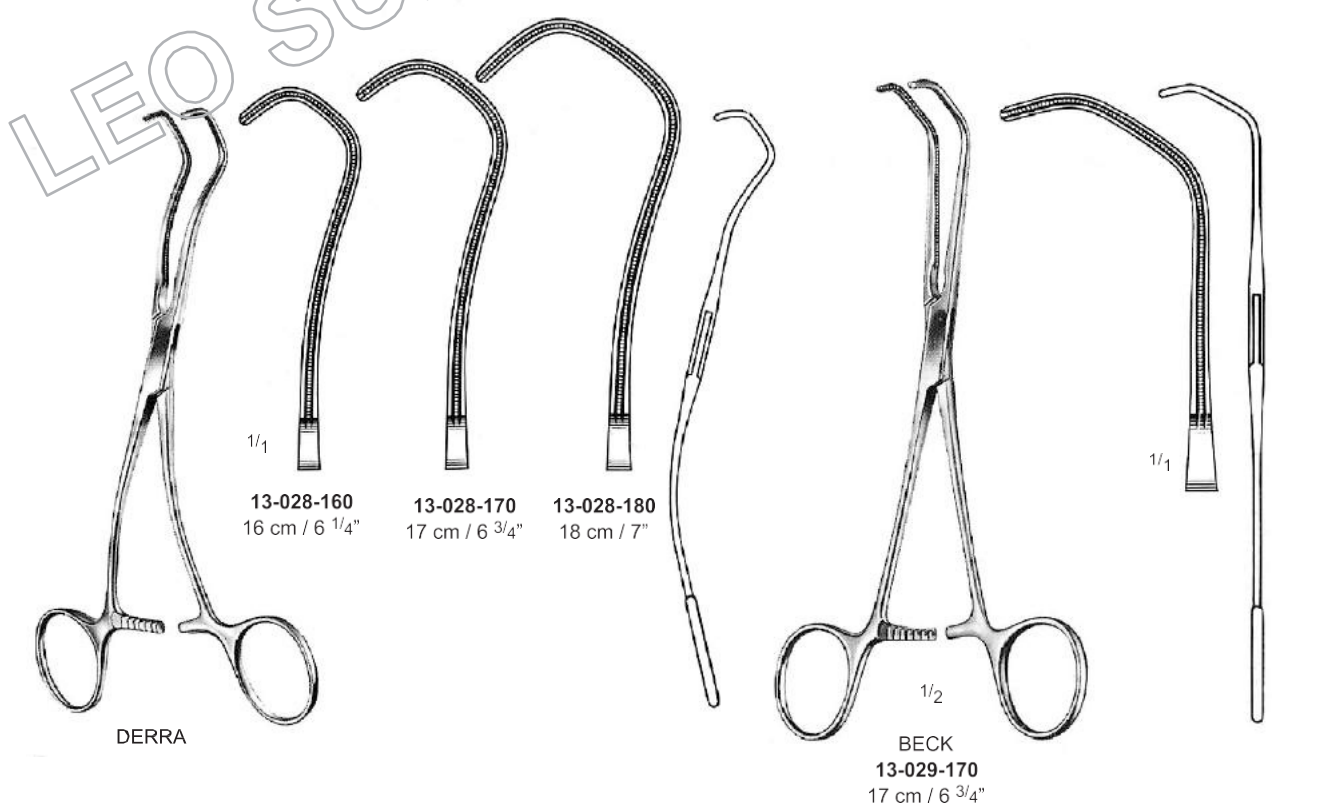

DERRA

13-028-160
 16 cm / 6 1/4"

13-028-170
 17 cm / 6 3/4"

13-028-180
 18 cm / 7"

BECK
 13-029-170
 17 cm / 6 3/4"

Atraumatic Bulldog Clamps

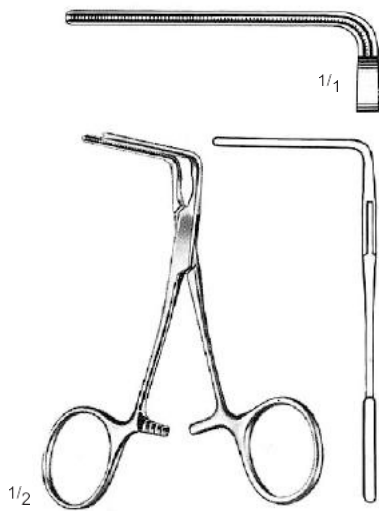

DE BAKEY
 13-030-100
 10 cm / 4"

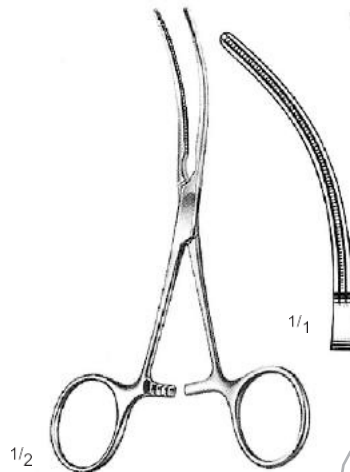

DE BAKEY
 13-031-110
 11 cm / 4 1/4"

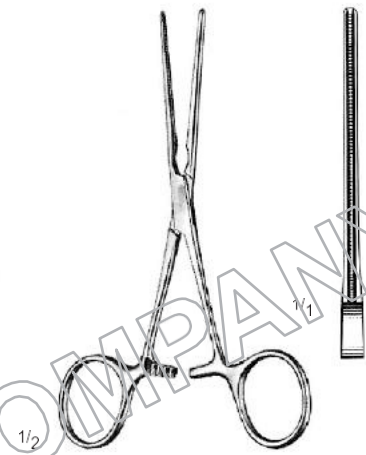

DE BAKEY
 13-032-120
 12 cm / 4 3/4"

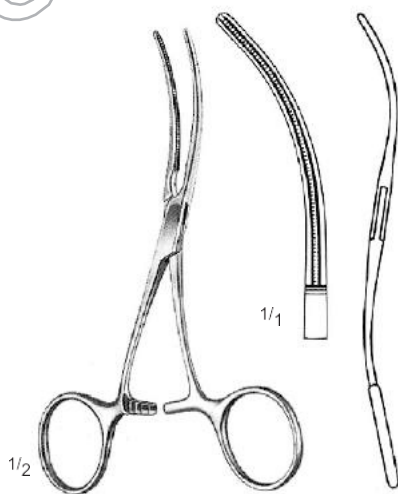

DE BAKEY
 13-033-120
 12 cm / 4 3/4"

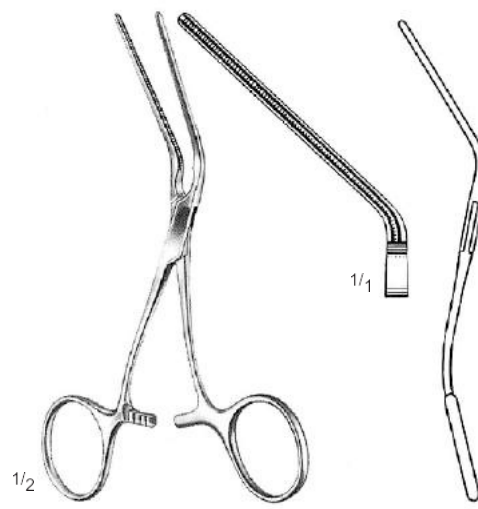

DE BAKEY
 13-034-130
 13 cm / 5"

LEO SURGICAL COMPANY

Vascular Di

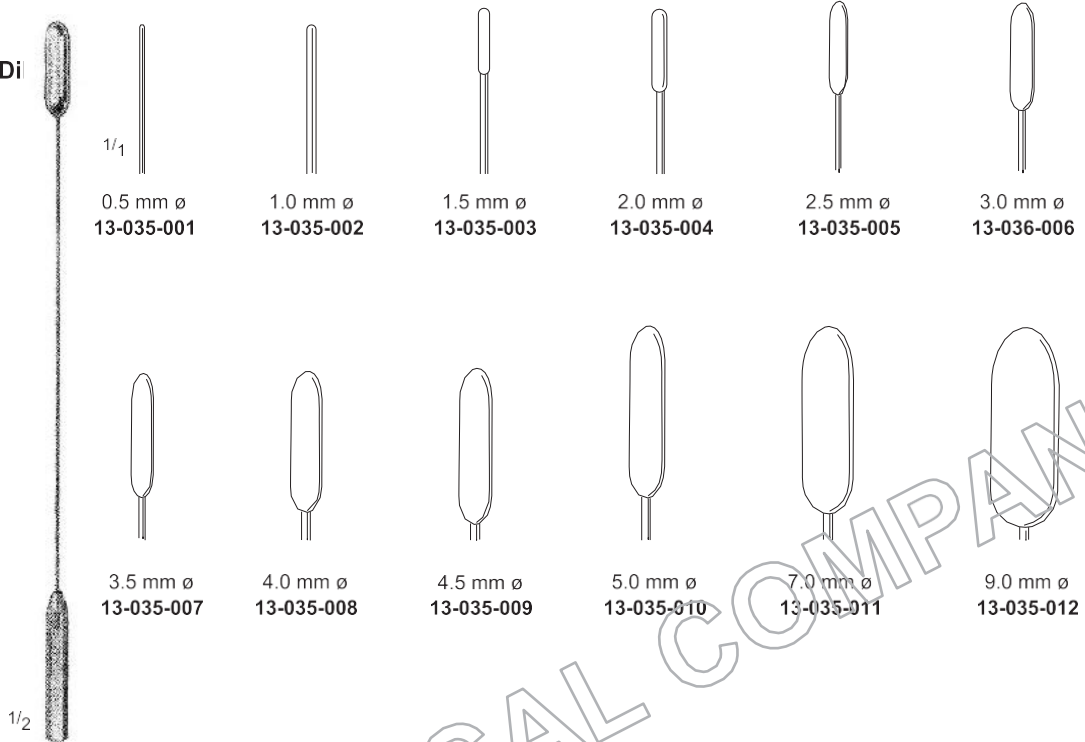

0.5 mm ø 13-035-001 1.0 mm ø 13-035-002 1.5 mm ø 13-035-003 2.0 mm ø 13-035-004 2.5 mm ø 13-035-005 3.0 mm ø 13-036-006

3.5 mm ø 13-035-007 4.0 mm ø 13-035-008 4.5 mm ø 13-035-009 5.0 mm ø 13-035-010 7.0 mm ø 13-035-011 9.0 mm ø 13-035-012

DE BAKEY
 19 cm / 7 1/2"
 35 cm / 14"

LEO SURGICAL COMPANY



GARRETT
 14 cm / 5 1/2"
 13-036-000
 Set of 9 pieces from

13-037-001 ø 1,0 mm
 13-037-002 ø 1,5 mm
 13-037-003 ø 2,0 mm
 13-037-004 ø 2,5 mm
 13-037-005 ø 3,0 mm
 13-037-006 ø 3,5 mm
 13-037-007 ø 4,0 mm
 13-037-008 ø 4,5 mm
 13-037-009 ø 5,0 mm



GARRETT
 21 cm / 8 1/4"
 13-038-000
 Set of 9 pieces from

13-039-001 ø 1,0 mm
 13-039-002 ø 1,5 mm
 13-039-003 ø 2,0 mm
 13-039-004 ø 2,5 mm
 13-039-005 ø 3,0 mm
 13-039-006 ø 3,5 mm
 13-039-007 ø 4,0 mm
 13-039-008 ø 4,5 mm
 13-039-009 ø 5,0 mm

Aorta Dilators

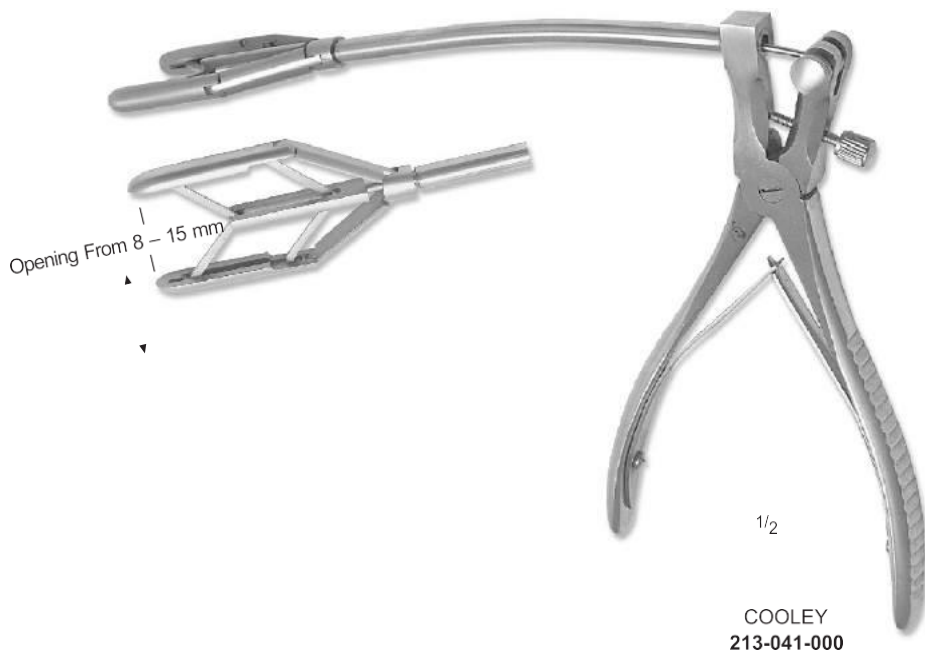
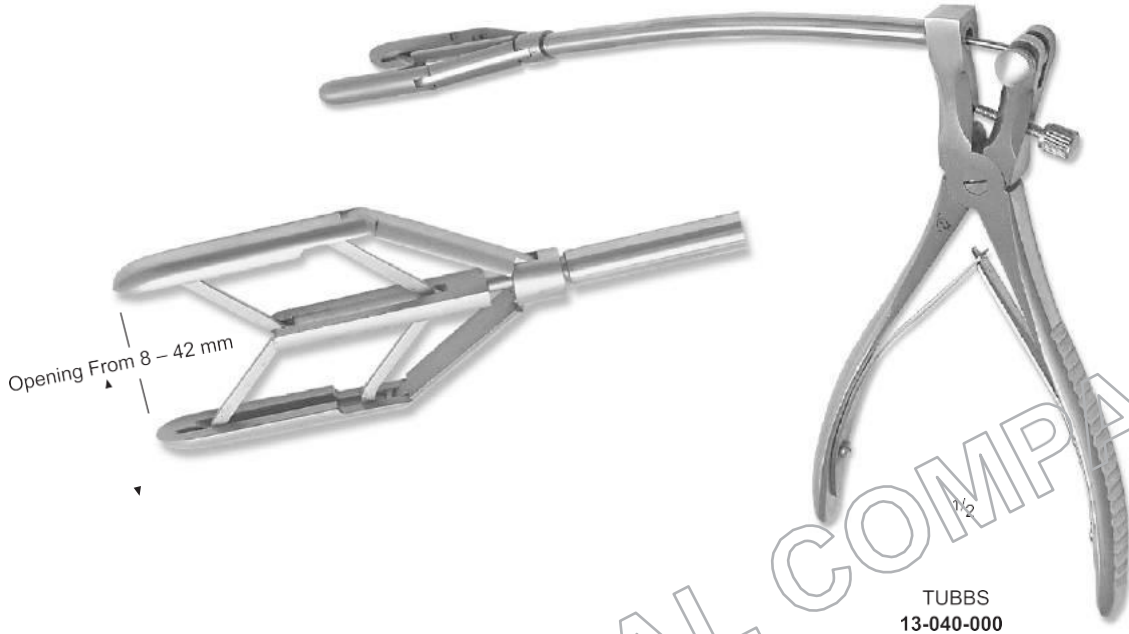

Vascular Scissors, with Tungsten Carbide T/C Inserts

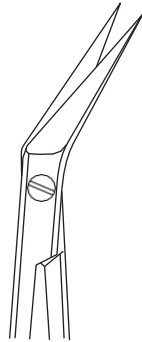

13-042-025
 25°

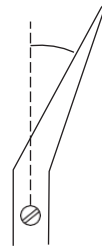

13-043-025
 25°

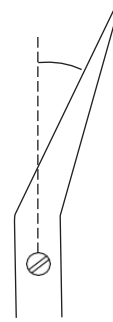

13-044-025
 25°

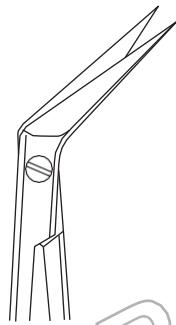

13-042-045
 45°

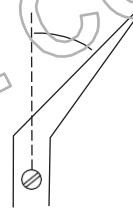

13-043-045
 45°

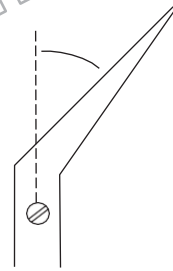

13-044-045
 45°

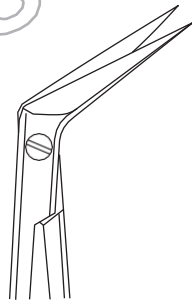

1/1
 13-042-060
 60°

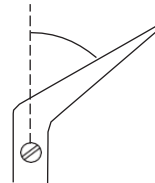

1/1
 13-043-060
 60°

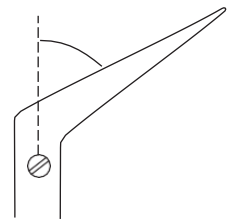

13-044-060
 60°

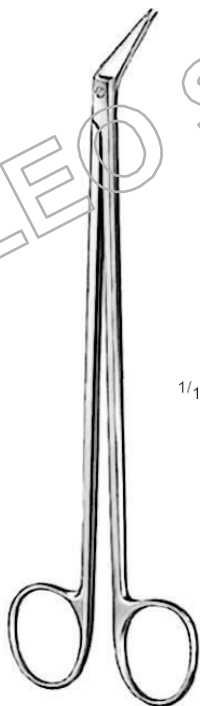

POTTS SMITH
 19 cm / 7 1/2"

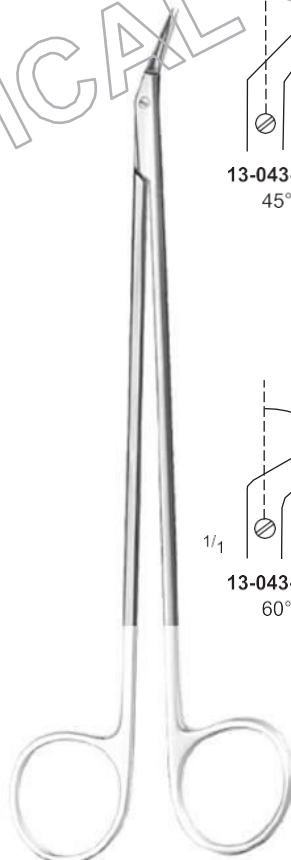

POTTS SMITH, T/C
 19 cm / 7 1/2"
 23 cm / 9"

LEO SURGICAL COMPANY

Vascular Scissors

LEO SURGICAL COMPANY

