

NASAL Instruments

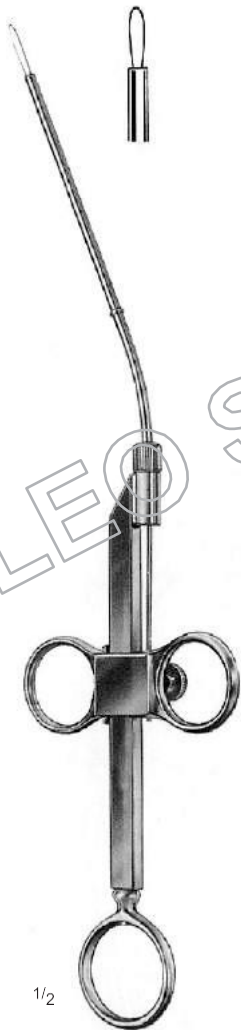

Sinus Wash Canulae, Nasal Snares



1/2

KRAUS
21-001-260
26 cm / 10 1/4"

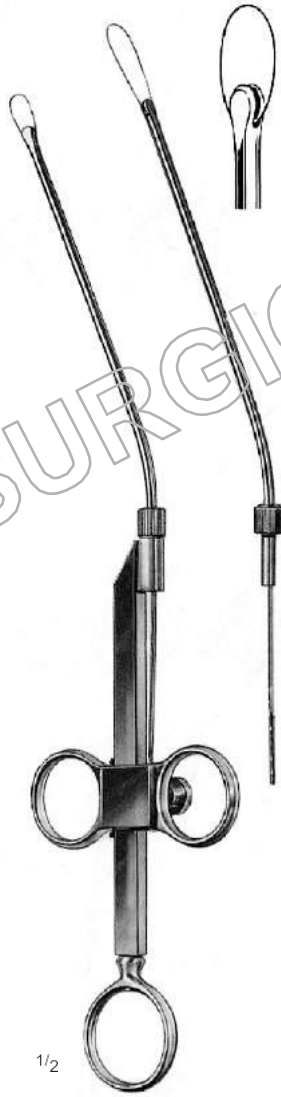

1/2

KRAUS VOSS
21-002-260
26 cm / 10 1/4"



Ø 3 mm

1/2

1/2

EICKEN-KILLIAN
21-004-140
14 cm / 5 1/2"

SIEBENMANN
21-005-001 = ø 1.5 mm
21-005-002 = ø 1.7 mm
21-005-003 = ø 2.0 mm
21-005-004 = ø 2.5 mm
21-005-005 = ø 3.0 mm



21-003-003 – 0.3 mm ø
21-003-004 – 0.4 mm ø
Coil / 10 metre



21-004-000
0.3 mm ø
Package / 100

Dressing and Polypus Forceps

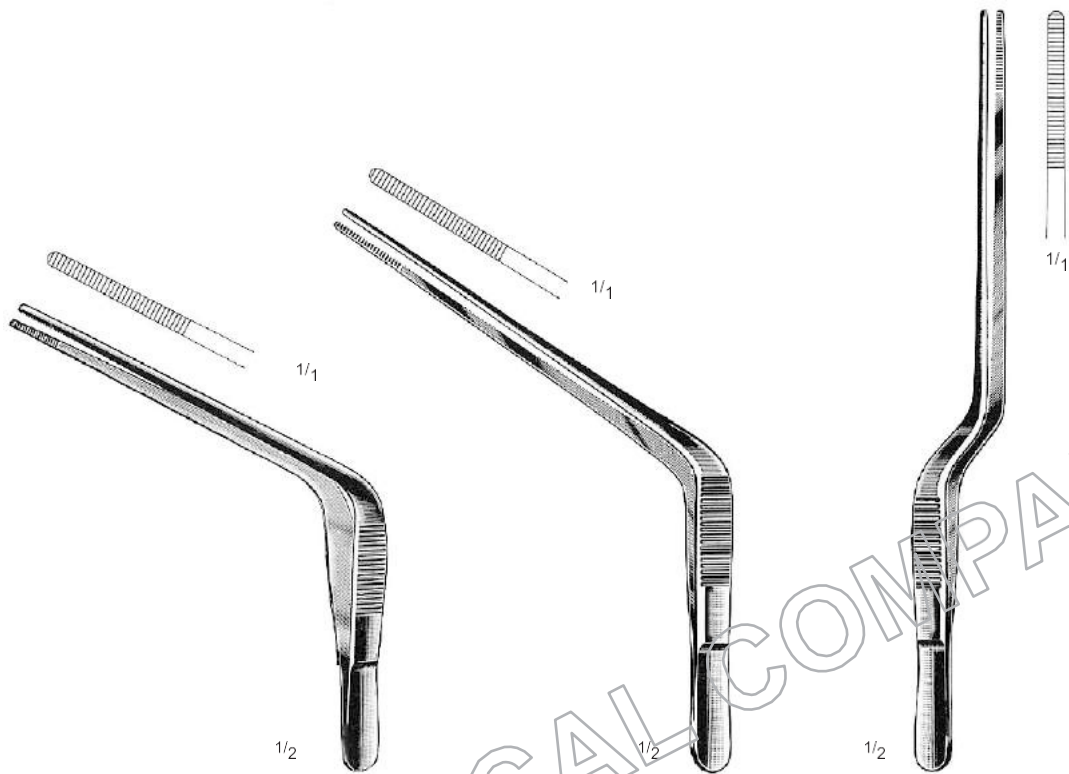

TROELTSCH
21-006-150
15 cm / 6"

TROELTSCH
21-007-180
18 cm / 7"

GRUENWALD (JANSEN)
21-008-200
20 cm / 8"

Delicate

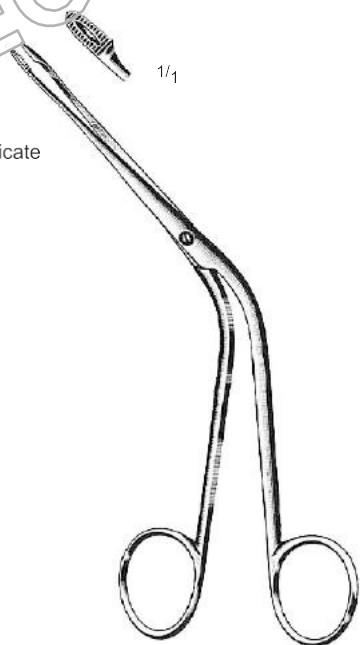

HARTMANN
21-009-160
16 cm / 6 1/4"

Standard

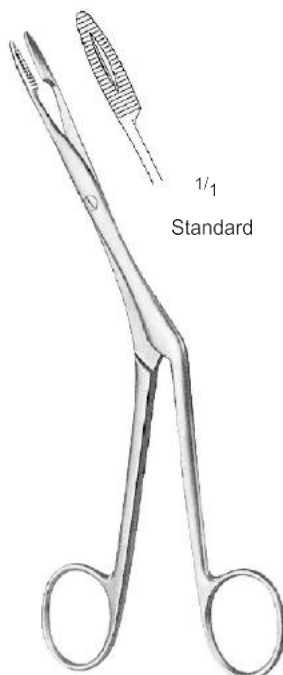

HARTMANN
21-010-200
20 cm / 8"



TILLEY
21-011-170
17 cm / 6 3/4"

Nasal Specula

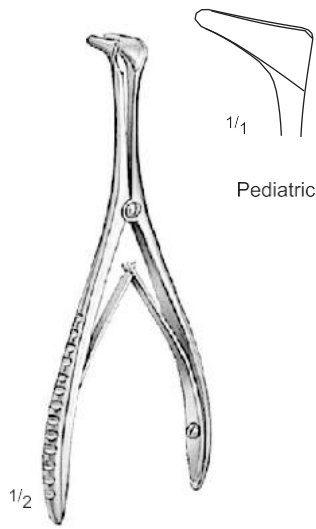

Pediatric

PROFESSIONAL
 21-012-130
 13 cm / 5"

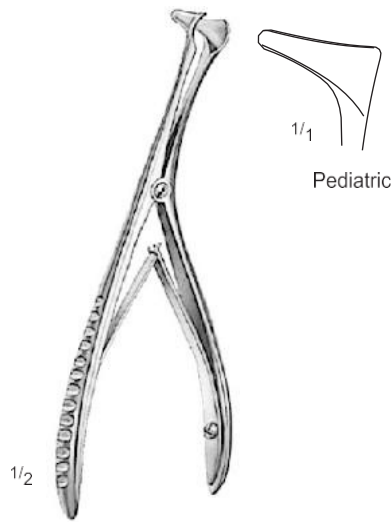

Pediatric

PROFESSIONAL
 21-013-130
 13 cm / 5"

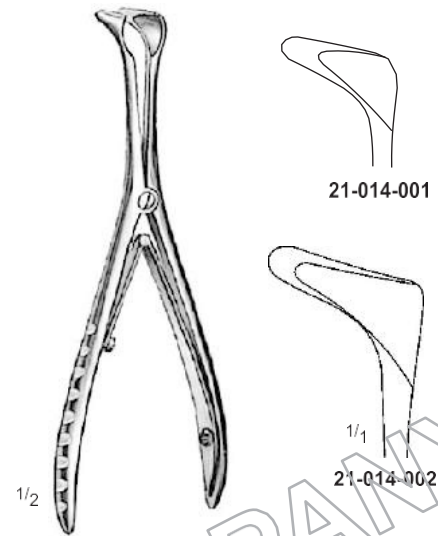

TIECK-HALLE
 21-014-001
 13.5 cm / 5 1/4"

21-014-002

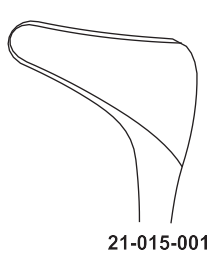

21-015-001

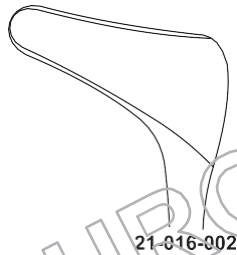

21-016-002

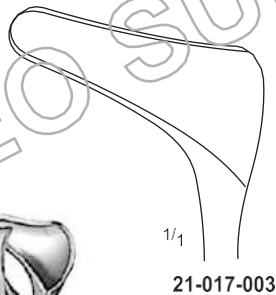

21-017-003

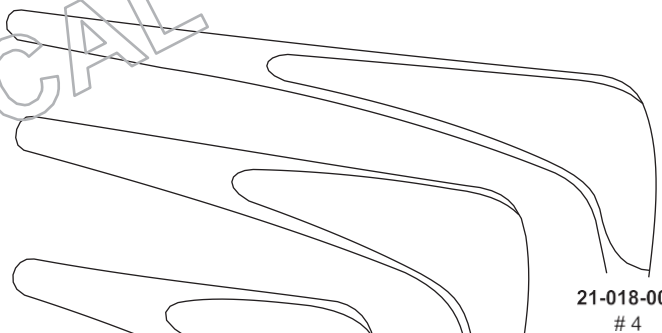

21-018-004
 # 4

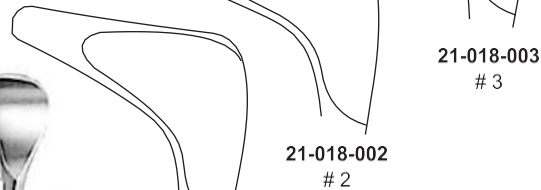

21-018-003
 # 3

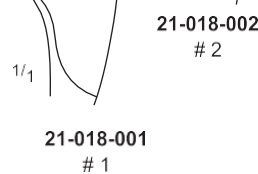

21-018-002
 # 2

21-018-001
 # 1

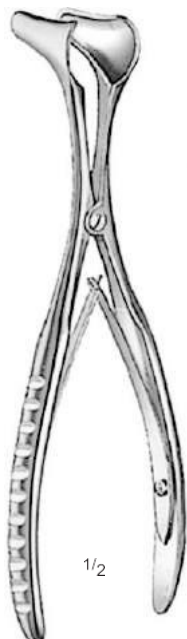

HARTMANN-HALLE
 15 cm / 6"



COTTLE
 15 cm / 6"

Nasal Specula

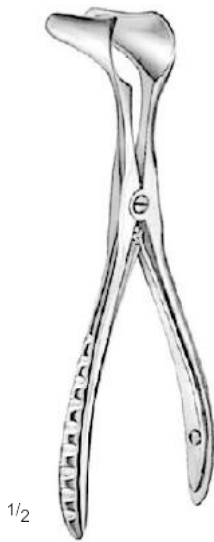

KILLIAN
14 cm / 5 1/2"

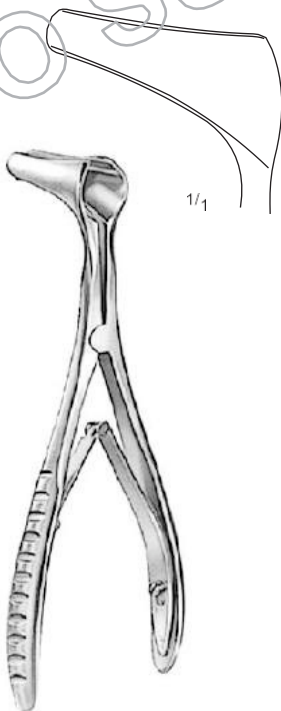
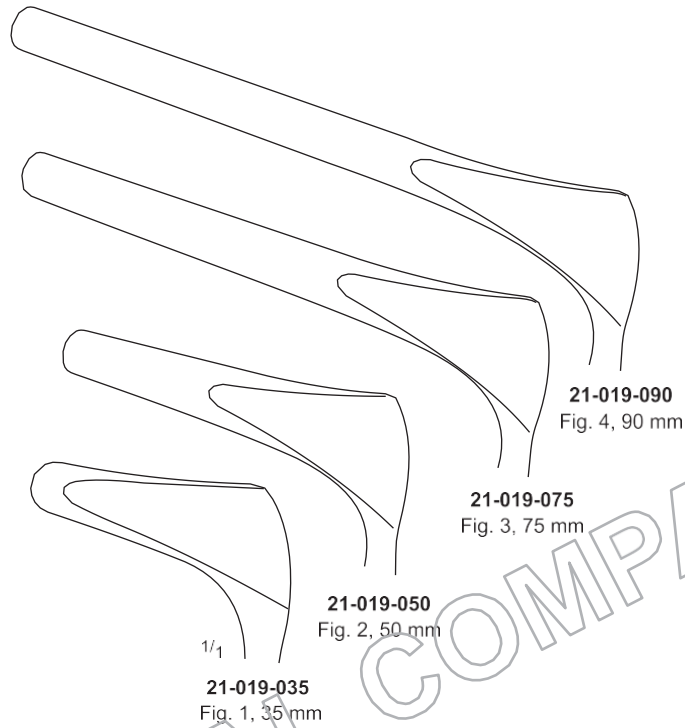

VIENNA PATTERN
21-021-150
15 cm / 6"

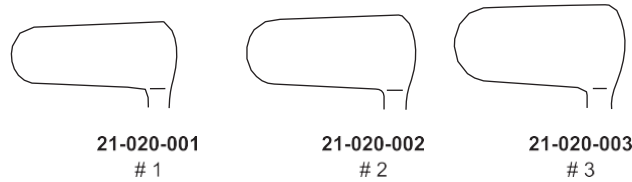

GOLDSMITH (THUDICUM)
6.5 cm / 2 1/2"

Nasal Scissors, Septum Knives, Septum Elevators

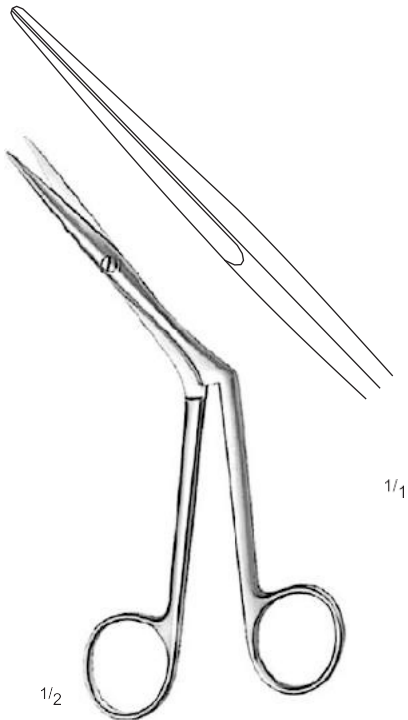

HEYMANN-KNIGHT
21-022-180
18 cm / 7"

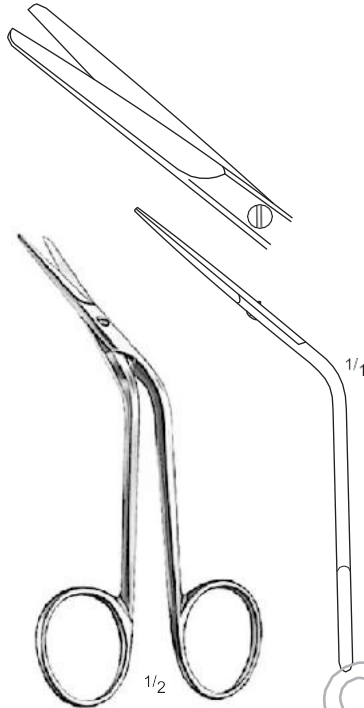

FOMON
21-023-150
15 cm / 6"

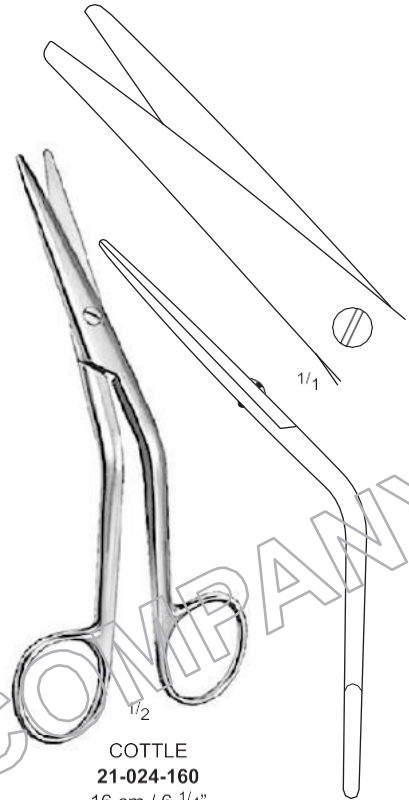

COTTLE
21-024-160
16 cm / 6 1/4"



BLALENGER
20 cm / 8"



21-025-003
3.0 mm

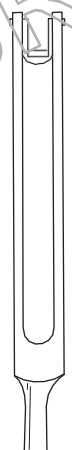

21-025-004
4.0 mm



21-025-005
5.0 mm

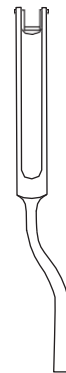

BLALENGER
Bayonet Shape
21-026-200
20 cm / 8"

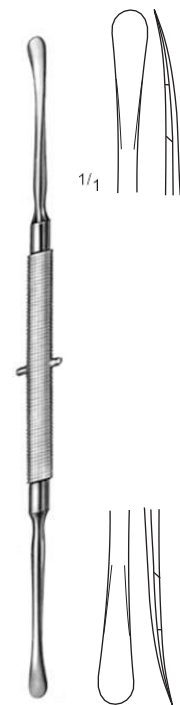

FREER
21-027-210
21 cm / 8 1/4"

Septum Elevators, Compression Forceps

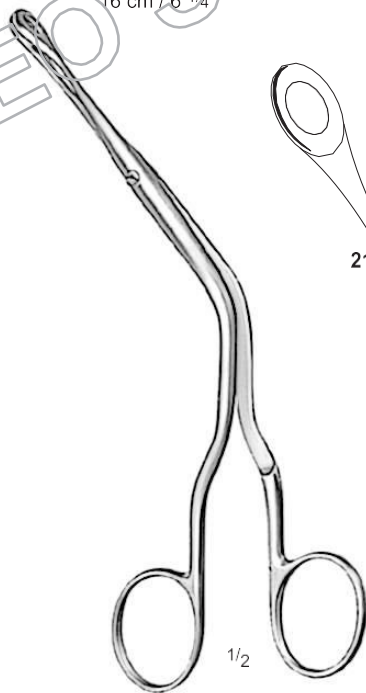
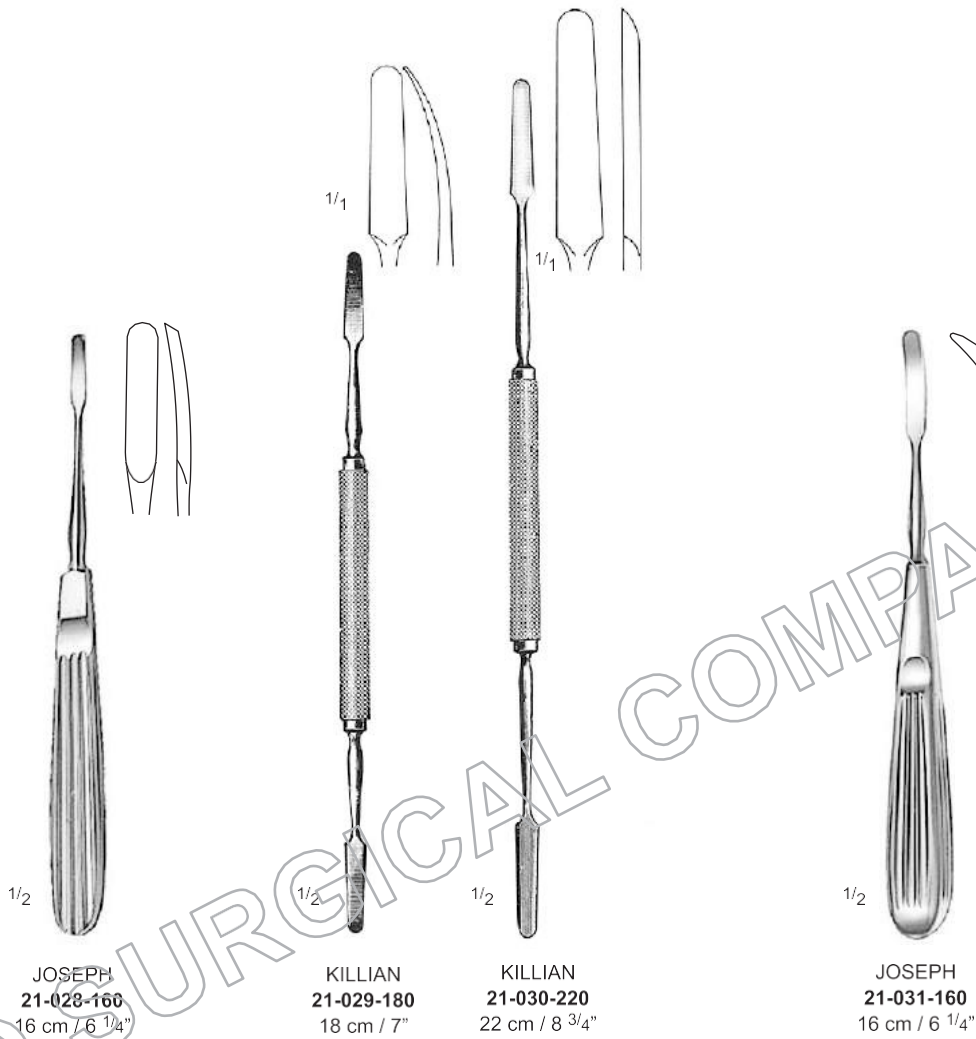

LUC
20 cm / 8"

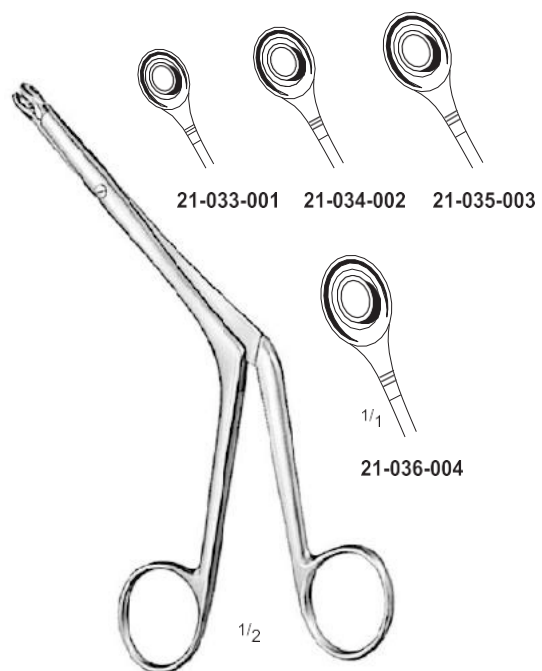

BRUENINGS
19 cm / 7 1/2"

Nasal Cutting Forceps

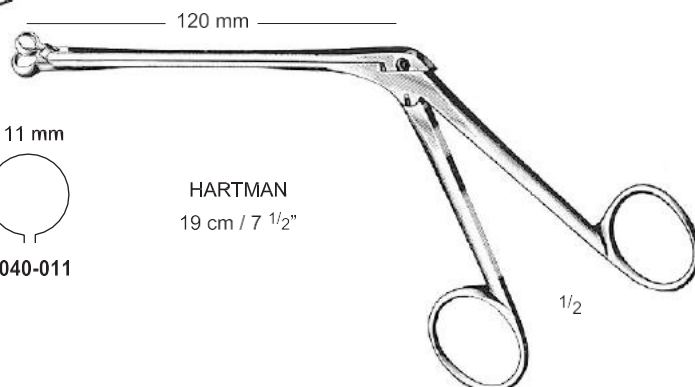
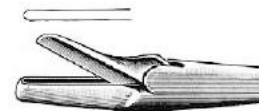
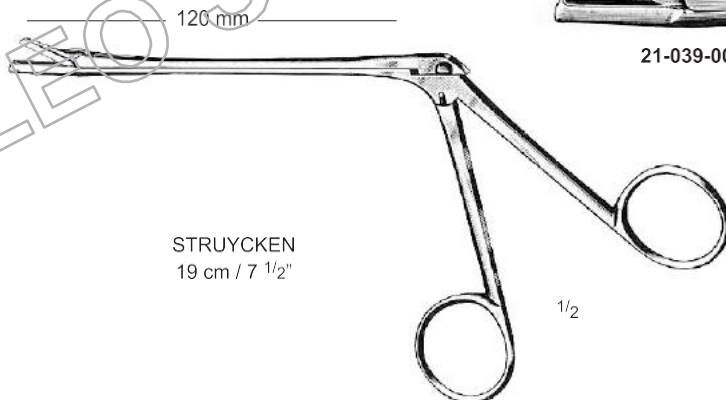
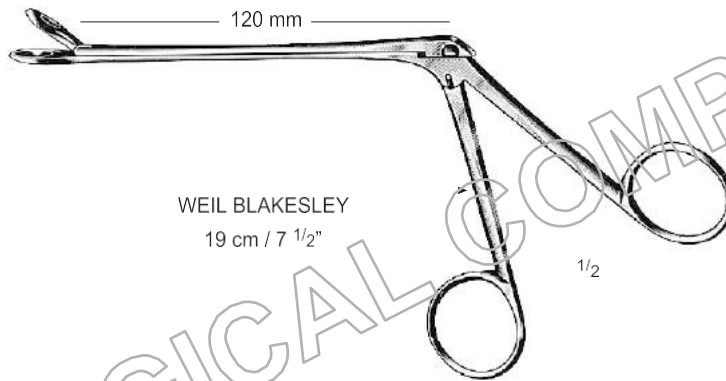

Septum Compression Forceps, Punch Forceps, Rhinoplastic Instruments



JANSEN MIDDLETON
21-042-190
19 cm / 7 1/2"

- 3 mm
21-043-003
- 4 mm
21-043-004
- 5 mm
21-043-005
- 6 mm
21-043-006



KERRISON
20 cm / 8"



FOMON
21-044-150
15 cm / 6"



JOSEPH
21-045-150
15 cm / 6"



CONVERSE
21-046-120
12 cm / 4 3/4"

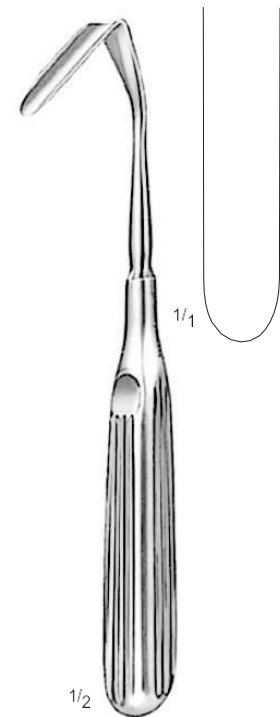

AUFRECHT
21-047-190
19 cm / 7 1/2"

Rhinoplastic Instruments

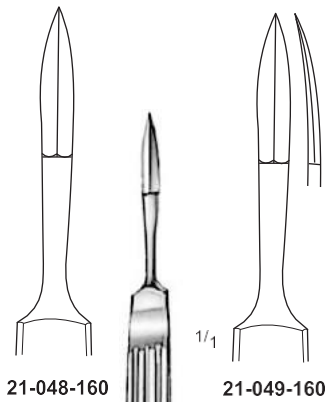

21-048-160

21-049-160

1/2

JOSEPH
16 cm / 6 1/4"

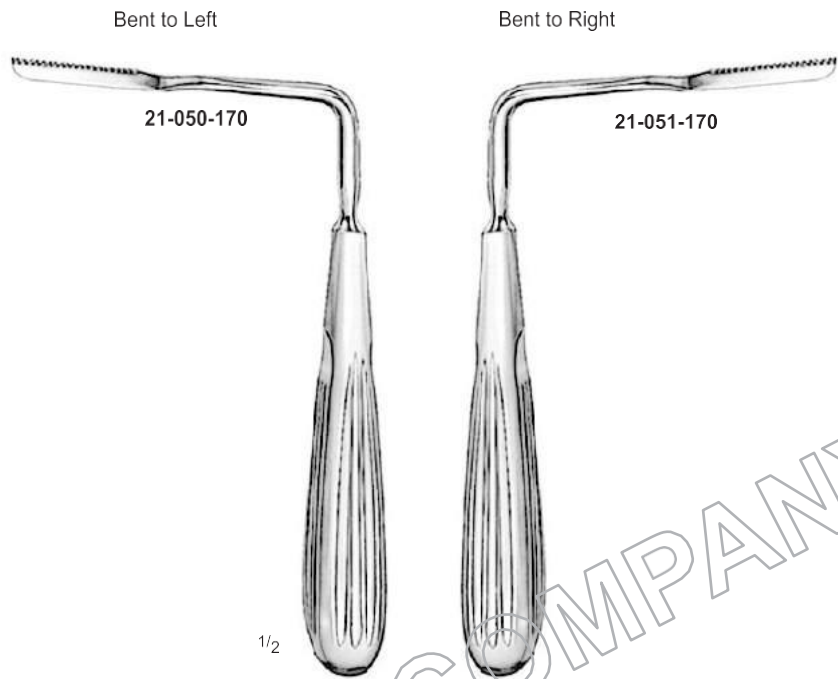

Bent to Left

Bent to Right

21-050-170

21-051-170

1/2

JOSEPH
17 cm / 6 3/4"

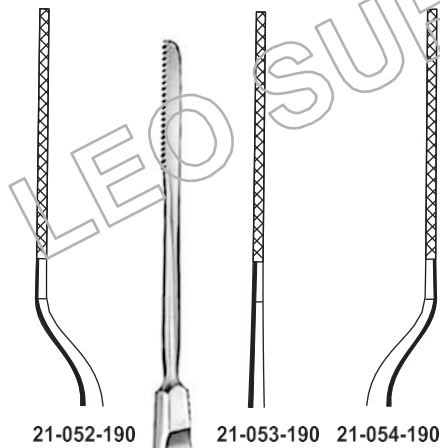

21-052-190

21-053-190

21-054-190

1/2

JOSEPH
19 cm / 7 1/2"

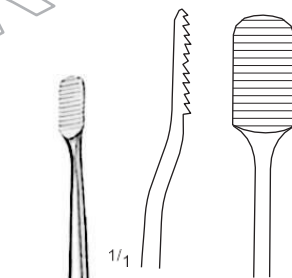

1/1

1/2

LEWIS
21-055-180
18 cm / 7"

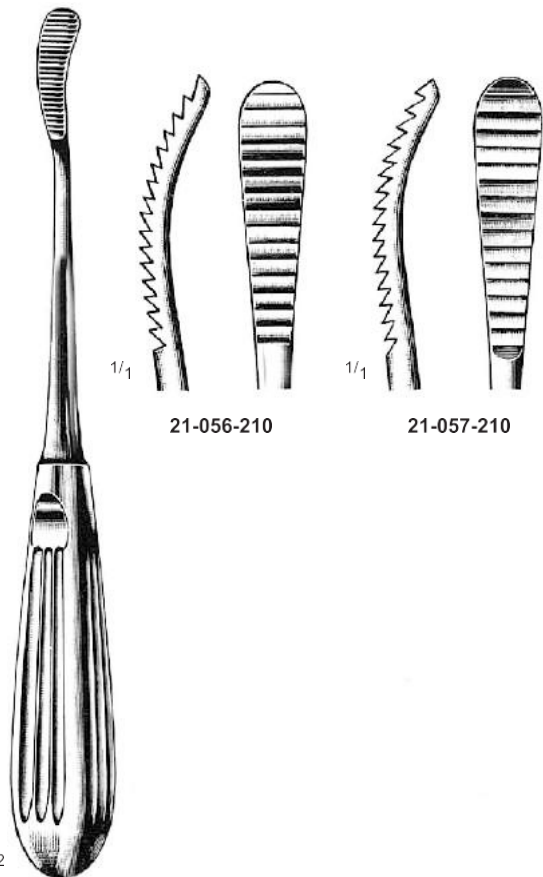

1/1

1/1

21-056-210

21-057-210

1/2

AUFRICHT
21 cm / 8 1/4"

Rhinoplastic Instruments

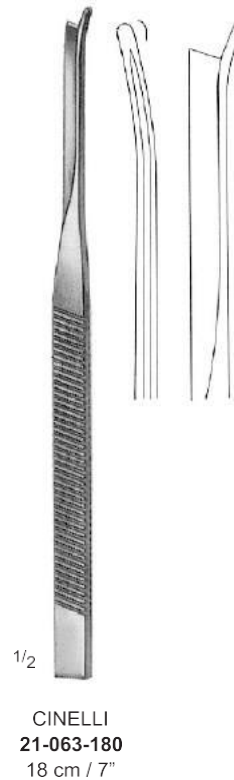
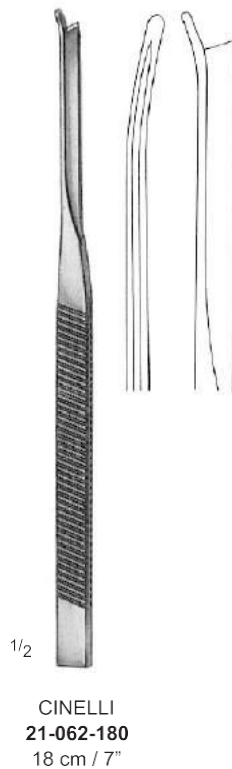
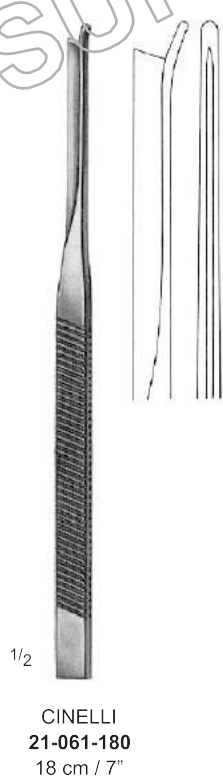
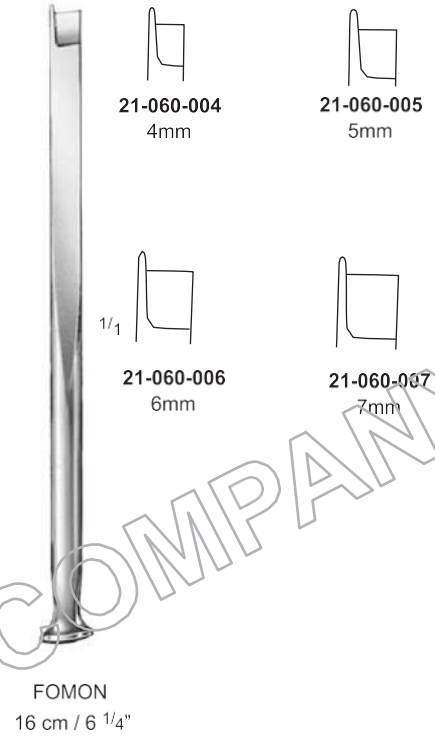
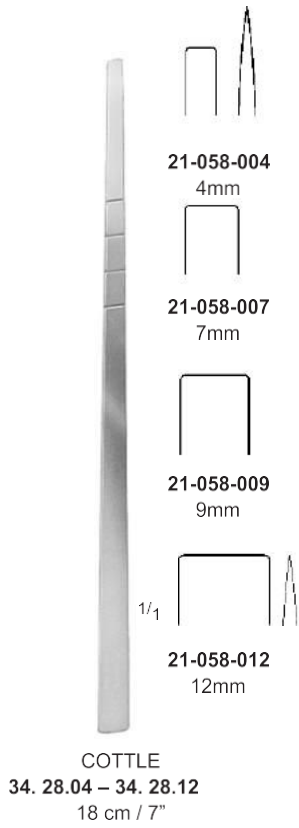

Septum Forceps

