



Serving the Humanity Since 1969

**NEURO**

**INSTRUMENTS**

**CATALOGUE ADDITION - 07**



*SURGICAL INNOVATION  
IS OUR PASSION*



**LEO SURGICAL COMPANY**  
ISO : 13485:2016 | SSI | MSME | CE CERTIFIED



*Leo Surgical Company was established by Sh. Kartar Chand Ji in 1969 with Aim to Provide high quality surgical instruments to his customers for better results in medical line. He worked hard on the precision of instruments. Due to his personal involvement in the production he sets new standards in the quality of surgical instruments. He started the company with a low scale production, but due to his hard work, Leo Surgical Company has touched the new heights of success and now is well reknowned brand in surgical line.*

*In our factory we have been served by highly skilled labourers, and great combination of skilled labourers, latest technology and foresightness of Sh. Kartar Chand Ji, we lay claim to be among the leading manufacturers of surgical instruments in the region.*

*In this second edition of our catalogue we hope that you will find the great variety of surgical instruments which will cover all the surgeries.*

For LEO SURGICAL COMPANY

Vipan Yadav

Prop.

## SCALPEL HANDLES



## SUCTION TUBES

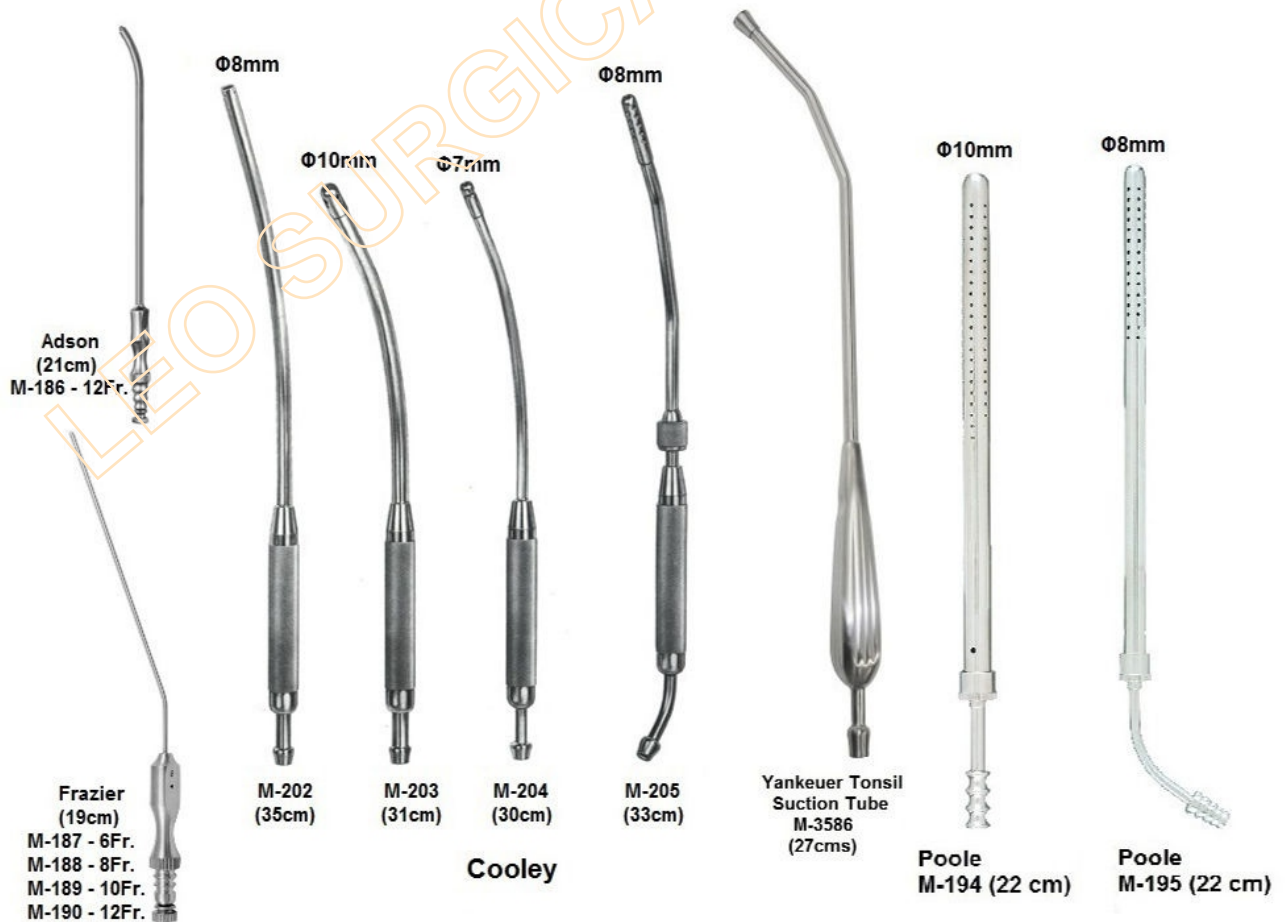

# DRESSING FORCEPS

## Standard



M-424	M-425	M-426	M-427	M-428
10.5cm	11.5cm	13 cm	14.5cm	15 cm
M-429	M-430	M-431	M-432	M-433
16 cm	18 cm	20 cm	25 cm	30 cm

## Slender



M-434	M-435	M-436	M-437	
10.5cm	11.5cm	13 cm	14.5 cm	
M-438	M-439	M-440	M-441	M-442
16 cm	18 cm	20 cm	25 cm	30 cm

## Slender



M-443	M-444	M-445	M-446	
10.5cm	11.5cm	13 cm	14.5cm	
M-447	M-448	M-449	M-450	M-451
16 cm	18 cm	20 cm	25 cm	30 cm

## Adson



M-470	M-471
12 cm	15 cm

## Micro-Adson



M-472	M-473
12 cm	15 cm

## Russian

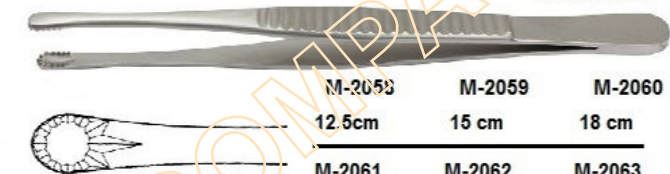

M-2058	M-2059	M-2060
12.5cm	15 cm	18 cm
M-2061	M-2062	M-2063
20 cm	23 cm	25 cm



**Taylor**  
M-480  
17.5 cm



M-481  
17.5 cm



**Taylor**  
M-482  
18.5 cm



**Cushing**  
M-485  
18 cm



M-486  
18 cm



**Potts - Smith**  
M-487  
18 cm

M-488  
21 cm

M-489  
25 cm



**Potts - Smith**  
M-490  
18 cm

M-491  
21 cm

M-492  
25 cm

# TISSUE FORCEPS

**Standard**

1:2

- M-544 (10.5 cm)
- M-545 (11.5 cm)
- M-546 (13.0 cm)
- M-547 (14.5 cm)
- M-548 (15.0 cm)
- M-549 (16.0 cm)
- M-550 (18.0 cm)
- M-551 (20.0 cm)
- M-552 (25.0 cm)
- M-553 (30.0 cm)

**Standard**

2:3

- M-554 (11.5 cm)
- M-555 (13.0 cm)
- M-556 (14.5 cm)
- M-557 (16.0 cm)
- M-558 (18.0 cm)
- M-559 (20.0 cm)
- M-560 (25.0 cm)
- M-561 (30.0 cm)

**Standard**

3:4

- M-562 (13.0 cm)
- M-563 (14.5 cm)
- M-564 (16.0 cm)
- M-565 (18.0 cm)
- M-566 (20.0 cm)

**Adson Forceps**

M-572 (12cm)  
M-573 (15cm)

**Micro-Adson Forceps**

M-574 (12.0 cm)  
M-575 (15.0 cm)

**Adson - Brown**

M-578 (12.0 cm)

**Cushing**

M-542  
18 cm

**Taylor**

M-583  
(17.5 cm)

**Taylor**

M-584  
(18.5 cm)

**De Bakey**

**3.5mm**

- M-640 (15 cm)
- M-641 (20 cm)
- M-642 (24 cm)
- M-643 (30 cm)

**2.8mm**

- M-651 (15 cm)
- M-652 (20 cm)
- M-653 (24 cm)
- M-654 (30 cm)

**2mm**

- M-648 (15 cm)
- M-649 (20 cm)
- M-650 (24 cm)

**1.5mm**

- M-646 (15 cm)
- M-647 (20 cm)

**1.0mm**

- M-2127 - 12.5cms
- M-2128 - 15cms
- M-2129 - 18cms
- M-2130 - 20cms
- M-2131 - 24cms
- M-2132 - 28cms
- M-2133 - 30cms

**2mm**

- M-644 (15 cm)
- M-645 (20 cm)

**1.0mm**

- M-2234 - 15cms
- M-2235 - 20cms
- M-2236 - 24cms

# OPERATING SCISSORS

Straight

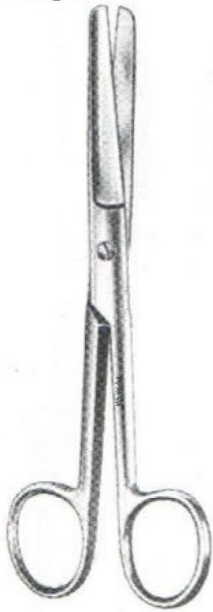

Straight



Straight



Curved



Curved

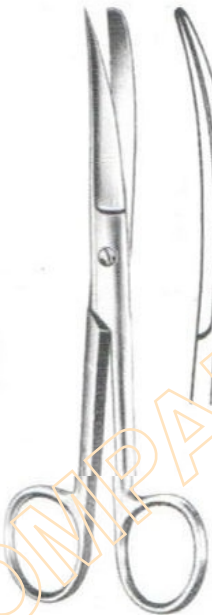

Curved

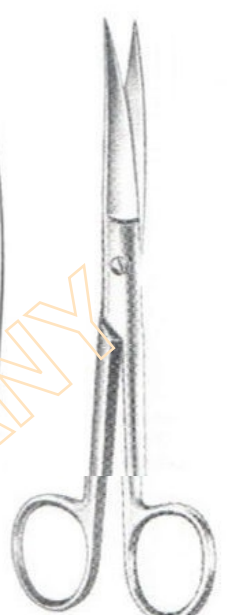

**STANDARD**

- M-241 (10.5 cm)
- M-242 (11.5 cm)
- M-243 (13.0 cm)
- M-244 (14.5 cm)
- M-245 (15.5 cm)
- M-246 (16.5 cm)
- M-247 (17.5 cm)
- M-248 (18.5 cm)
- M-249 (20.0 cm)

**STANDARD**

- M-250 (10.5 cm)
- M-251 (11.5 cm)
- M-252 (13.0 cm)
- M-253 (14.5 cm)
- M-254 (15.5 cm)
- M-255 (16.5 cm)
- M-256 (17.5 cm)
- M-257 (18.5 cm)
- M-258 (20.0 cm)

**STANDARD**

- M-259 (10.5 cm)
- M-260 (11.5 cm)
- M-261 (13.0 cm)
- M-262 (14.5 cm)
- M-263 (15.5 cm)
- M-264 (16.5 cm)
- M-265 (17.5 cm)
- M-266 (18.5 cm)
- M-267 (20.0 cm)

**STANDARD**

- M-268 (10.5 cm)
- M-269 (11.5 cm)
- M-270 (13.0 cm)
- M-271 (14.5 cm)
- M-272 (15.5 cm)
- M-273 (16.5 cm)
- M-274 (17.5 cm)
- M-275 (18.5 cm)
- M-276 (20.0 cm)

**STANDARD**

- M-277 (10.5 cm)
- M-278 (11.5 cm)
- M-279 (13.0 cm)
- M-280 (14.5 cm)
- M-281 (15.5 cm)
- M-282 (16.5 cm)
- M-283 (17.5 cm)
- M-284 (18.5 cm)
- M-285 (20.0 cm)

**STANDARD**

- M-286 (10.5 cm)
- M-287 (11.5 cm)
- M-288 (13.0 cm)
- M-289 (14.5 cm)
- M-290 (15.5 cm)
- M-291 (16.5 cm)
- M-292 (17.5 cm)
- M-293 (18.5 cm)
- M-294 (20.0 cm)

Toennis  
(Curved)  
M-374 (18 cm)

Toennis  
(Straight)  
M-373 (18 cm)

Toennis - Adson  
M-375 (17.5 cm)

Olivercrona  
M-376 (23 cm)

Mayo  
Straight  
M-305 (14.5 cm)  
M-306 (15.0 cm)  
M-307 (17.0 cm)  
M-307-A (19.0 cm)  
M-308 (23.0 cm)

Mayo  
Curved  
M-309 (15.0 cm)  
M-310 (17.0 cm)  
M-311 (19.0 cm)  
M-312 (23.0 cm)

# DISSECTING SCISSORS



## IRIS SCISSORS

# ARTERY FORCEPS



**Halsted Mosquito**  
M-732 to M-739

- M-732 (16.0 cm)
- M-733 (18.0 cm)
- M-734 (16.0 cm)
- M-735 (18.0 cm)

**Mosquito**  
M-740 to M-747

- M-740 (10.5 cm)
- M-741 (12.5 cm)
- M-742 (10.5 cm)
- M-743 (12.5 cm)

**Roberts Artery Forceps (Serrated)**

- M-1982 (13cm)
- M-1983 (15cm)
- M-1984 (16cm)
- M-1985 (20cm)
- M-1986 (23cm)
- M-1987 (25cm)
- M-1988 (28cm)
- M-1989 (30cm)
- M-1990 (13cm)
- M-1991 (15cm)
- M-1992 (18cm)
- M-1993 (20cm)
- M-1994 (23cm)
- M-1995 (25cm)
- M-1996 (28cm)
- M-1997 (30cm)

**Crile**  
M-748 to M-749

- O-748 14cm
- O-749 14cm

**Pean (Rochester)**  
M-750 to M-765

- M-750 (14 cm)
- M-751 (16 cm)
- M-752 (18 cm)
- M-753 (20 cm)
- M-754 (22 cm)
- M-755 (24 cm)
- M-756 (26 cm)
- M-757 (28 cm)
- M-758 (14 cm)
- M-759 (16 cm)
- M-760 (18 cm)
- M-761 (20 cm)
- M-762 (22 cm)
- M-763 (24 cm)
- M-764 (26 cm)
- M-765 (28 cm)

**Kocher (Rochester)**  
M-766 to M-781

- M-766 (14 cm)
- M-767 (16 cm)
- M-768 (18 cm)
- M-769 (20 cm)
- M-770 (22 cm)
- M-771 (24 cm)
- M-772 (26 cm)
- M-773 (30 cm)
- M-774 (14 cm)
- M-775 (16 cm)
- M-776 (18 cm)
- M-777 (20 cm)
- M-778 (22 cm)
- M-779 (24 cm)
- M-780 (26 cm)
- M-781 (30 cm)

**Hartmann**  
M-802 to M-803 (10 cm)

- M-802
- M-803



# ARTERY FORCEPS

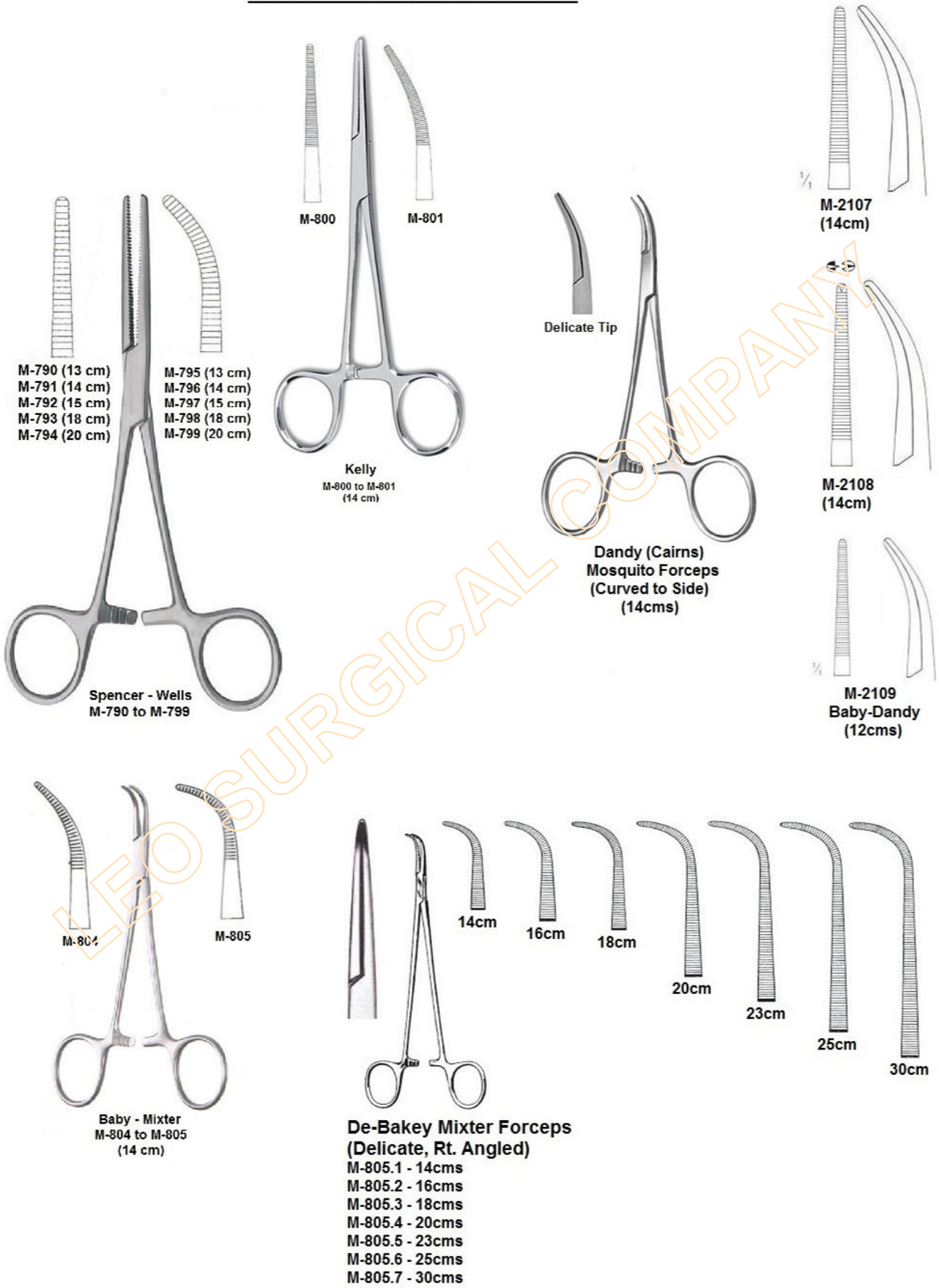

**Spencer - Wells**  
M-790 (13 cm)  
M-791 (14 cm)  
M-792 (15 cm)  
M-793 (18 cm)  
M-794 (20 cm)

M-795 (13 cm)  
M-796 (14 cm)  
M-797 (15 cm)  
M-798 (18 cm)  
M-799 (20 cm)

**Kelly**  
M-800 to M-801  
(14 cm)

**Dandy (Cairns) Mosquito Forceps (Curved to Side)**  
(14cms)

**M-2107**  
(14cm)

**M-2108**  
(14cm)

**M-2109 Baby-Dandy**  
(12cms)

**Baby - Mixer**  
M-804 to M-805  
(14 cm)

**De-Bakey Mixer Forceps (Delicate, Rt. Angled)**  
M-805.1 - 14cms  
M-805.2 - 16cms  
M-805.3 - 18cms  
M-805.4 - 20cms  
M-805.5 - 23cms  
M-805.6 - 25cms  
M-805.7 - 30cms

# NEEDLE HOLDERS

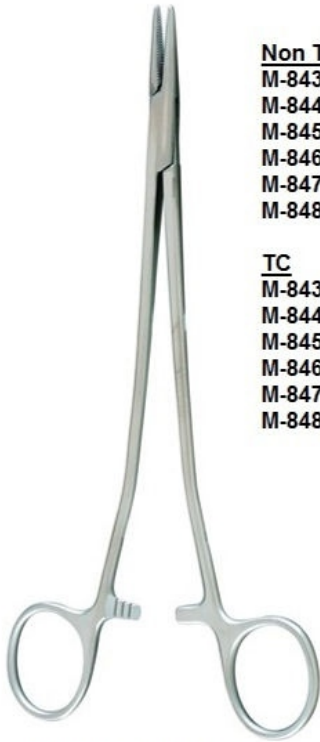

**Sarot Needle Holder**  
(TC & Non TC)

**Non TC**

- M-843S - 14cm
- M-844S - 16cm
- M-845S - 18cm
- M-846S - 20cm
- M-847S - 24cm
- M-848S - 26cm

**TC**

- M-843ST - 14cm
- M-844ST - 16cm
- M-845ST - 18cm
- M-846ST - 20cm
- M-847ST - 24cm
- M-848ST - 26cm

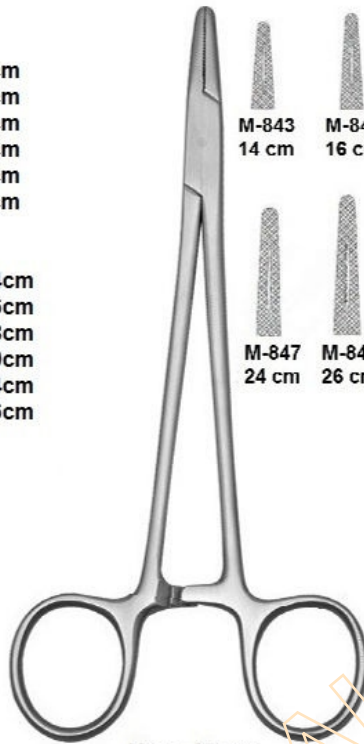

**Mayo - Hegar**  
M-843 to M-849  
(TC & Non-TC)

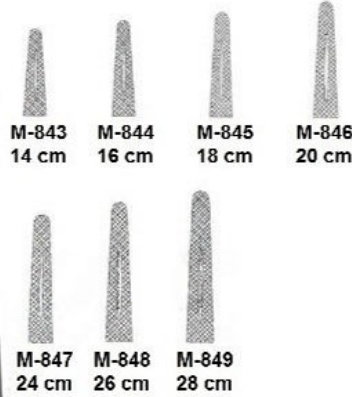

**Kilner**



- M-843B (14cm)
- M-844B (16cm)
- M-845B (18cm)
- M-846B (20cm)
- M-847B (24cm)
- M-848B (26cm)

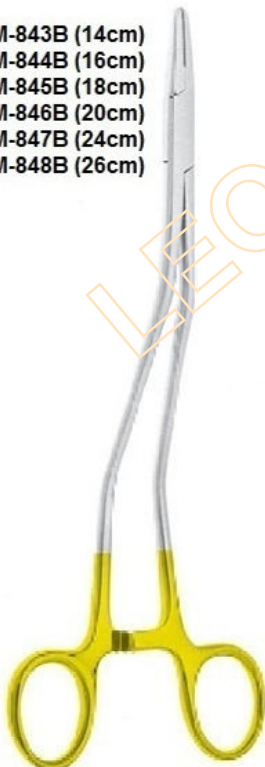

**Bozeman Angled Needle Holders**  
(TC & Non-TC)



**Debakey Needle Holder**  
(TC & Non-TC)

- M-839.1 (13cm)
- M-839.2 (15cm)
- M-839.3 (18cm)
- M-839.4 (21cm)
- M-839.5 (23cm)
- M-839.6 (25cm)
- M-839.7 (30cm)

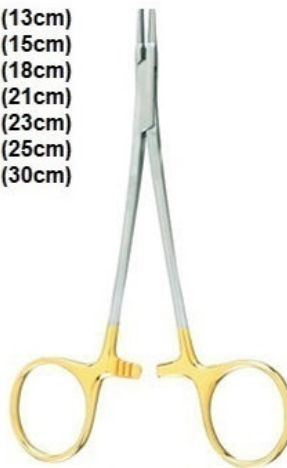

**Ryder Needle Holder**  
(Regular & Mini)  
(TC & Non-TC)

**REGULAR**

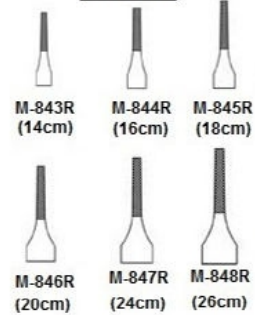

**MINI (Vascular)**

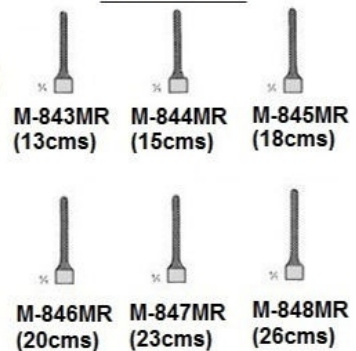

## NEEDLE HOLDERS

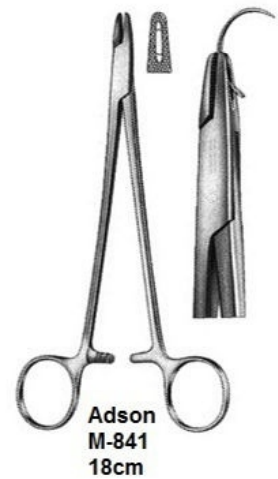

# MICRO NEEDLE HOLDERS



Curved

	Size	Without Lock	With Lock
Straight	14cm	M-823	M-823L
	18cm	M-823.1	M-823L.1
	20cm	M-823.2	M-823L.2
	23cm	M-823.3	M-823L.3
Curved	14cm	M-824	M-824L
	18cm	M-824.1	M-824L.1
	20cm	M-824.2	M-824L.2
	23cm	M-824.3	M-824L.3



M-876  
16cm

M-877 23cm M-878 23cm M-879 19cm

Castroviejo Needle Holder  
(Spring Type, Flat Handle)



M-875T (TC)  
M-875

Mathieu Micro Bayonet Needle Holder



Mathieu

M-872  
14cm

M-873  
17cm

M-874  
20cm

Lichtenberg  
(20cm)



Mathieu

M-880 14cm M-881 17cm

M-882 19cm M-883 21cm



Castroviejo  
M-820  
(13cm)

M-821 M-822



Arruga  
(16cm)

TC & Non TC

# MICRO SCISSORS

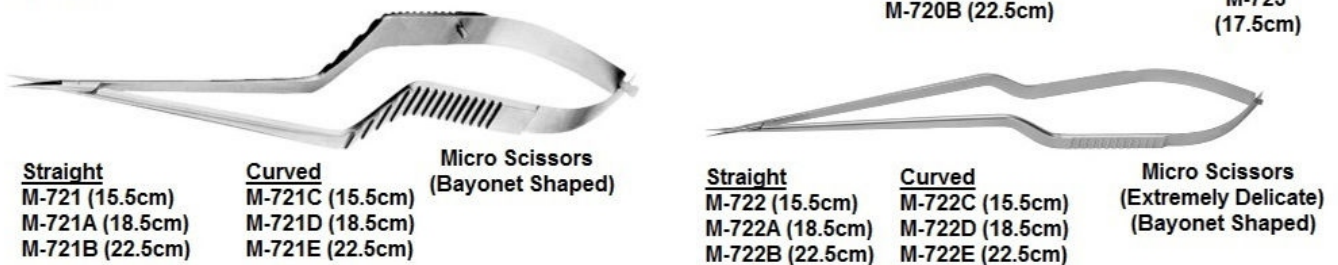
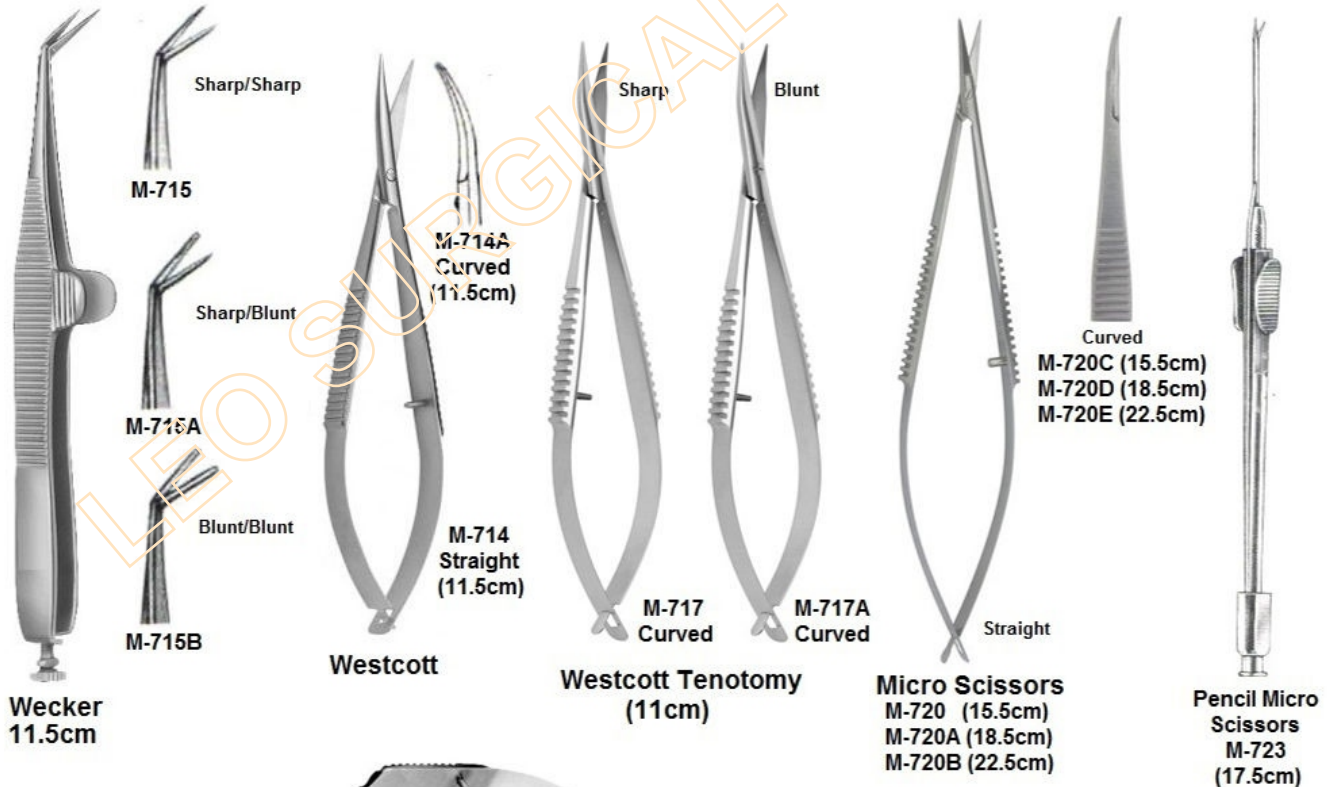
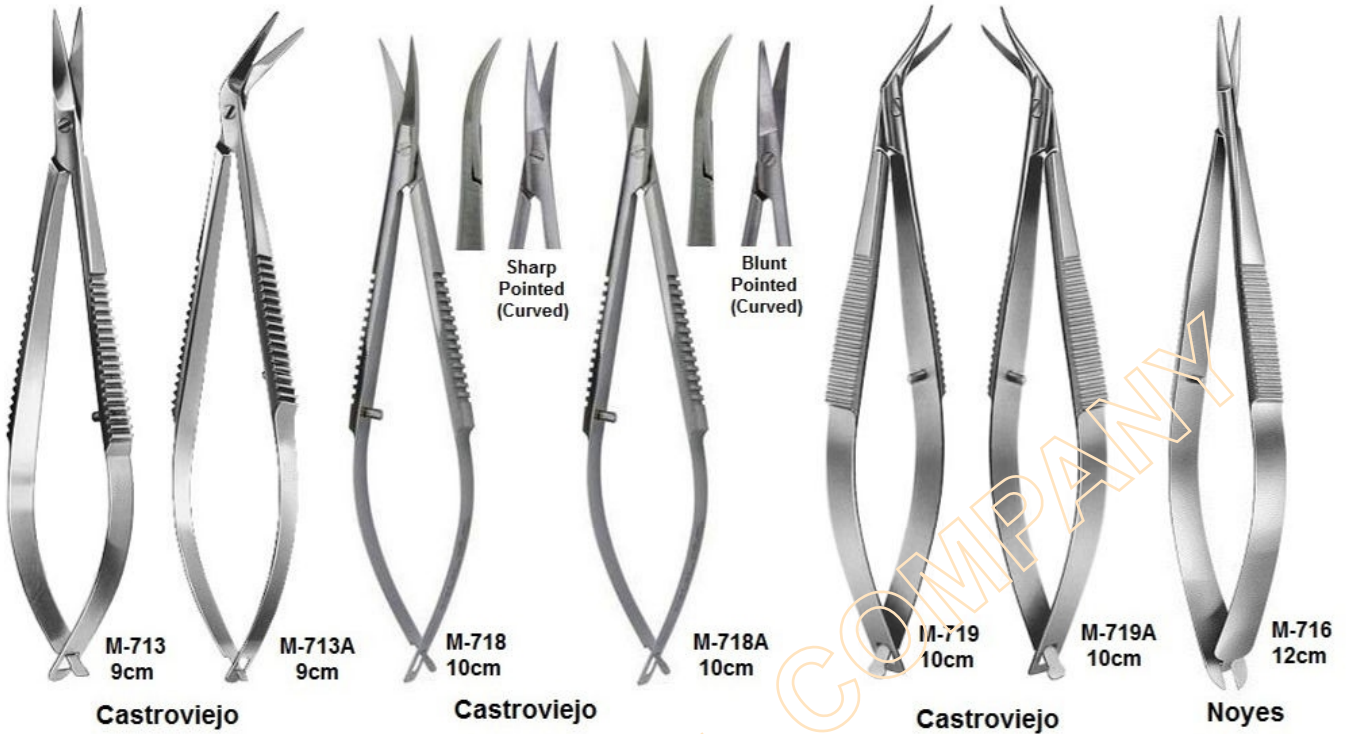

# MICRO SCISSORS



**M-2171**  
25°  
Angled Blade



**M-2172**  
45°  
Angled Blade



**M-2173**  
60°  
Angled Blade



**M-2174**  
90°  
Angled Blade



**M-2175**  
125°  
Angled Blade



**M-2176**  
V-Neck 125°  
Angled Blade



**Jacobson Coronary  
Micro Scissors  
(Flat Handle, 16.5cm)**



**M-2177**  
25°  
Angled Blade



**M-2178**  
45°  
Angled Blade



**M-2179**  
60°  
Angled Blade

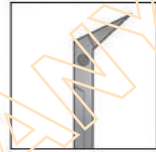

**M-2180**  
90°  
Angled Blade



**M-2181**  
125°  
Angled Blade



**M-2182**  
V-Neck 125°  
Angled Blade



**Jacobson Coronary  
Micro Scissors  
(Round Handle, 16.5cm)**



**M-723A.1  
(Curved)  
(18cm)**



Tip & outside surfaces of the blades rounded

**M-723C  
(Curved)  
(18cm)**

**M-723A  
Straight  
(18cm)**

**M-723B  
Straight  
(18cm)**



**Potts-Smiths  
(19cms)**



25°

**M-418PA**



40°

**M-418PB**

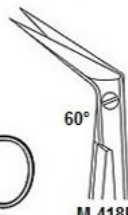

60°

**M-418PC**

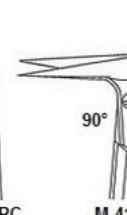

90°

**M-418PD**

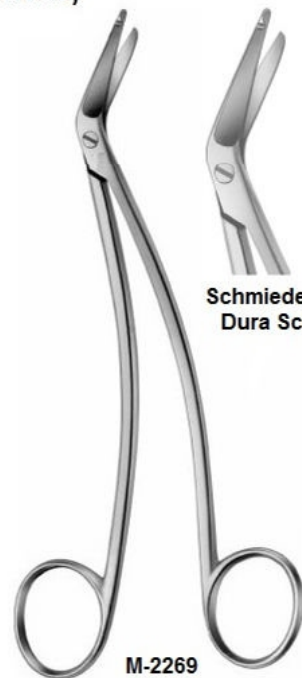

**M-2269  
(16cm)**

**Schmeden-Tailor  
Dura Scissors**

## MICRO FORCEPS

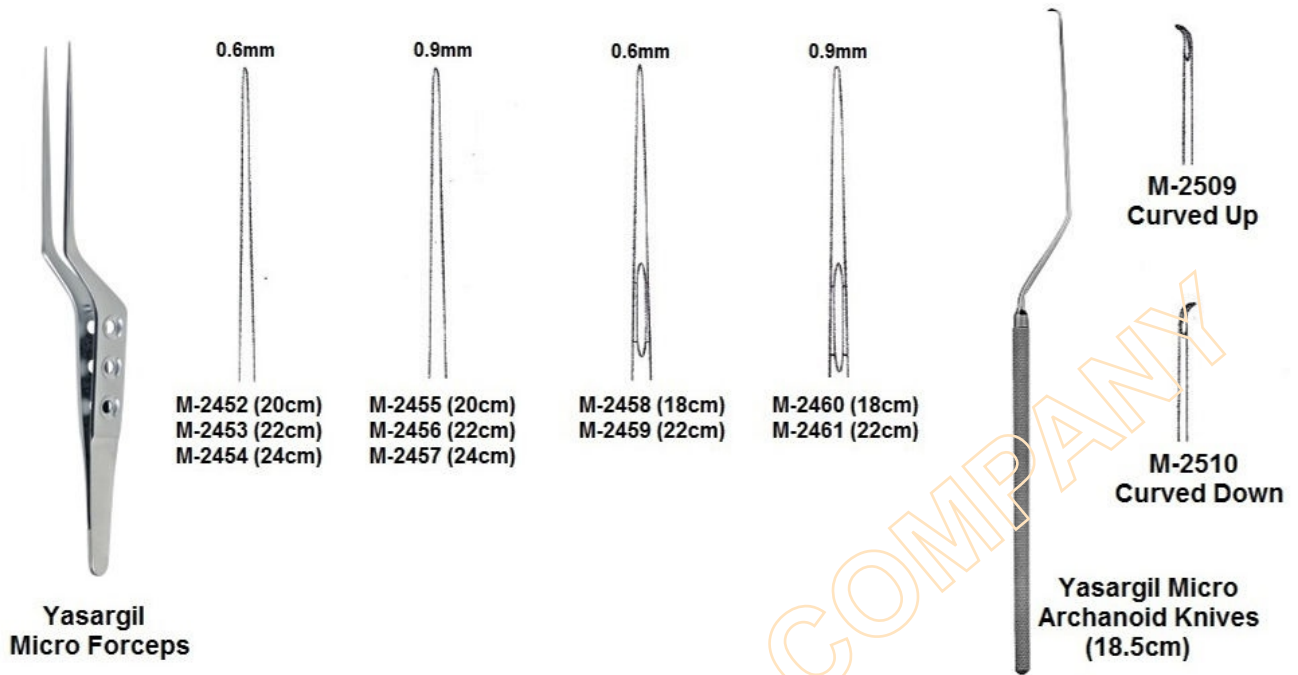



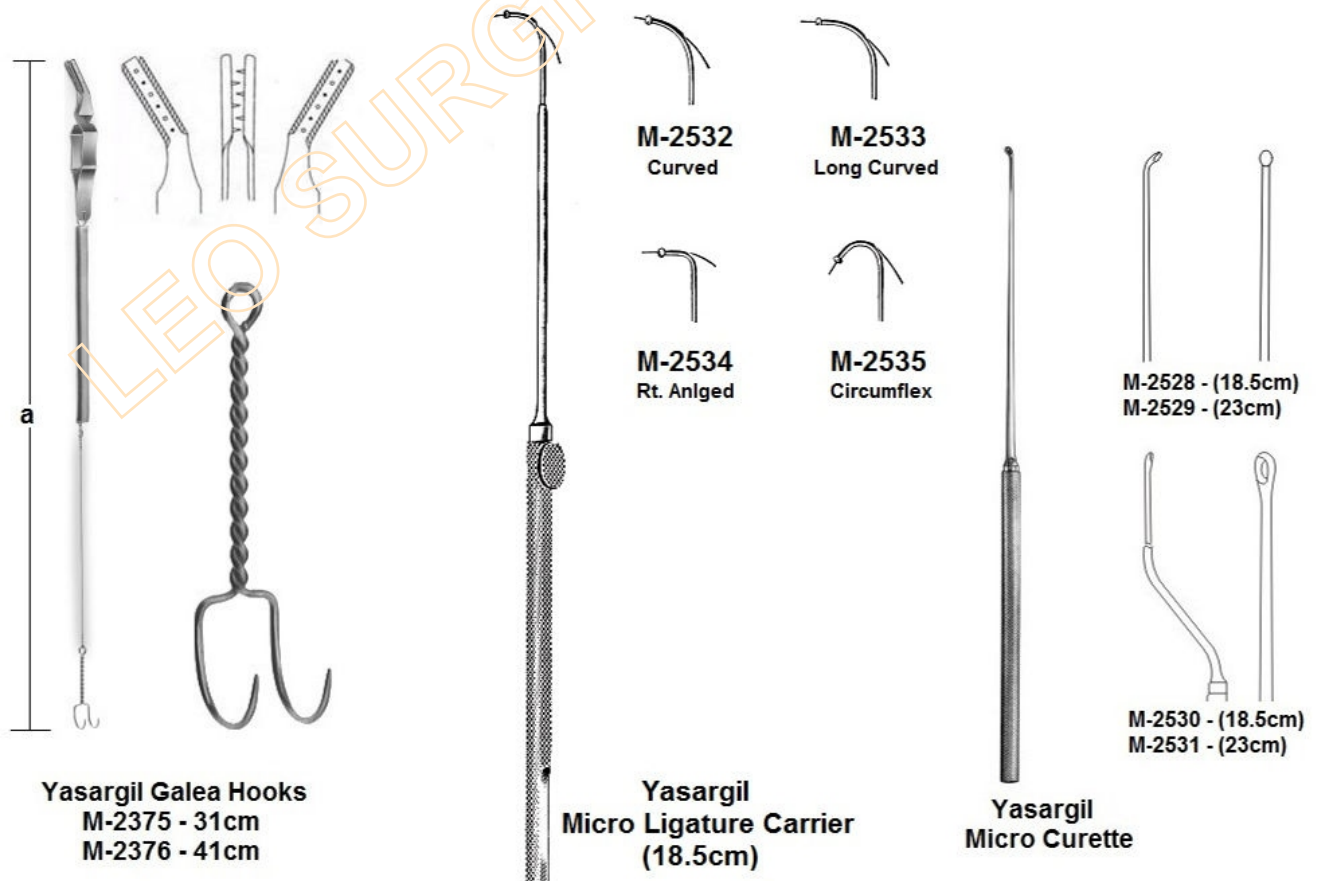



## MICRO NEURO INSTRUMENTS



## TUMOR GRASPING FORCEPS

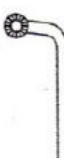







**Yasargil Tumor Grasping Forceps**

	Spoon Shaped	Heavily Serrated	Delicate Serrated	Right Angled
$\Phi 3\text{mm}$	 M-2462 (22cm) M-2463 (24cm)	 M-2466 (16cm) M-2467 (20cm) M-2468 (22cm) M-2469 (24cm)	 M-2474 (20cm) M-2475 (22cm) M-2476 (24cm)	 M-2480 (22cm)
$\Phi 5\text{mm}$	 M-2464 (22cm) M-2465 (24cm)	 M-2470 (16cm) M-2471 (20cm) M-2472 (22cm) M-2473 (24cm)	 M-2477 (20cm) M-2478 (22cm) M-2479 (24cm)	

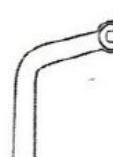

**Yasargil Tumor Grasping Forceps (23cms)**

	$\Phi 3\text{mm}$	$\Phi 4\text{mm}$	$\Phi 5\text{mm}$
<b>Curved Up</b>	 M-2481	 M-2483	 M-2485
<b>Curved Down</b>	 M-2482	 M-2484	 M-2486



# TUMOR FORCEPS, FORKS & KNIVES

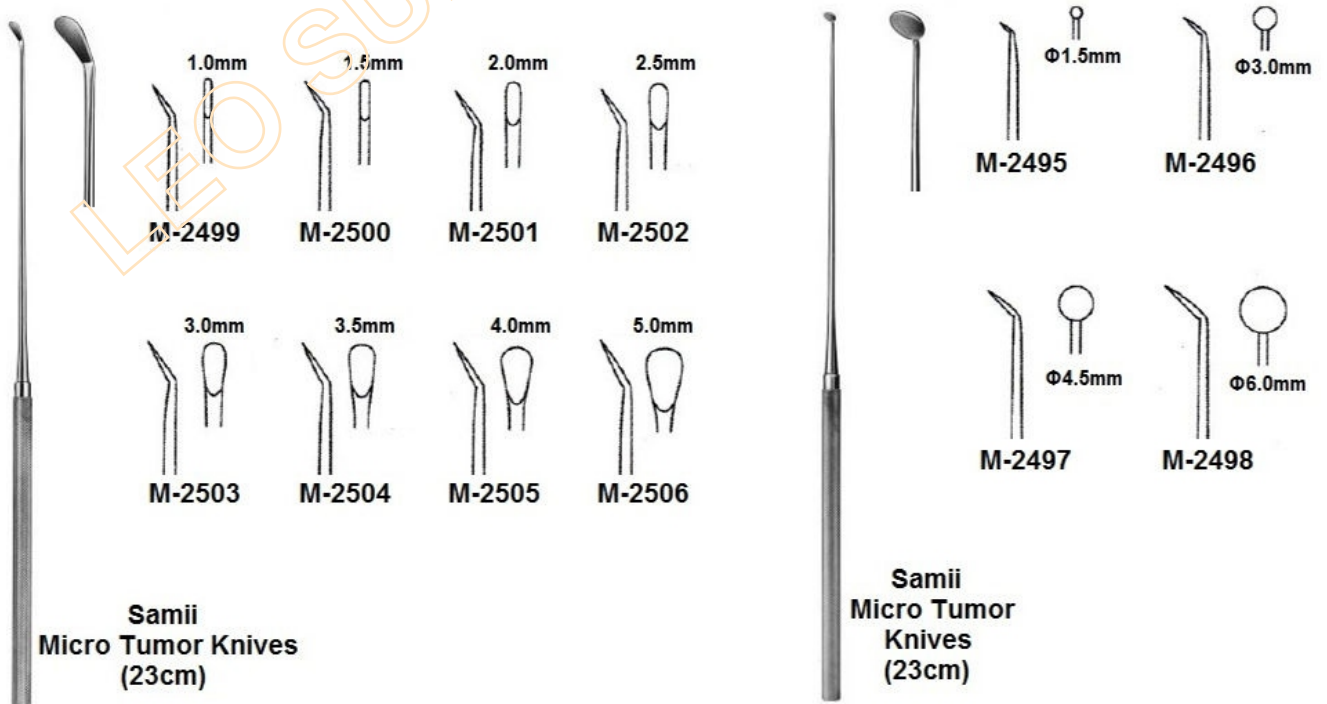
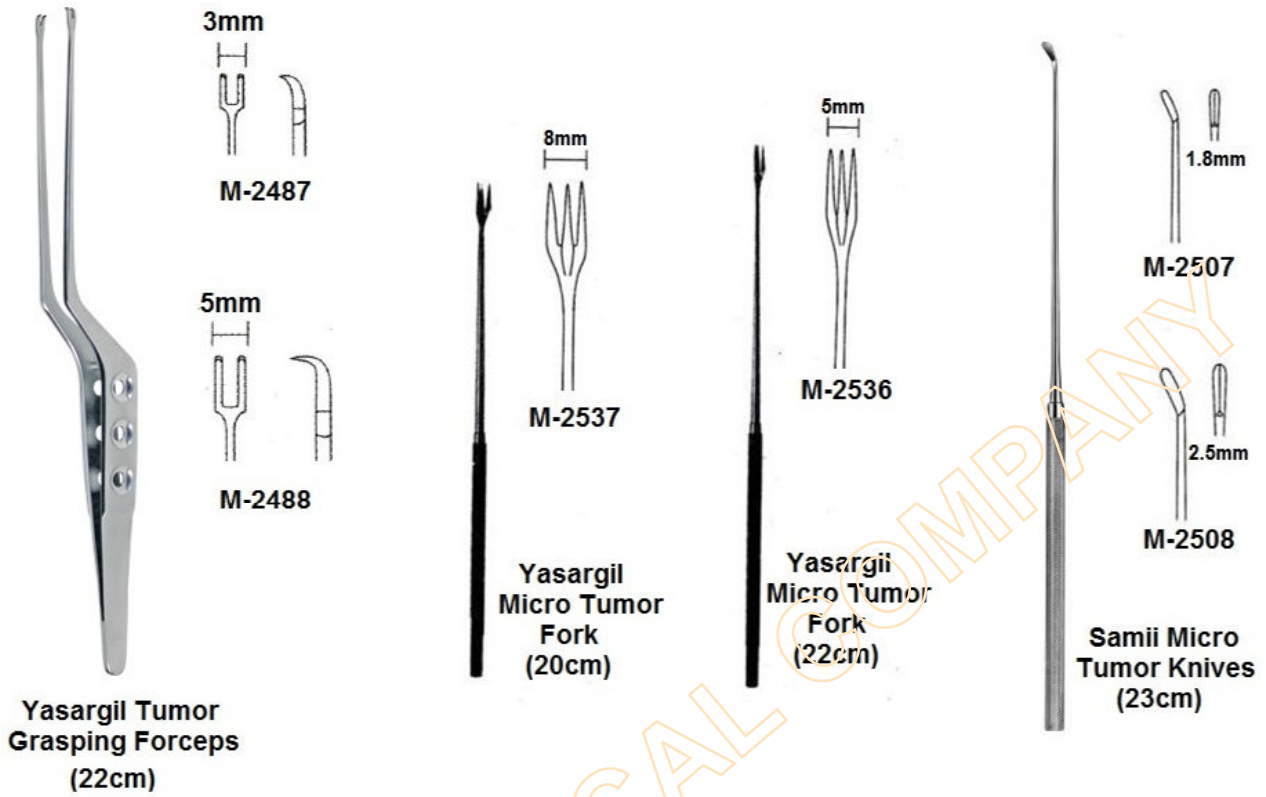

# MICRO NEEDLE HOLDERS, RASPATORIES



**Yasargil Micro  
Needle Holders**

Without Lock		With Lock	
Straight	Curved	Straight	Curved
M-2428 (16.5cm)	M-2433 (16.5cm)	M-2438 (16.5cm)	M-2443 (16.5cm)
M-2429 (18.5cm)	M-2434 (18.5cm)	M-2439 (18.5cm)	M-2444 (18.5cm)
M-2430 (20.5cm)	M-2435 (20.5cm)	M-2440 (20.5cm)	M-2445 (20.5cm)
M-2431 (22.5cm)	M-2436 (22.5cm)	M-2441 (22.5cm)	M-2446 (22.5cm)
M-2432 (24.5cm)	M-2437 (24.5cm)	M-2442 (24.5cm)	M-2447 (24.5cm)

Without Lock Extremely Fine		With Lock Extremely Fine	
Straight	Curved	Straight	Curved
M-2448 (22.5cm)	M-2449 (22.5cm)	M-2450 (22.5cm)	M-2451 (22.5cm)



**Yasargil  
Micro  
Raspatories  
(18.5cm)**

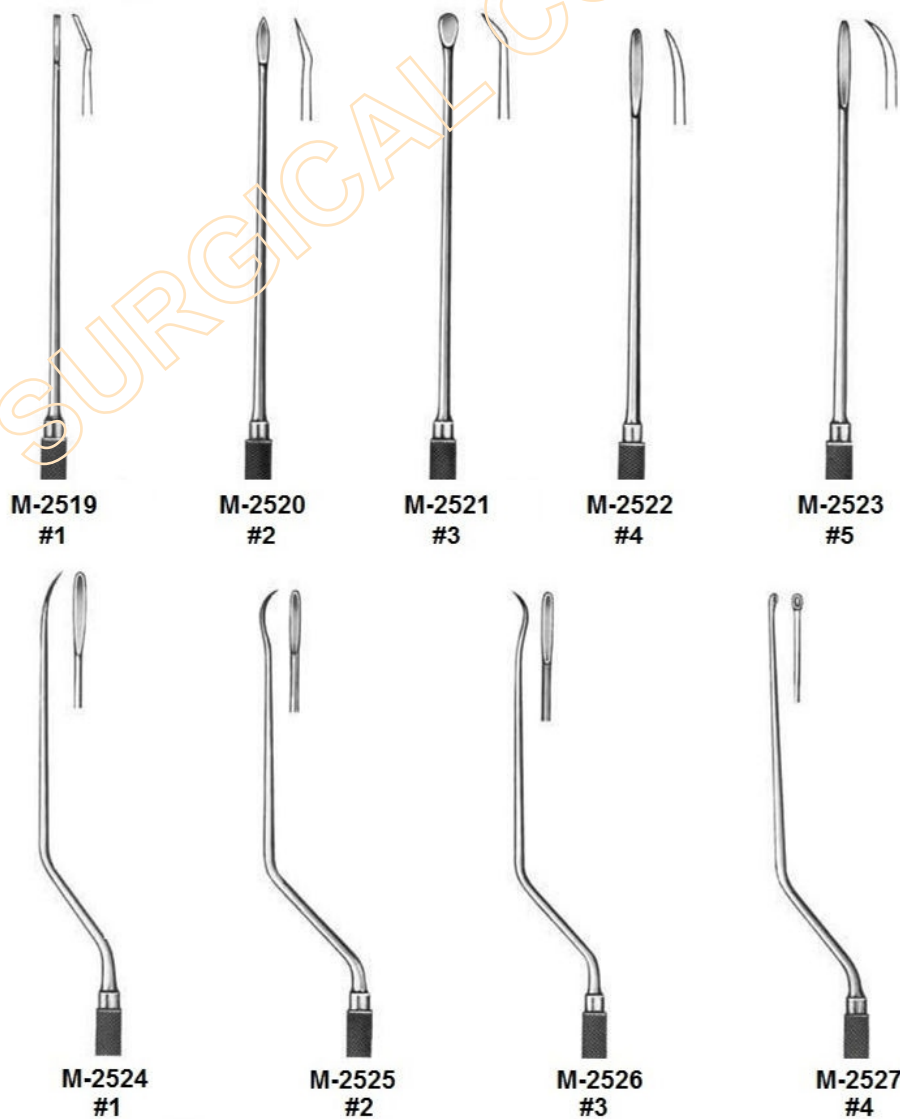

## MICRO SCISSORS

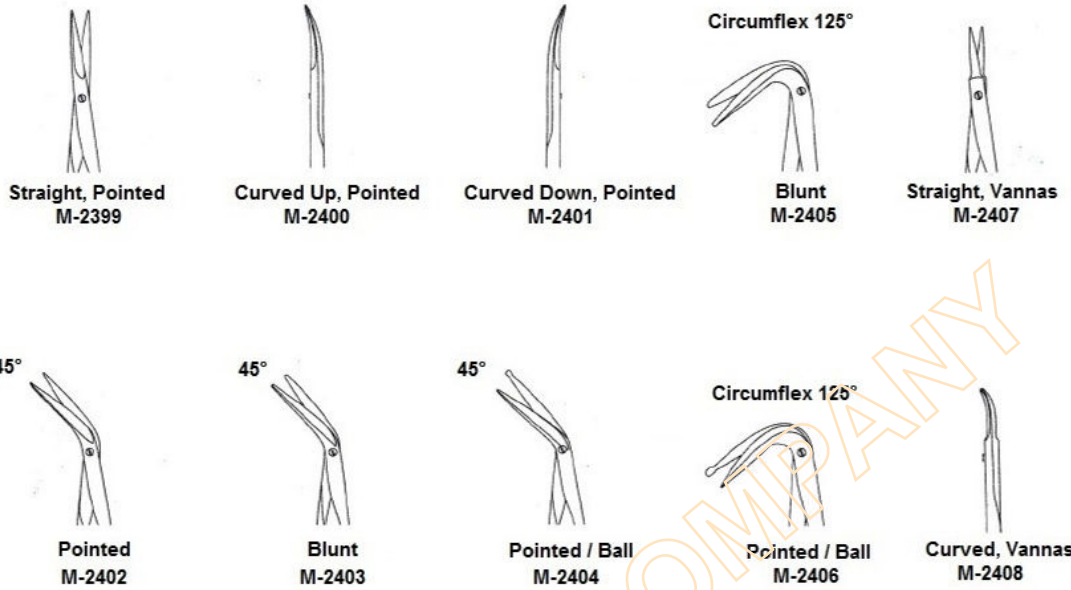

**Yasargil  
Micro Scissors  
(18.5cm)**



**Yasargil  
Micro Scissors**

## VESSEL KNIVES

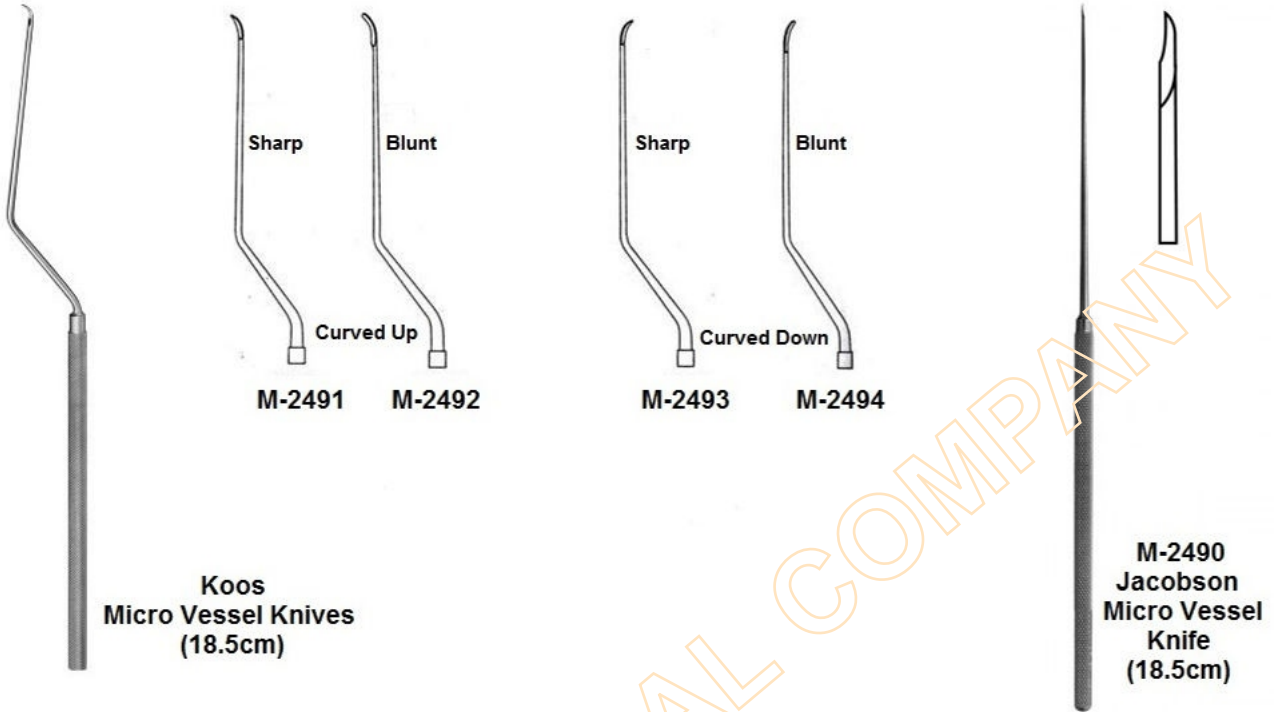

## VESSEL PROBES

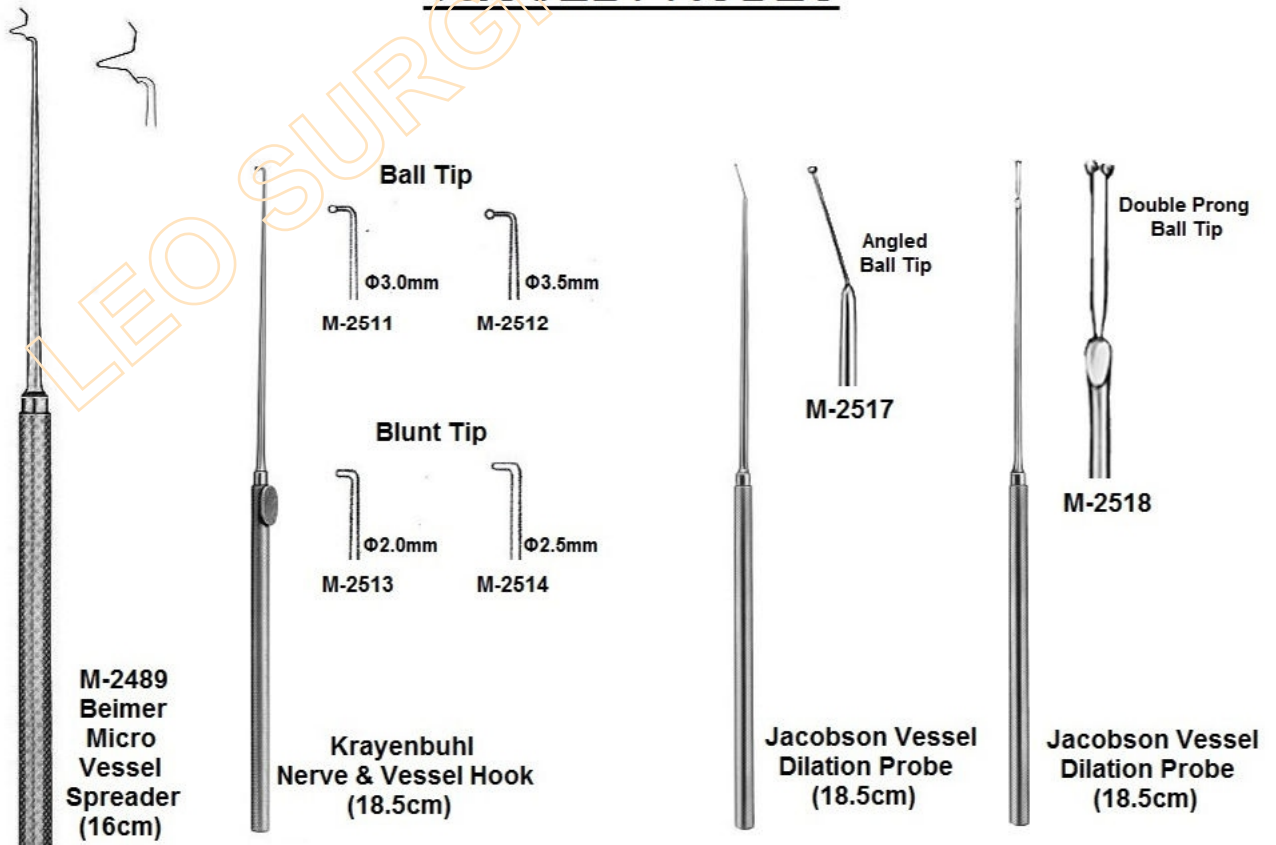

## MICRO DISSECTOR SET

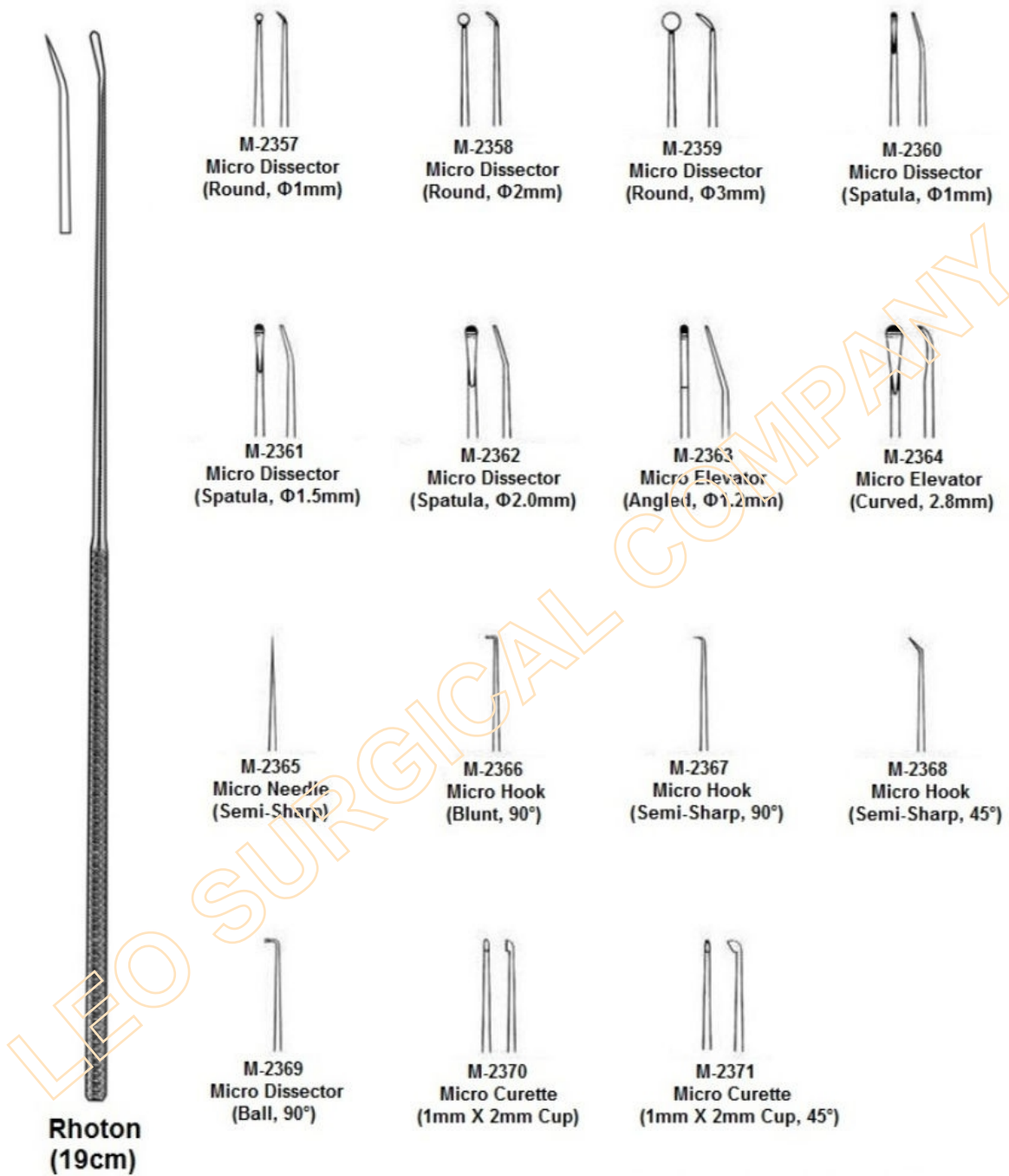

**M-2372**  
FusionKraft™ Rhoton Micro Dissector Set,  
Complete including one each of M-2357 to  
M-2371 in Metal Case



# DISSECTORS



**#1**  
**(18cm)**  
**M-2262**



**#2**  
**(19.5cm)**  
**M-2263**



**#3**  
**(19.5cm)**  
**M-2264**



**#4**  
**(21cms)**  
**M-2265**

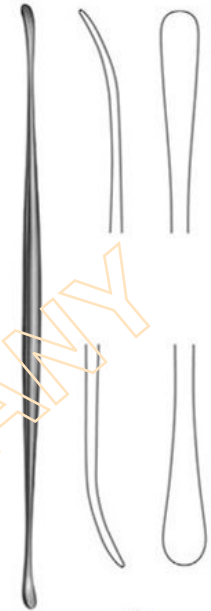

**#5**  
**(29cm)**  
**M-2266**

## Penfield Dissector Set (Set of 5)

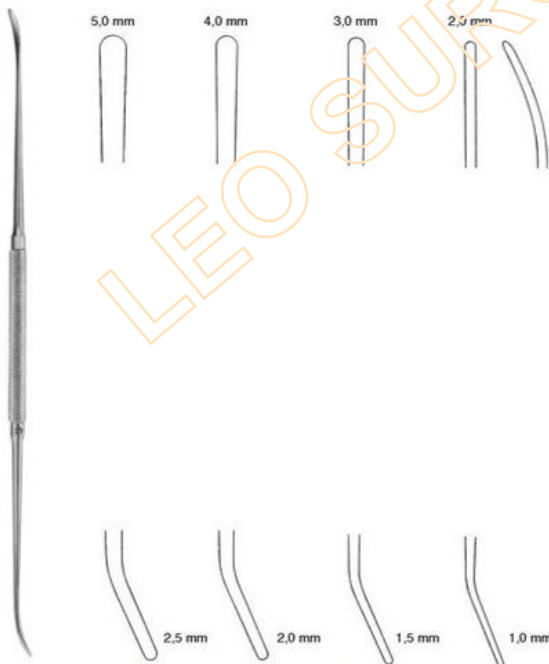

**M-2295 M-2296 M-2297 M-2298**

**Robb Vascular  
Dissector  
(24cm)**

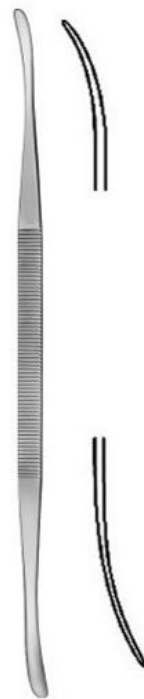

**Toennis Dura  
Dissector  
(24cm)**

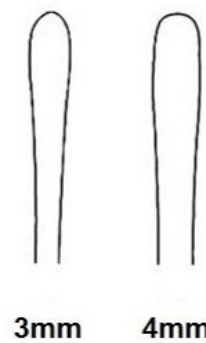

**3mm 4mm**  
**M-2292 (Small) M-2293 (Large)**



**Davis Dissector  
M-2299  
(24.5cm)**

## DISSECTORS

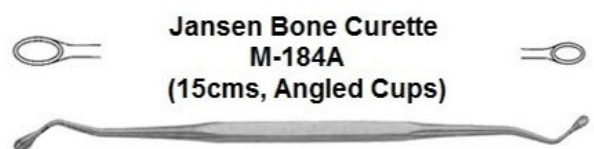
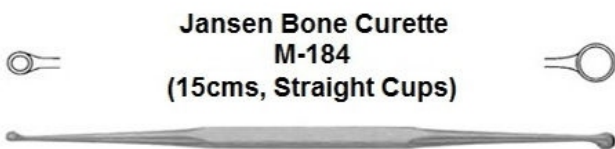
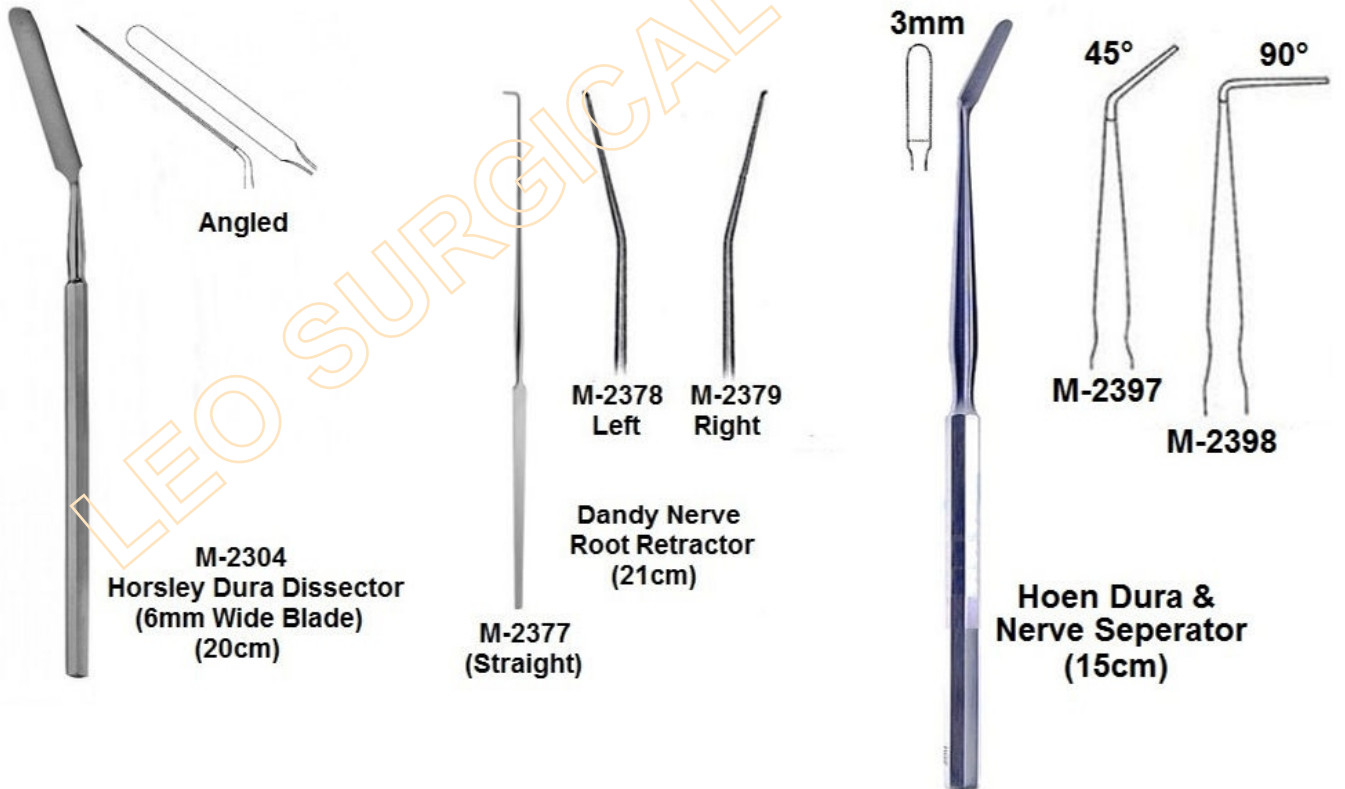
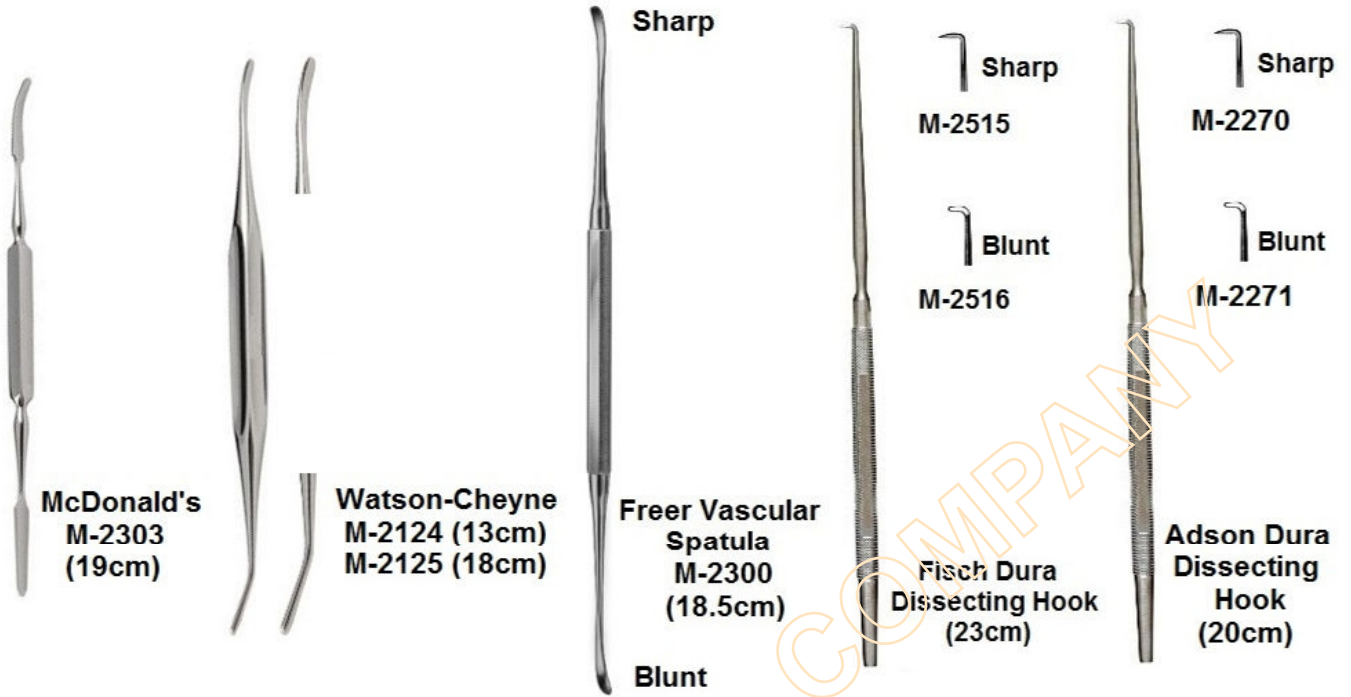

## ROOT RETRACTORS & HOOKS

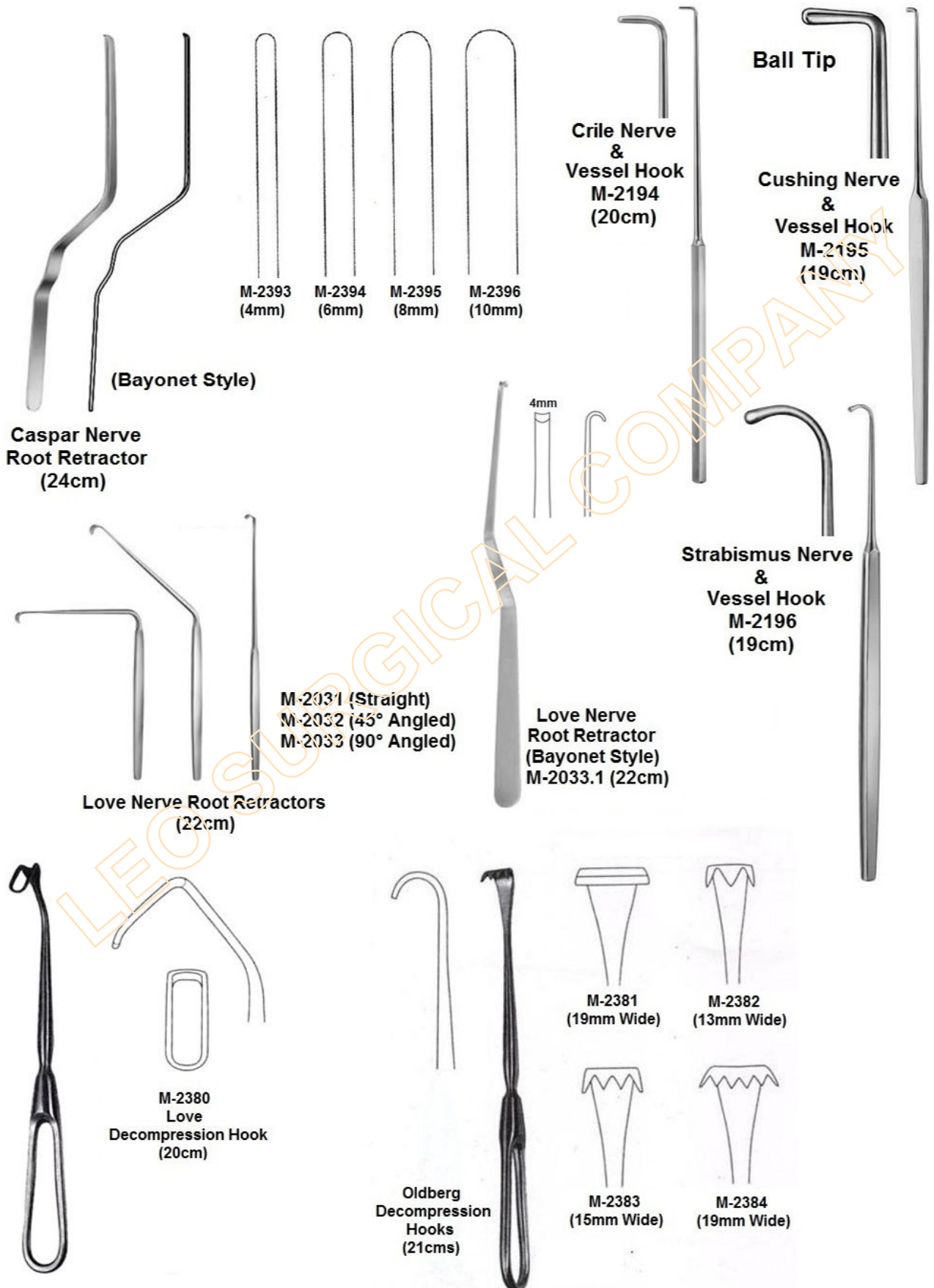



## HUDSON BRACE SET



**Hudson Brace with Thumbscrew Chuck  
M-4430 (27cms)**



**Hudson Brace with Snaplock Chuck  
M-4430 (28cms)**

### Hudson Burrs

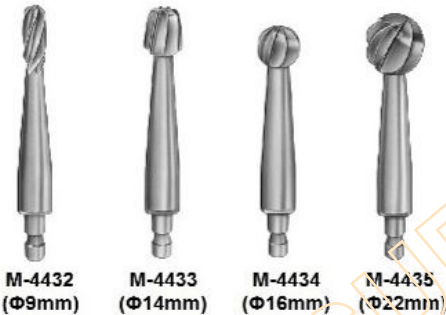

M-4432 (Φ9mm)    M-4433 (Φ14mm)    M-4434 (Φ16mm)    M-4435 (Φ22mm)



**Scoville Circular Trepphine  
(For Hudson Brace)**

M-4508	-	Φ35mm
M-4509	-	Φ40mm
M-4510	-	Φ45mm
M-4511	-	Φ50mm

### Miscellaneous Attachments to Hudson Braces



- A. Cushing Perforator Drill**  
M-4438 (Φ10mm)  
M-4439 (Φ13mm)  
M-4440 (Φ16mm)  
M-4441 (Φ18mm)  
M-4442 (Φ20mm)  
M-4443 (Φ24mm)

- B. Cushing Perforator Burr**  
M-4444 (Φ10mm)  
M-4445 (Φ16mm)  
M-4446 (Φ20mm)

- C. McKenzie Perforating Drill**  
M-4447 (Φ13mm)

- D. McKenzie Enlarging Burr**  
M-4448 (Φ17mm)

- E. D'errico Perforating & Enlarging Burr**  
M-4449 (Φ16mm)

- F. Hudson Cerebellar Extension**  
M-4450 (10cm)

### **Set Ordering Info**

- M-4436 - FusionKraft™ Hudson Brace Set with Standard Thumbscrew Chuck, Complete with 4 Burrs : One Each of M-4432 to M-4435  
M-4437 - FusionKraft™ Hudson Brace Set with Snaplock Chuck, Complete with 4 Burrs : One Each of M-4432 to M-4435

# HAND DRILLS

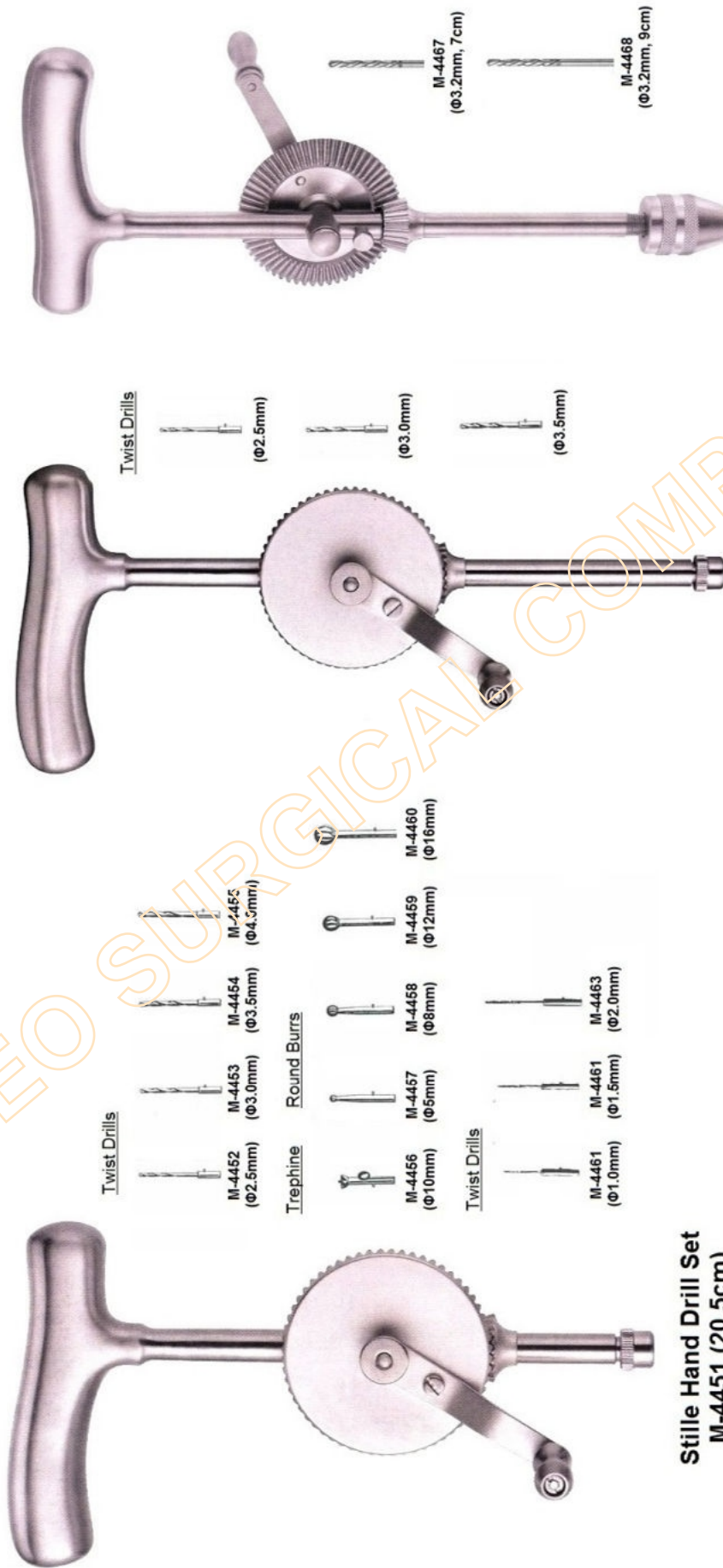

**Stille Hand Drill Set**  
M-4451 (20.5cm)

M-4464 - FusionKraft™ Stille Hand Drill Set, Complete with set of 7 Twist Drills, 4 Round Burrs & Trepine (M-4452 to M-4463)

**Stille-Sherman Drill Set**  
M-4465 (25cm)  
(Complete with 3 Twist Drills)

**Moore Hand Drill**  
M-4466 (28cm)  
(Complete with Jacobs Chuck & Key)  
M-4469 - FusionKraft™ Moore Hand Drill Set, Complete with M-4468 & M-4469



**Martin Hand Drill Set  
M-4471  
(Complete with Chuck & Wrench)  
(For Shanks Upto 6.35mm)**



**Ralk Hand Drill Set**  
**M-4473**  
(Complete with Chuck & Key)



**Tap Handle Drill Set**  
**M-4475**  
(Complete with Chuck & Key)



**Twist Drill Bits**  
(Fits Jacobs Chuck)

	Diameter(Φ)	Total Length	Flute Length
M-4477	1.0mm	55mm	25mm
M-4478	1.5mm	70mm	30mm
M-4479	2.0mm	85mm	38mm
M-4480	2.5mm	95mm	43mm
M-4481	2.7mm	85mm	32mm
M-4482	3.2mm	106mm	48mm
M-4483	3.5mm	112mm	52mm
M-4484	4.0mm	127mm	45mm
M-4485	4.5mm	127mm	51mm
M-4486	4.7mm	127mm	53mm
M-4487	5.0mm	127mm	57mm

**Extra Long Bits**

M-4488	3.2mm	180mm	70mm
M-4489	3.5mm	180mm	70mm
M-4490	4.5mm	180mm	70mm
M-4491	6.0mm	180mm	70mm

## TRACTION TONGS

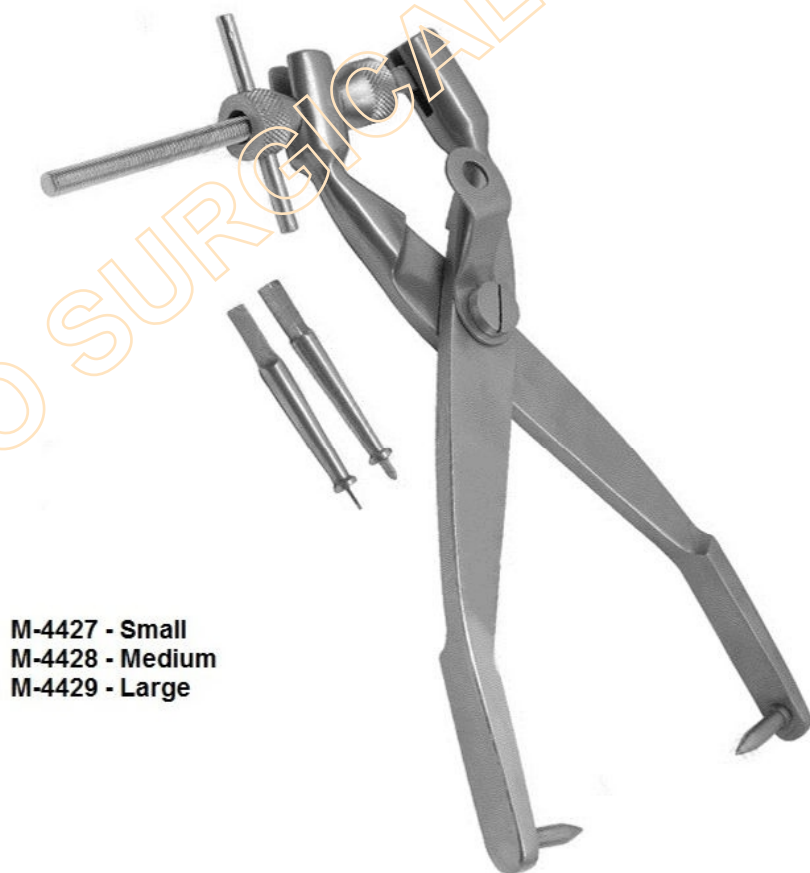

**Crutchfield Traction Tongs Set  
(Complete Incl. 2 Burrs)**

## SKULL INSTRUMENTS



**M-2374**  
**Cone Cranial Punch**  
(21cm)



**M-2373**  
**De Vilbiss**  
**Skull Channelling Forceps**  
(21cms)



**Φ27cm**  
**M-3682**  
**Hajek Mallet**  
(225gms)



**Gigi Saw Handle**  
**M-2068**



**M-1725**  
**Olivercrona-Toennis**  
**(Scoville)**  
(14cm)



**M-2209**  
**De-Martel Conductor**  
**(For Gigi & Oliverconca)**



**McKenzie**  
**M-1726 (15cm)**  
**M-1727 (19cm)**



**McKenzie**  
**M-1728 (15cm)**  
**M-1729 (19cm)**



**Raney**  
**M-1730**  
(16cm)

## LAMINA SPREADERS

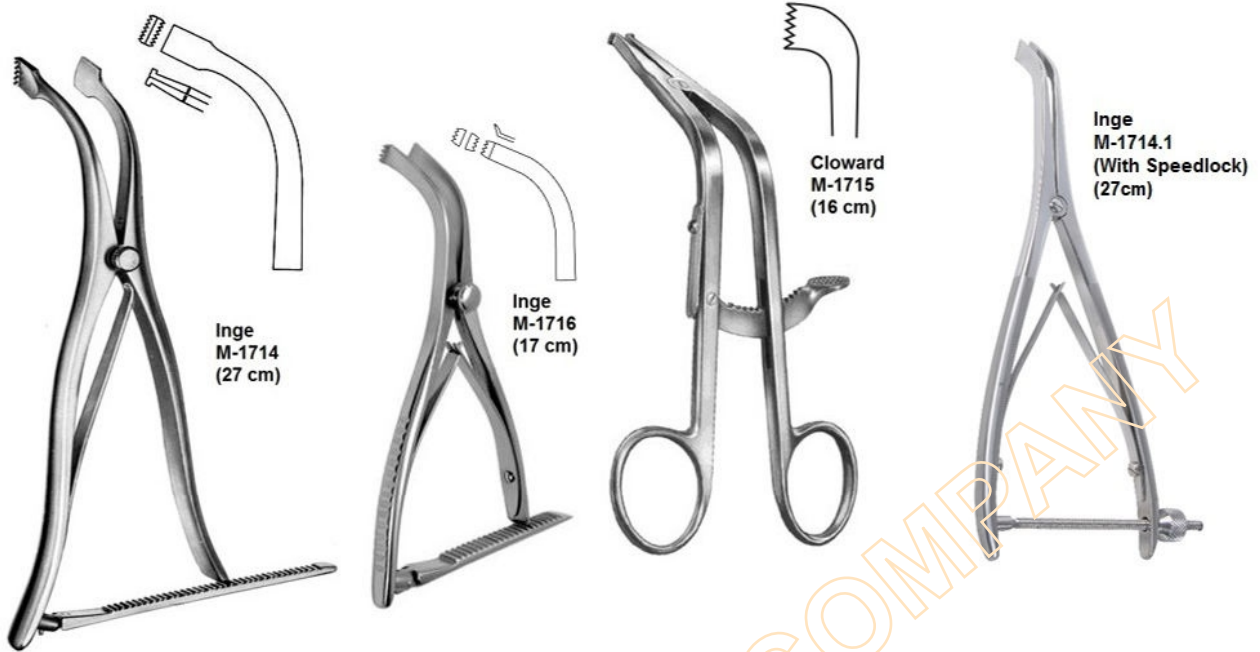

## PUNCHES & RONGEURS

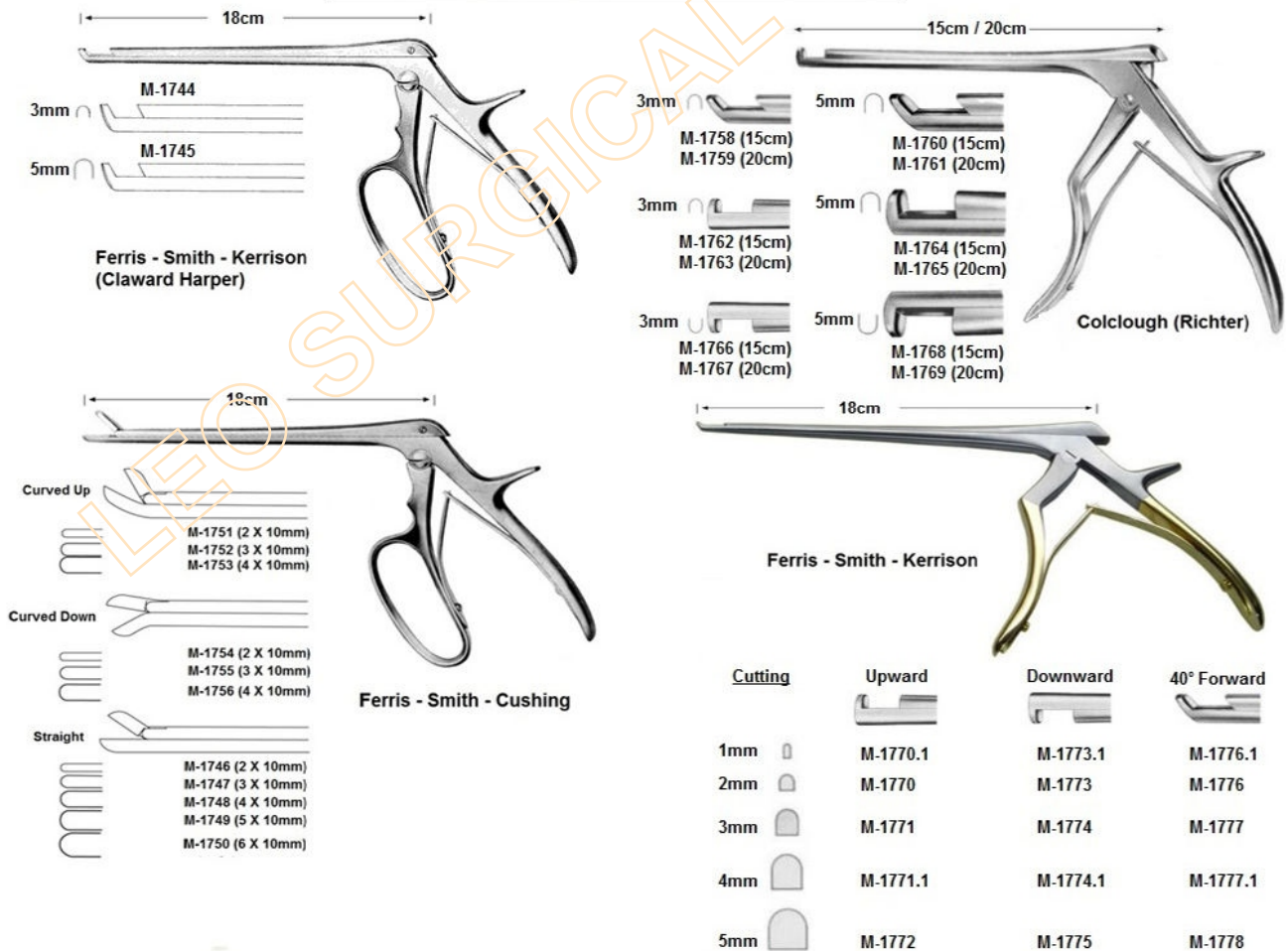

## RONGEURS

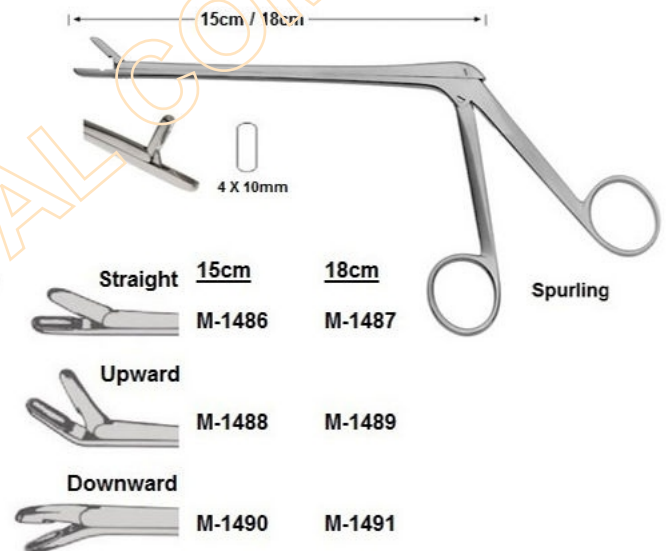
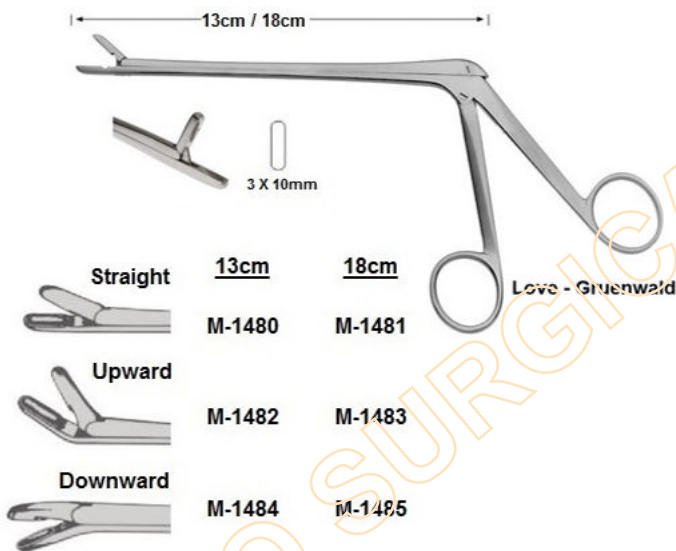
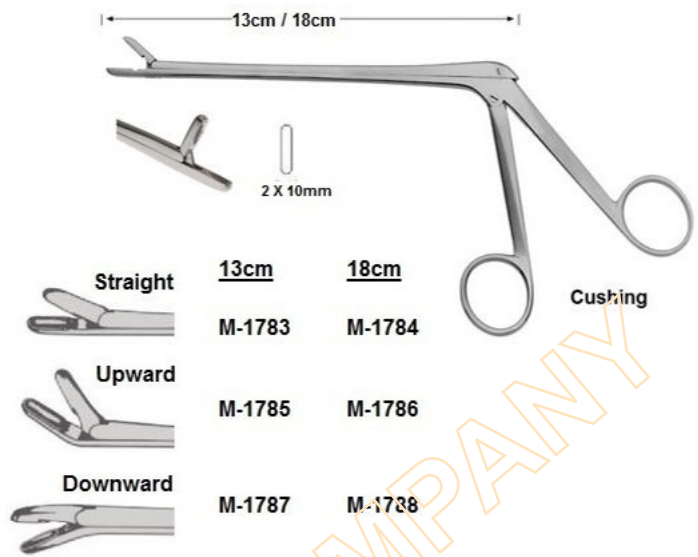
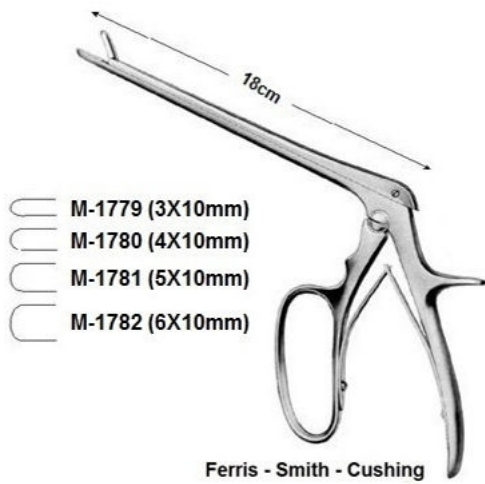

## PUNCHES

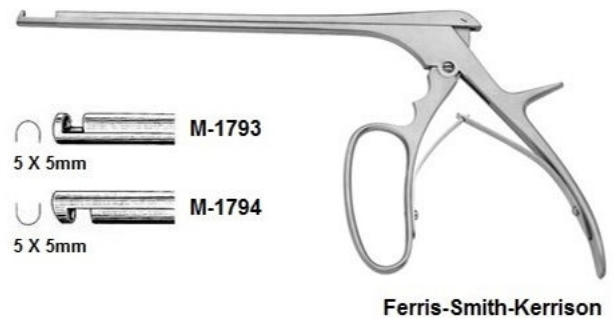
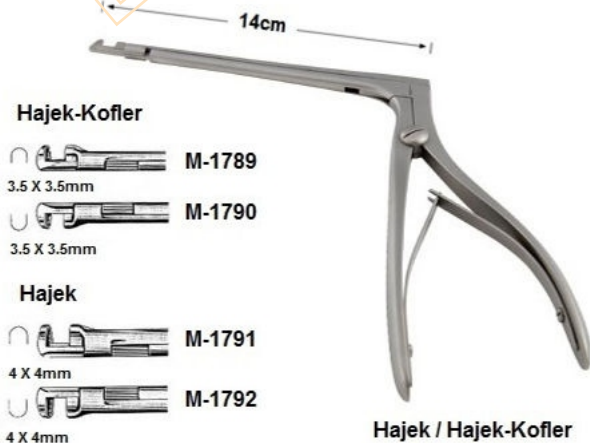



# RETRACTORS



**Gelpi - Loktite**  
M-1328 (13 cm)



**Gelpi - Sieletz**  
M-1329 (15 cm)



**Weitlaner - Wullstein**

**Sharp** (3X3 Prongs)  
M-1341 (13.0cm)  
M-1341.1 (10.5cm)  
M-1341.2 (16.5cm)  
(4X4 Prongs)  
M-1341.3 (20.5cm)

**Blunt** (3X3 Prongs)  
M-1342 (13.0cm)  
M-1342.1 (10.5cm)  
M-1342.2 (16.5cm)  
(4X4 Prongs)  
M-1342.3 (20.5cm)



**Sharp**  
Mollison  
M-1343  
(15 cm)



**Gelpi - Loktite**  
M-1330 (18 cm)



**Gelpi - Loktite**  
M-1331 (18 cm)



**Adson**  
M-1344 to M-1347  
(26.5 cm)

(4X4 Prongs)  
**Sharp**

M-1344

(4X4 Prongs)  
**Blunt**

M-1345

(6X6 Prongs)  
**Sharp**

M-1346

(6X6 Prongs)  
**Blunt**

M-1347



**Norfolk - Norwich Retractor**  
(4X5 Blunt Prongs)  
M-2285 (23cms)  
M-2286 (28cms)

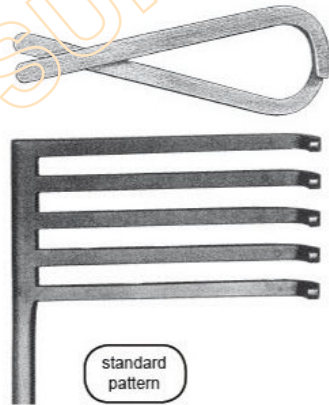

**Miskimon Cerebellar Retractor**  
M-2260 (Sharp, 20cms)  
M-2261 (Blunt, 20cms)

\* Also known as N&N Retractor

## RETRACTORS



**Williams Micro-Lumbar  
Dissectomy Retractor  
(16.5cm)**

Blade Side	Blade Width	Blade Length	Article No.
Right	1 cm	5 cm	M-4418
	1 cm	7 cm	M-4419
	2 cm	5 cm	M-4420
	2 cm	7 cm	M-4421
Left	1 cm	5 cm	M-4422
	1 cm	7 cm	M-4423
	2 cm	5 cm	M-4424
	2 cm	7 cm	M-4425



**Beckmann - Adson Retractor  
(4X4 Prongs, Hinged, 31cms)  
M-4356 (Sharp)  
M-4357 (Blunt)**

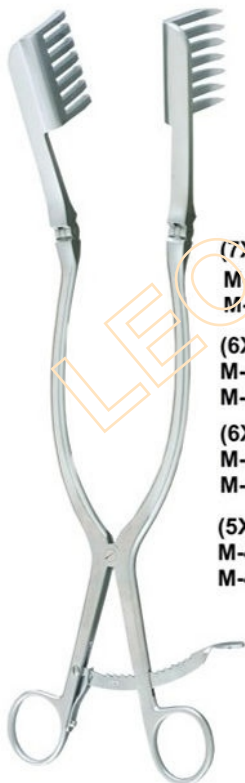

- (7X7 Prongs, Hinged, 32.5cms)  
M-4358 (Sharp)  
M-4359 (Blunt)
- (6X6 Prongs, Hinged, 28.5cms)  
M-4360 (Sharp)  
M-4361 (Blunt)
- (6X6 Prongs, Hinged, 25cms)  
M-4362 (Sharp)  
M-4363 (Blunt)
- (5X5 Prongs, Hinged, 20.5cms)  
M-4364 (Sharp)  
M-4365 (Blunt)

**Beckmann-Eaton Retractor**

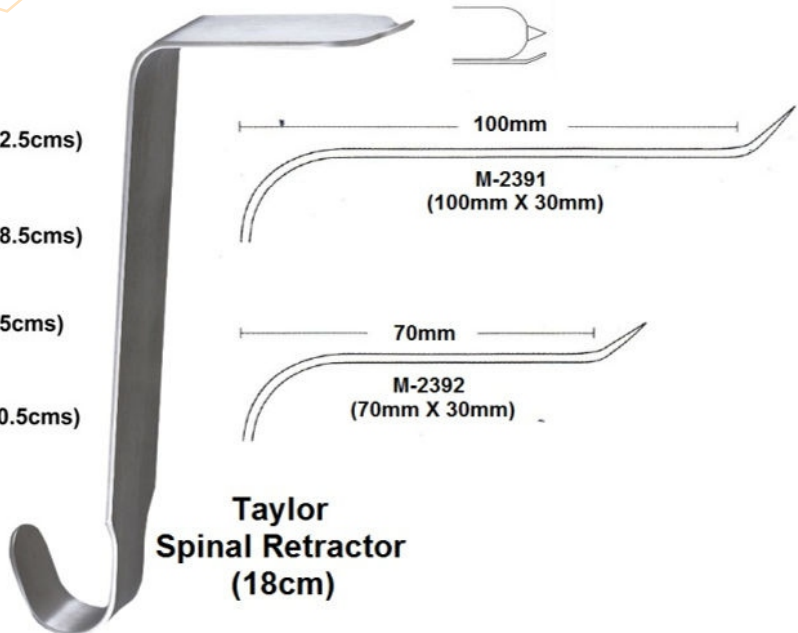

**Taylor  
Spinal Retractor  
(18cm)**

## CERVICAL RETRACTORS



**Caspar Cervical Vertebral Retractor  
M-4377  
(85mm Maximum Spread, 16.5cms)**



**Caspar Cervical Vertebral Columnar Retractor  
M-4379  
(Adjustable, Hinged)**



**Caspar Cervical Vertebral Retractor  
M-4378  
(125mm Maximum Spread, 20cms)**

## BLADES



Size 1 40 X 23mm  
Size 2 45 X 23mm  
Size 3 50 X 23mm  
Size 4 55 X 23mm  
Size 5 60 X 23mm

**Medial Blades  
(Set of 5)**

**M-4379MB**



Size 1 40 X 23mm  
Size 2 45 X 23mm  
Size 3 50 X 23mm  
Size 4 55 X 23mm  
Size 5 60 X 23mm

**Lateral Blades  
(Set of 5)**

**M-4379LB**



Size 1 40 X 23mm  
Size 2 45 X 23mm  
Size 3 50 X 23mm  
Size 4 55 X 23mm  
Size 5 60 X 23mm

**Blunt Blades  
(Set of 5)**

**M-4379BB**



Size 1 50 X 25mm  
Size 2 60 X 25mm

**Blunt Blades  
(Set of 2)**

For harvesting of fusion graft  
from the iliac crest

**M-4379GB**

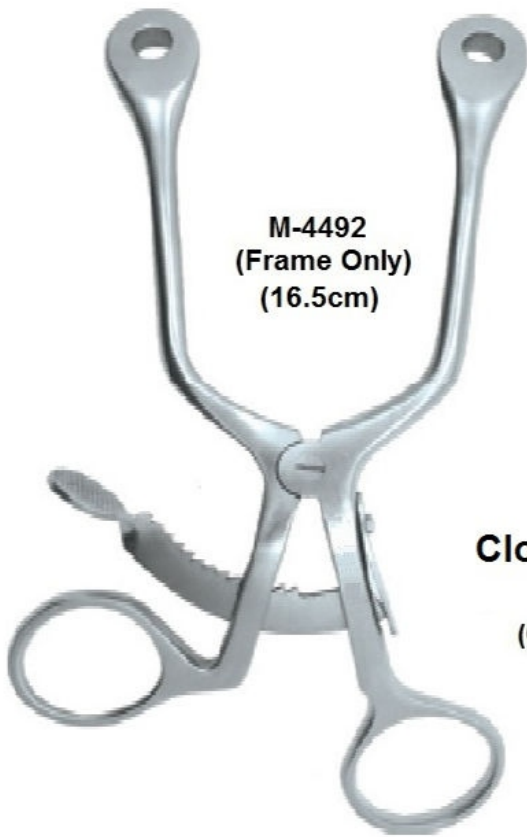

**Blunt Blades**

- set of 5 Blades
- 40mm X 15/23mm
- 45mm X 15/23mm
- 50mm X 15/23mm
- 55mm X 15/23mm
- 60mm X 15/23mm

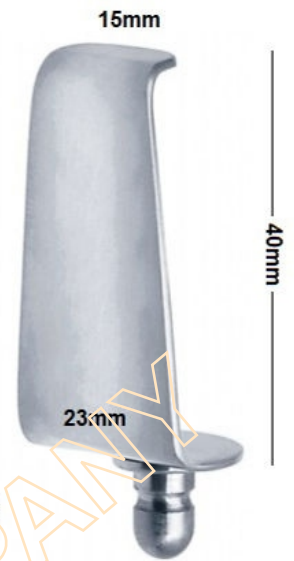

**Cloward Cervical Retractor Set**

M-4493  
(Complete Set with 5 Blunt Blades)



**Toothed Blades**

- Set of 5 toothed Blades includes :
- 40mm X 15/23mm
  - 45mm X 15/23mm
  - 50mm X 15/23mm
  - 55mm X 15/23mm
  - 60mm X 15/23mm

**Cloward Cervical Retractor Set**

M-4496  
(Complete with 5 Toothed Blades)

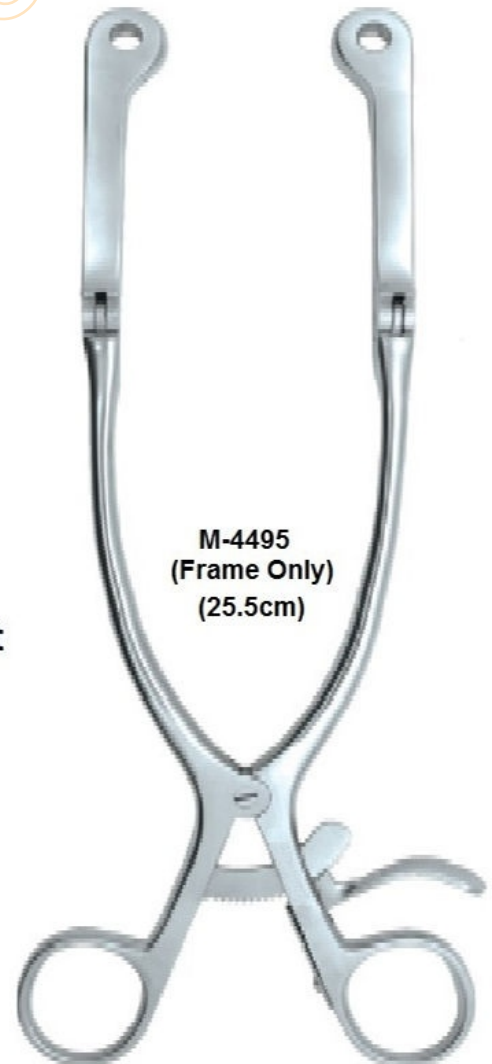

## CASPAR VERTEBRAL DISTRACTORS

**M-2273**  
Caspar Distractor  
Multiple Level, Left



**M-2274**  
Caspar Distractor  
Multiple Level, Right



**M-2275**  
Caspar Type Drill Guide  
(Phenolic Handle, Left)



**M-2276**  
Caspar Type Drill Guide  
(Phenolic Handle, Right)



**M-2277**  
Caspar Type Screw Driver  
(Phenolic Handle, 20cm)



**M-2278**  
Caspar Type Twist Drill  
(14.5cm)



**Caspar Type Distraction Screws**

<b>M-2279</b>	-	<b>12mm</b>
<b>M-2280</b>	-	<b>14mm</b>
<b>M-2281</b>	-	<b>16mm</b>
<b>M-2282</b>	-	<b>18mm</b>



### **Set Ordering Info**

- M-2283** - FusionKraft™ Caspar Vertebral Distractor Set, Left consisting of : M-2273, M-2275, M-2277, M-2278 & M-2281 (X2)
- M-2284** - FusionKraft™ Caspar Vertebral Distractor Set, Right consisting of : M-2274, M-2276, M-2277, M-2278 & M-2281 (X2)

## LUMBAR SPINE RETRACTOR FOR MICRO DISSECTOMY



**McColloch Lumbar Spine  
Retractor for Micro Dissectomy  
(With 4 Blades & 2 Hooks)**



**Wide Muscle Blade  
(6 Teeth)**

M-4392 (27X30mm)  
M-4393 (27X40mm)  
M-4394 (27X50mm)  
M-4395 (27X60mm)  
M-4396 (27X70mm)  
M-4397 (27X80mm)



**Narrow Muscle Blade  
(4 Teeth)**

M-4400 (20X30mm)  
M-4401 (20X40mm)  
M-4402 (20X50mm)  
M-4403 (20X60mm)  
M-4404 (20X70mm)  
M-4405 (20X80mm)



**Tooth Hook**

M-4404 (20mm)  
M-4405 (30mm)  
M-4406 (40mm)  
M-4407 (50mm)  
M-4408 (60mm)  
M-4409 (70mm)  
M-4410 (80mm)



**Hook**

M-4411 (20mm)  
M-4412 (30mm)  
M-4413 (40mm)  
M-4414 (50mm)  
M-4415 (60mm)  
M-4416 (70mm)  
M-4417 (80mm)

### **Set Ordering Info**

- M-4388 - Hinged Frame, 68mm Spread
- M-4389 - Rigid Frame, 68mm Spread
- M-4390 - Hinged Frame, 90mm Spread
- M-4391 - Rigid Frame, 90mm Spread

## HEMI-LAMINECTOMY RETRACTORS



**Scoville  
(22cm)**



**Scoville - Haverfield  
(22cm)**



**Hook  
(Blunt)  
M-4515  
(5cm)**



**Hook  
(Sharp)  
M-4517  
(5cm)**



**Hook Blade  
(4 Prongs)**

M-4522 - 48mm X 50mm  
M-4523 - 64mm X 50mm  
M-4524 - 64mm X 64mm  
M-4525 - 80mm X 57mm



**Hook Blade  
(4 Prongs)**

M-4526 - 44mm X 38mm  
M-4527 - 67mm X 44mm



**Hook  
(Blunt)  
M-4516  
(7cm)**



**Hook  
(Sharp)  
M-4518  
(7cm)**



**Blade Serrated  
(Toothed)**

M-4519 - 60mm X 25mm  
M-4520 - 61mm X 50mm  
M-4521 - 86mm X 25mm

### **Set Ordering Info**

**M-4529 - FusionKraft™ Scoville Hemi-Laminectomy Retractor Set, Complete including M-4513 (Non-Hinged Frame) with 2 Hooks & 4 Blades**

**M-4530 - FusionKraft™ Scoville-Haverfield Hemi-Laminectomy Retractor Set, Complete including M-4514 (Hinged Frame) with 2 Hooks & 4 Blades**



(Hinged Arms)

**Harris Laminectomy Retractor**  
M-2272 (38 X 51mm Blades)

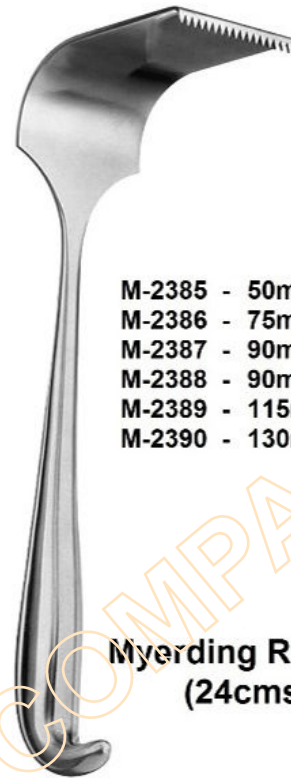

- M-2385 - 50mm X 16mm
- M-2386 - 75mm X 25mm
- M-2387 - 90mm X 50mm
- M-2388 - 90mm X 16mm
- M-2389 - 115mm X 25mm
- M-2390 - 130mm X 50mm

**Myerding Retractor**  
(24cms)

## COUNTER RETRACTOR SET WITH SPECULUMS



Black Coated

M-4539

**Caspar Counter Retractor**  
(Frame Only)



**Blades**  
(For M-4539)  
(Black Coated)

- M-4540 - 35mm
- M-4541 - 40mm
- M-4542 - 45mm
- M-4543 - 50mm
- M-4544 - 55mm
- M-4545 - 60mm
- M-4546 - 65mm
- M-4547 - 75mm
- M-4548 - 85mm



**Caspar Speculum**  
(Black Coated)

- M-4531 - 40mm
- M-4532 - 45mm
- M-4533 - 50mm
- M-4534 - 55mm
- M-4535 - 60mm
- M-4536 - 65mm
- M-4537 - 75mm
- M-4538 - 85mm

**Speculum for Counter Retractor**

### Set Ordering Info

- M-4549 - FusionKraft™ Caspar Counter Retractor, Complete Set including Frame M-4539 (X1) & set of any 5 Toothed blades



# SPINAL INSTRUMENTS



**M-4182 (Straight)**    **M-4183 (Medium Curve)**

**M-4184 (Strong Curve)**    **M-4185 (Reverse Curve)**

**Cobb (Dowson-Yuhl) Spinal Gouge (28cms)**

Width	Article No.
9mm	M-4194
13mm	M-4195
19mm	M-4196
25mm	M-4197
32mm	M-4198

**Cobb Spinal Elevator (28cms)**

**Straight**    **Angled**

Size	Straight	Angled
Ø 4 mm	M-4230	M-4233
Ø 7 mm	M-4231	M-4234
Ø 9 mm	M-4232	M-4235

**Cone Ring Curette (23cms)**

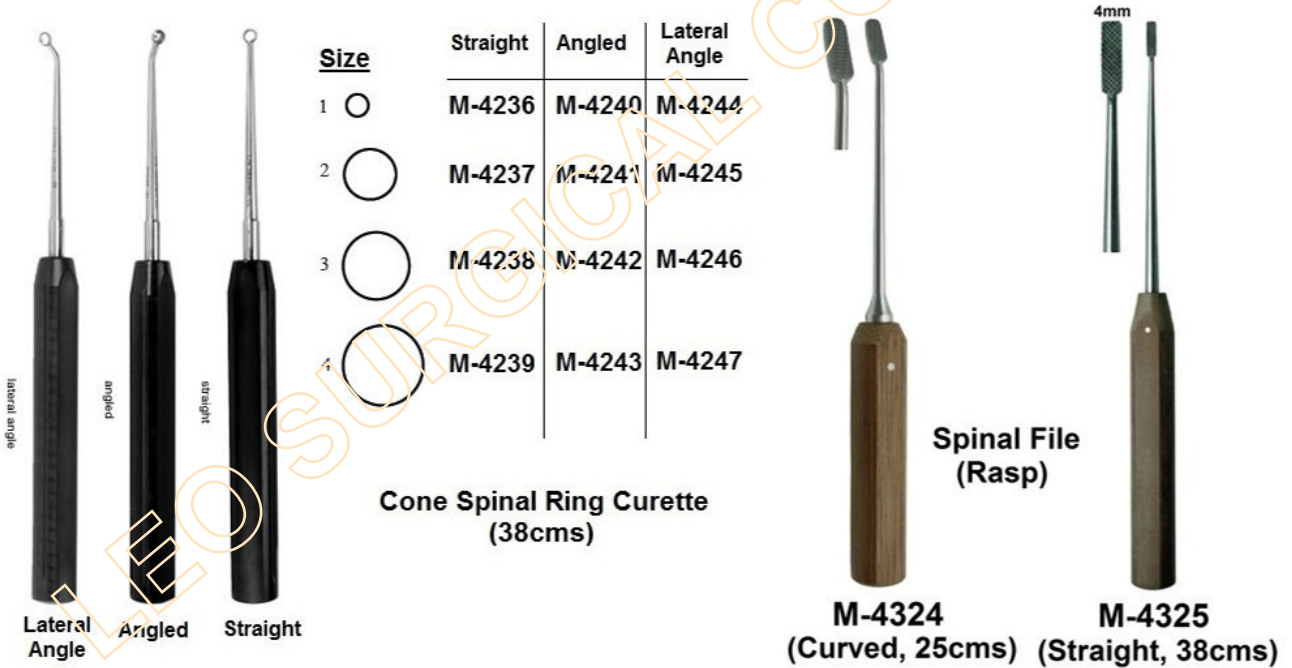

Size	Straight	Angled	Lateral Angle
1	M-4236	M-4240	M-4244
2	M-4237	M-4241	M-4245
3	M-4238	M-4242	M-4246
4	M-4239	M-4243	M-4247

**Cone Spinal Ring Curette (38cms)**

**Lateral Angle**    **Angled**    **Straight**

**M-4324 (Curved, 25cms)**    **M-4325 (Straight, 38cms)**

**Spinal File (Rasp)**



**M-4178 (6mm)**  
**M-4179 (8mm)**  
**M-4180 (11mm)**  
**M-4181 (16mm)**

**Capener Lamina Gouge (23cms) (Cranked Shaft)**



**Volkman Curette (Double Ended) (Oval/Round Cup)**

Small    Medium    Large

M-4224 (13cm)    M-4225 (16.5cm)    M-4226 (20cm)

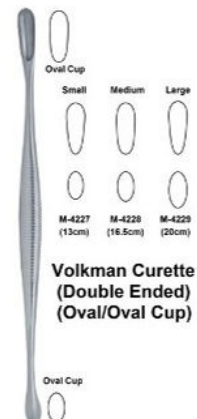

**Volkman Curette (Double Ended) (Oval/Oval Cup)**

Small    Medium    Large

M-4227 (13cm)    M-4228 (16.5cm)    M-4229 (20cm)



**M-3609**  
**(Straight)**

**M-3610**  
**(Angled)**

**M-3611**  
**(Curved)**

**Castroviejo Calipers**  
**(9cm)**  
**(Scale 0 - 20mm)**



**M-3612**  
**(Straight)**

**M-3613**  
**(Right Angled)**

**M-3614**  
**(Curved)**

**Castroviejo Calipers**  
**(17cm)**  
**(Scale 0 - 40mm)**



**M-2335**  
**Jameson Callipers**  
**(With Locking Screw)**  
**Graduated, 0 - 80mm**



**M-2336**  
**Thorpe Caliper**  
**(With Locking Screw)**  
**Graduated, 0-80mm**

**M-2120 (23cm)**  
**M-2121 (32cm)**  
**M-2122 (35cm)**  
**M-2123 (40cm)**

**M-2119 - 8mm**  
**M-2119.1 - 10mm**  
**M-2119.2 - 12mm**  
**M-2119.3 - 18mm**



**(20cm)**

**Cushing Vein Retractors**

## BONE RONGEUR FORCEPS



**Leksell - Stille**  
M-1891  
(24 cm)



**Frykholm**  
M-1892  
(24 cm)



**Stille - Leur**  
M-1893 to M-1894  
(22 cm)



**Semb**  
M-1895  
(22.5 cm)



**Stille**  
M-1896  
(23 cm)



**Stille - Ruskin**  
M-1900 (23 cm)

## BONE RONGEUR FORCEPS



**Echlin**  
M-1897 to M-1899  
(23 cm)



M-1897 M-1898 M-1899



M-1903 (23 cm)  
M-1904 (27 cm)

M-1905 (23 cm)  
M-1906 (27 cm)



**Stille - Leur**  
M-1903 to M-1906



**M-1907**



**Sauerbruch**  
(30 cm)



**M-1908**



**Sauerbruch**  
(30 cm)

## BONE CUTTING FORCEPS



**Liston - Key**  
M-1901 (27cm)  
M-1901A (22cm)



**Semb**  
M-1902  
(24cm)



**Still - Liston**  
M-1914 (27 cm)



**Still - Liston**  
M-1915 (27 cm)

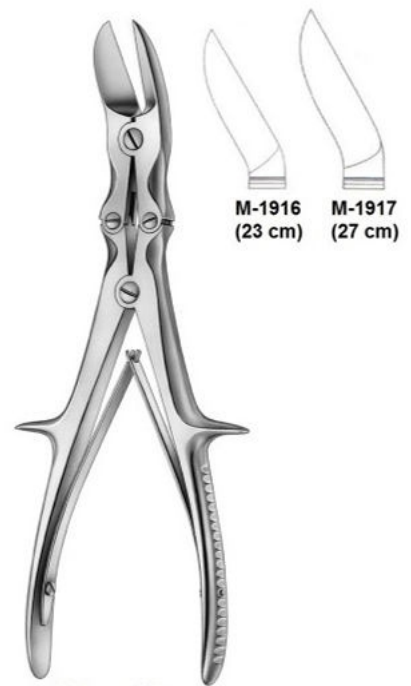

**Liston - Key**  
M-1916 to M-1917

**M-1916**  
(23 cm)    **M-1917**  
(27 cm)

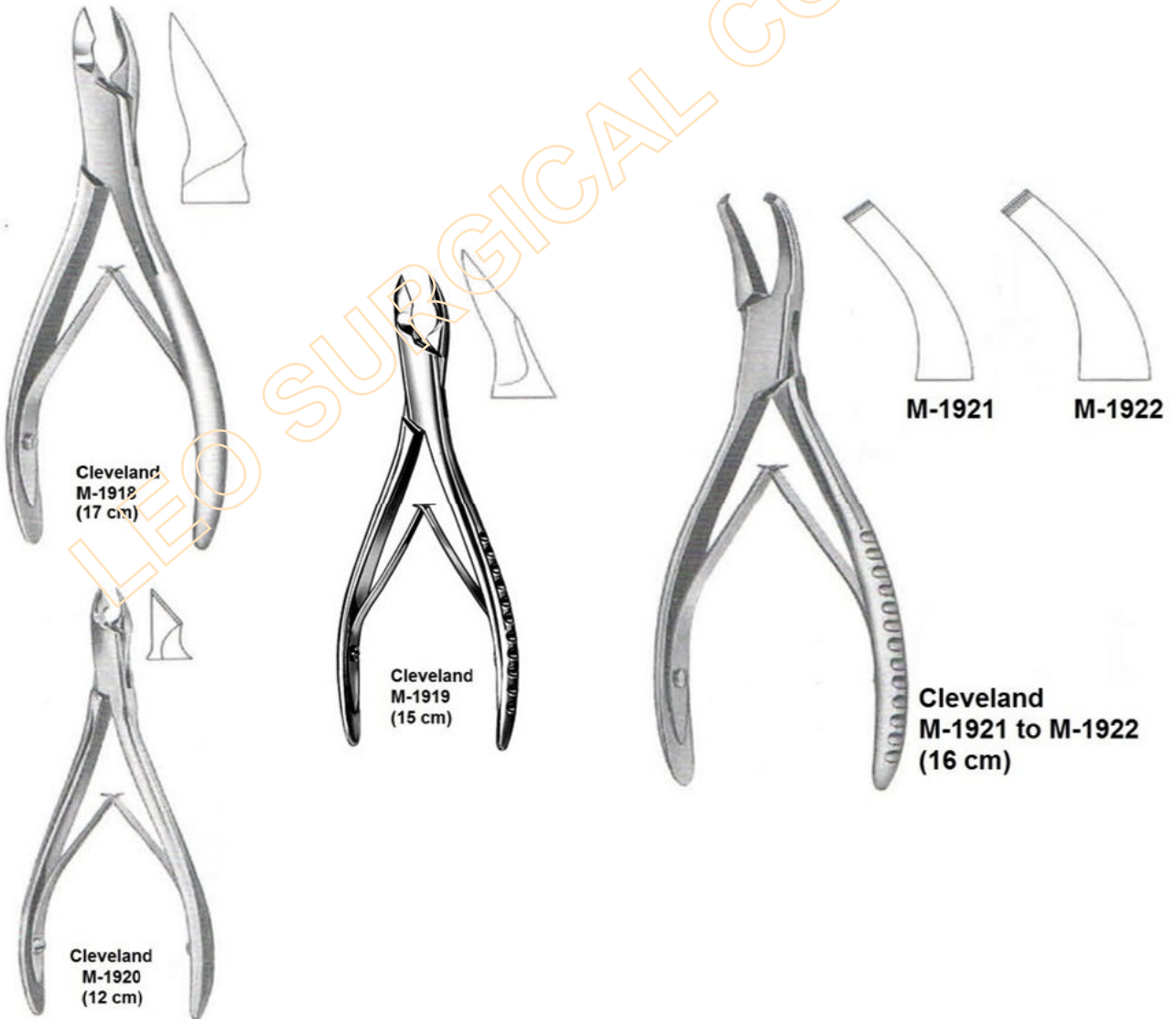
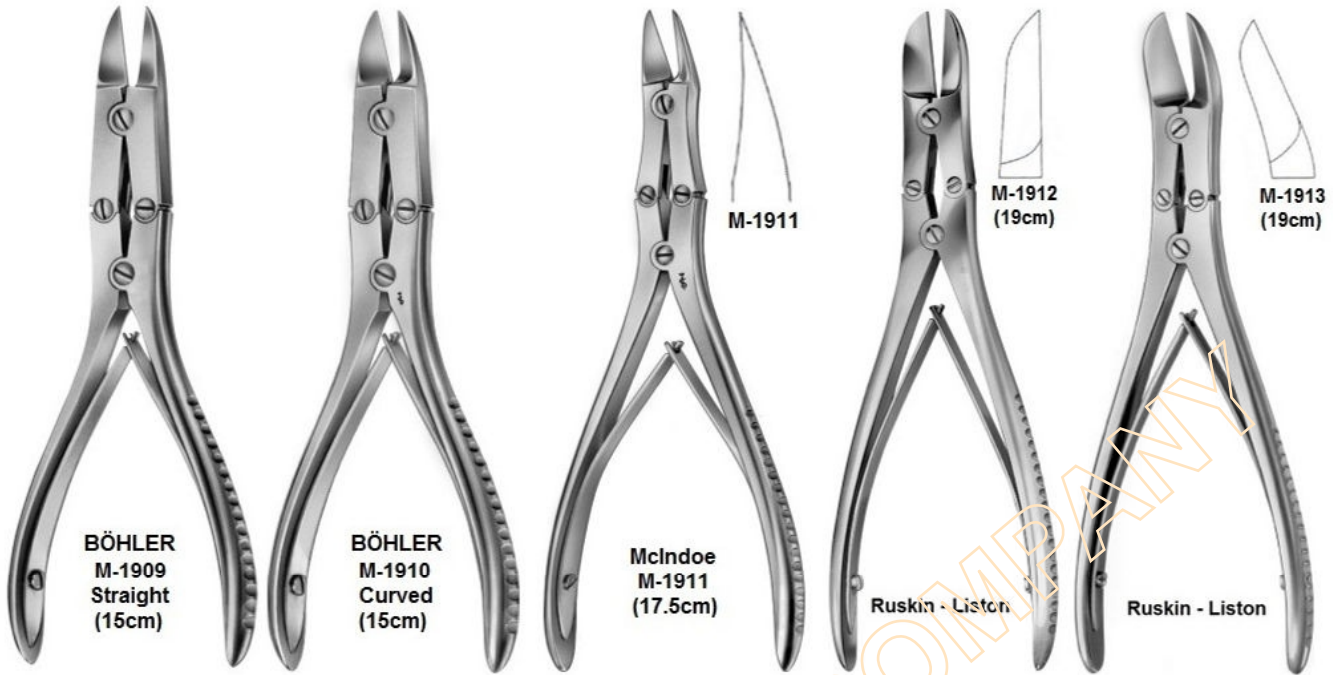

## BONE RONGEUR FORCEPS

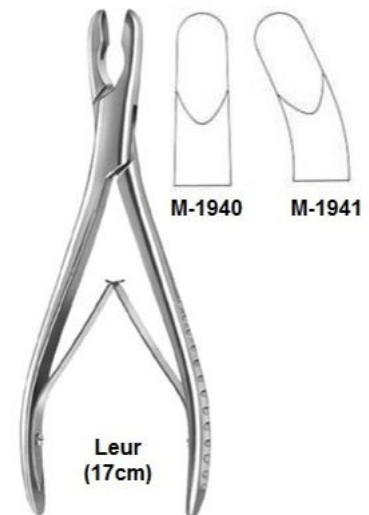
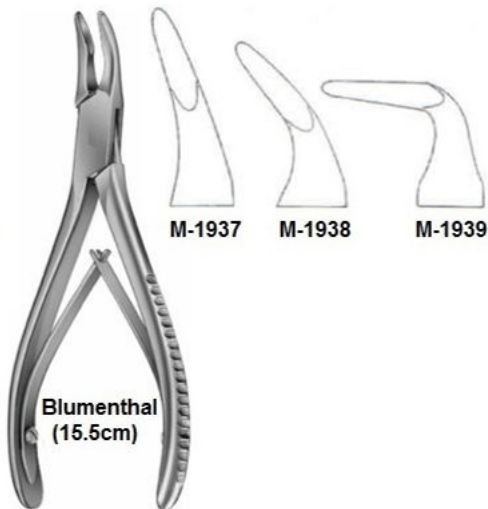
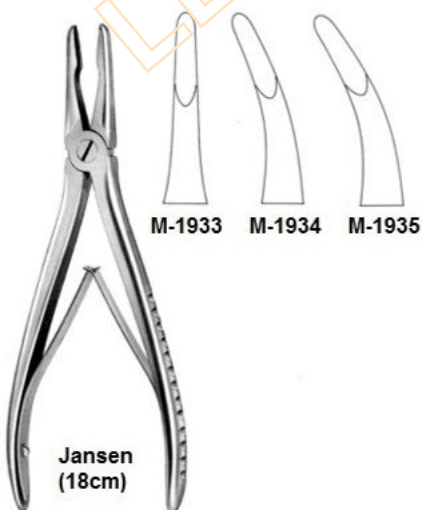
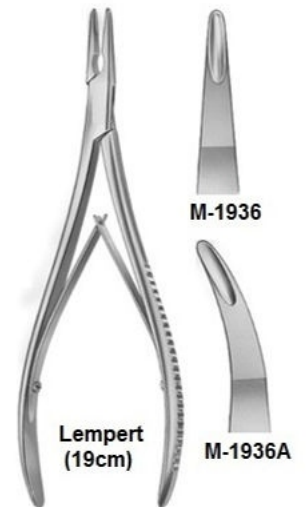
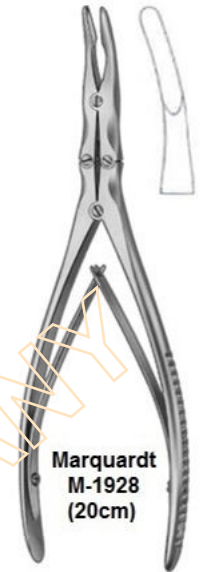

## LEYLA BRAIN RETRACTOR SYSTEM



M-6035





Serving the Humanity Since 1969



## LEO SURGICAL COMPANY

Manufacturers & Exporters of Surgical Instruments  
Near Octroi Post 10, Kala Singha Road,  
Basti Sheikh, Jalandhar-2 (Punjab) INDIA

 (M) +91-98720-09947

 (M) +91-95696-50007

 leosurgicalcompany

Website : [www.leosurgicalcompany.in](http://www.leosurgicalcompany.in)

E-mail : [leosurgicalco@gmail.com](mailto:leosurgicalco@gmail.com)

ISO : 13485:2016 | SSI | MSME | CE CERTIFIED



**DIAGNOSTIC  
SCISSORS  
FORCEPS  
CLAMPS  
NEEDLE HOLDERS  
TISSUE FORCEPS  
OPHTHALMIC  
PLASTIC SURGERY  
NEURO SURGERY  
RETRACTORS  
ENT  
DERMAL  
RECTAL  
ORTHOPEDIC  
GYNECOLOGICAL  
OBSTETRICAL  
HOLLOW WARES**